

TABLE OF CONTENTS

	A			M
ANSI Standards.....		2	Mortar Box.....	11
	B			P
Bearing at Top		12	Painted Cover Channels.....	6
Bearing Replacement Kit.....		14	Polished Cover Channels.....	6
	C			Q
Cancellation Notification		2	Quick Connect.....	9
Center Punches		14	Quick Ship.....	2
Concealed Electric Hinges with Lead Wire.....		7-10		R
Concealed Electric Monitoring (EMN).....		7-10	Replacement Moldings	11
Concealed Electric Through-Wire (ETW).....		7-10		S
Concealed Electric Through-Wire - Removable (RETW)		7-10	Shim Stock.....	15
Concealed Electric Through-Wire and Monitoring (ETM)		7-10	Shipping Cartons	15
Custom Hole Pattern		12	Short Hinges.....	12
	D		Special Anodizing	6
Dutch Door Prep		14	Special Cover Channels	5
	E		Special Finished Hinges.....	6
Electric Power Transfer Preparation (EPT).....		9	Special Holes	6
Electrical Modifications		7-10	Special Lengths	3
Exposed Electric Contacts (E).....		7-10	Special Products.....	3
Exposed Electric Switches (EIS).....		7-10	Standard Finishes.....	3
Extra Long Hinges.....		12	Standard Lengths.....	3
Power Transfer Preparation.....		9		T
	F		Tamper Resistant Hinge.....	14
Fasteners.....		15	Template Hinges.....	3
Field Modifications.....		3	TIPIT®	13
Fire Ratings		4		
	H			
Hinges				
Concealed.....		16, 17, 19-23, 24, 26-27, 29		
Full Surface.....		16, 19, 23-25, 28		
Half Surface		16-19, 23, 25, 28		
Hospital Tip.....		13		
How To Order		2		
	L			
Lead Times		2		
Length Specifications.....		3		



Roton Continuous Hinges

HOW TO ORDER:

Example: 780-112HDFFUL 119" CLR 1 PK
Stock Number: 184038
Item Number: YS 1121190CLR000001 Rev. S



INTRODUCTION

Hager Roton hinges are unique, aluminum geared hinges developed to outperform most other entrance components because the weight of the door is distributed along the full length of the door frame.

Roton continuous hinges have been utilized in hospitals, schools, hotels, offices, airports, stadiums, storefronts, and commercial and industrial buildings in new construction and retrofit applications for over 30 years.

Hager Roton continuous geared hinges are designed for superior performance. Because of this, we offer our lifetime warranty with confidence.

ANSI Standards

- 780 Series Roton continuous geared hinges are approved per ANSI A156.26 Grade 1 for 150 lb. doors
- 780 Series Roton heavy duty hinges are approved per ANSI A156.26 Grade 1 for 300 lb. doors
- 780-111, 780-112, 780-124HD, 780-224, 780-226 standard duty and heavy duty Roton continuous geared hinges are Warnock-Hersey certified in accordance with ANSI A250.13 2003 Standard Severe Windstorm Resistant Components.



Lead Times

Stock items will typically ship in five working days or less from the order entry date. Made-to-order items will typically ship in 15 working days depending on seasonal volume and order complexity. Special orders including industrials, special machining, and large quantities may need to be scheduled. The anticipated ship date will be included with each order acknowledgement. Please contact Customer Service if product availability is in question.

Quick Ship

Products denoted with **red and bold** pricing are available to order through the Quick Ship program and ship within 24 hours. When ordering these products please visit www.hagerco.com and log in to MyHager to access the 'Quick Ship' portal. Due to the promptness of the fulfillment process, Quick Ship orders are non-cancellable.

Cancellation Notification

Cancellation for made to order items must be completed within 48 hours of order placement.

Standard Lengths

Roton hinges are listed and priced as actual lengths 79" (6'8" opening), 83" (7'0" opening), 85" (7'2" opening), 95" (8'0" opening), and 119" (10'0" opening) for convenience in application to nominal sized doors. Actual length provides for threshold clearance, head clearance and door height allowances for carpeting. Other lengths may be ordered as non-standard items.

Special Lengths

Should a non-standard length be required, please price as the next standard length. (For example, if 86" length is required, use 95" list price.)

Length Specifications

If special lengths to match the actual net door heights are required, please indicate this clearly on your order. A special length should be specified from the net door height, not the nominal height of the opening. To order specify: "Actual Length", or "Net Door Height". Use pricing for the next longer standard length from which the special length can be manufactured. For example, hinges 86-3/4" long will be invoiced at the 95" price.

Field Modifications

While Roton hinges can be cut in the field, any product modifications may void all warranties. Should in-the-field modifications be required, cut only from bottom of hinge. Do not cut through bearings or screw holes. When cutting electric hinges it is extremely important to clamp both hinge leaves securely to prevent hinge "chatter" which can damage the hinge's internal wiring. Consult the St. Louis sales office before proceeding.

Template Hinges

Hager has developed templated hole patterns for Roton hinge models in standard lengths. Drawings are available upon request by contacting Hager Customer Service or accessing the Hager website at www.hagerco.com.

Due to normal variances inherent in the manufacturing process, Roton custom length hinges are deemed by Hager to be non-templated.

Standard Finishes

Roton hinges are available in clear anodized satin aluminum (similar to US28), dark bronze and black exterior anodized coating.

Special Products

A special product is any product not listed in the price book in regard to length, finish, standard hole preparation or leaf combinations not illustrated. Orders for special products are encouraged, but any changes or cancellations on special orders may result in charges related to work performed and/or material loss. Under no circumstance will non-stock or make-to-order products be accepted for return unless due to Hager error.



Roton Continuous Hinges

FIRE RATINGS - UNDERWRITERS LABORATORY FIRE RATING FILE #A14627



780 Series Roton continuous geared hinges with stainless steel studs are approved for use on 4'x10' metal or wood swing type doors. 780 Series Roton continuous geared hinges without stainless steel studs are approved for use on 4'x8' single swing metal doors and 4'x10' single swing wood doors used without stainless steel studs limited to 20 minute fire rating without hose stream.

- Hollow metal, tin-clad, sheet-metal and steel covered composite type rated up to and including 3 hours
- Wood composite doors rated up to and including 1-1/2 hours
- Wood core doors rated up to 20 minutes without hose stream, non-studded
- 780 Series Roton Continuous Geared Hinges meet requirements for positive pressure UL10C, UL10B and UBC7-2 Part 1

UL10C Fire Rated Roton	Fully Concealed	Full Surface	Half Surface	NOTES: 1. All Roton hinges will be marked with UL stamp if they are fire-rated. 2. Several hinge models cannot be fire-rated. Check each profile. 3. Models that require studs have an extra charge. Four studs are required for UL stud hinges. Add to the hinge list price before applying buying group discount - add \$56.80 .
20 Minute Fire Rated Wood Core Door x Fire Rated Hollow Metal Frame	UL — FF STANDARD			
20 Minute Fire Rated Metal Door x Fire Rated Hollow Metal Frame	UL — FF STANDARD			
30 Minute Fire Rated Wood Composite Door x Fire Rated Hollow Metal Frame	UL — FF STANDARD			
30 Minute Fire Rated Metal Door x Fire Rated Hollow Metal Frame	UL — FF STANDARD			
45 Minute Fire Rated Wood Composite Door x Fire Rated Hollow Metal Frame	UL — FF STANDARD			
45 Minute Fire Rated Metal Door x Fire Rated Hollow Metal Frame	UL — FF STANDARD			
60 Minute Fire Rated Wood Door x Hollow Metal Frame	UL — FF STANDARD			
60 Minute Fire Rated Metal Door x Hollow Metal Frame	UL — FF STANDARD			
90 Minute Fire Rated Metal Door x Fire Rated Hollow Metal Frame	UL — FF STANDARD			
90 Minute Fire Rated Wood Composite Door x Fire Rated Hollow Metal Frame	UL — STUD REQUIRED * Must Specify			
3 Hour Fire Rated Metal Door x Fire Rated Hollow Metal Frame	UL — STUD REQUIRED * Must Specify			

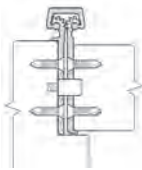

FULLY CONCEALED WITH STUD

Fully Concealed

These models are concealed between the frame and the hinge edge of the door. Models available include: 780-041HD, 780-041LL, 780-111, 780-111HD, 780-111LL, 780-112, 780-112HD, 780-112LL, 780--124HD, 780-124LL, 780-224, 780-224HD, 780-224LL, 780-226, 780-226HD, 780-226LL, and 780-235HD.

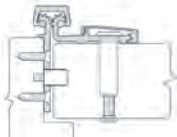

HALF SURFACE WITH STUD

Half Surface

These models have the frame leaf concealed between the frame and the edge of the door. The door leaf is mounted to the door with thru-bolts or screws. Models available include: 780-045HD, 780-046HD, 780-053, 780-053HD, 780-054HD, and 780-211HD.

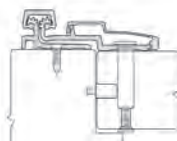

FULL SURFACE WITH STUD

Full Surface

These models have the frame leaf mounted to the face of the frame and the face of the door. The door leaf is mounted to the face of the door with thru-bolts. Models available include: 780-057HD, 780-157, 780-157HD, 780-210, 780-210HD, and 780-257HD.



MODIFICATIONS & ADDITIONS

Special Cover Channels

Rounded back cover channels may be ordered. Availability for hinges with electrical modifications vary.

Please consult the St. Louis sales office for confirmation. Add to the hinge list price before applying buying group discount:

Round Back Cover Channels

Clear Anodized

79", 83", 85"	\$26.70
95"	\$33.10
119"	\$42.60

Bronze Anodized

79", 83", 85"	\$53.25
95"	\$59.60
119"	\$68.15

Black Anodized

79", 83", 85"	\$61.25
95"	\$68.60
119"	\$78.40

Note: Special cover channels available in clear, dark bronze and black finish.

Roton Cover Channel Compatibility		
Hinge Model	Flat FBCC	Round RBCC
750-134	•	
750-138	•	
780-041	•	•
780-045	•	•
780-046	•	•
780-053	•	•
780-054	•	•
780-057	•	•
780-110	•	•
780-111	•	•
780-112	•	•
780-113	•	•
780-124	•	•
780-155	•	•
780-157	•	
780-210	•	•
780-211	•	•
780-213	•	•
780-224	•	•
780-226	•	•
780-235	•	•
780-259	•	•
780-300	•	

* Round back (RBCC) is not compatible with molded Hospital Tip option.



Roton Continuous Hinges

MODIFICATIONS & ADDITIONS PRICE

ADDITION TO LIST

Bone White Painted Cover Channels

For hinges 79", 83" and 85" in length

\$63.95

For hinges 95" in length

\$87.30

For hinges 119" in length

\$129.80

Roton cover channels are offered in bone white as a standard stock color option. This is only available on the standard Roton cover channel and should be ordered as bone white paint # UC43350.

Polished Cover Channels

CLEAR

GOLD

For hinges 79" in length

\$63.95

\$87.30

For hinges 83" in length

\$63.95

\$87.30

For hinges 85" in length

\$63.95

\$87.30

For hinges 95" in length

\$87.30

\$108.50

For hinges 119" in length

\$128.70

\$148.90

Any hinge may be ordered with a polished clear cover channel (similar to US26) to complement clear anodized hinge leaves or a polished gold cover channel (similar to US3) to complement satin gold hinge leaves.

Special Finished Hinges

Price on Application

Hager Companies can supply unfinished material to selected finishers for special projects that require unusual colors, but will require that final assembly be complete by Hager Companies. Because of special non-removable metal coatings applied to all hinges during assembly, users are cautioned against attempting to refinish any Roton product. Lead time of up to 10-12 weeks may be required.

Cannot paint 500 or 1200 series hinges.

Special Anodizing

Add 20% to the DBA hinges for gold

Roton hinges are available in various special colors including Black, Gold, and other special anodized finishes with fasteners to match. Example, specify "Black Anodized" or "Gold Anodized." All hinges ordered in special colors should be ordered at the same time to guarantee finish uniformity.

Other anodized colors by quotation only. Supply color chip for best match.

Special Holes

Price on Application

Any hinge may be ordered with special hole locations for unusual frame or door locations. Please provide specification for each leaf.



ROTON ELECTRICAL MODIFICATIONS

- A = Opening
- B = Door height
- C = Actual hinge length
- D = C.L. of EMN (electric monitor)
- E = C.L. of ETM (electric through-wires & monitor)
- F = C.L. of ETW (electric through-wires)
- G = C.L. of EPT (electric power transfer)
- H = C.L. of E1S (exposed switch)
- J = C.L. of E (exposed contact)
- K = C.L. of RETW (removable electric through-wires)

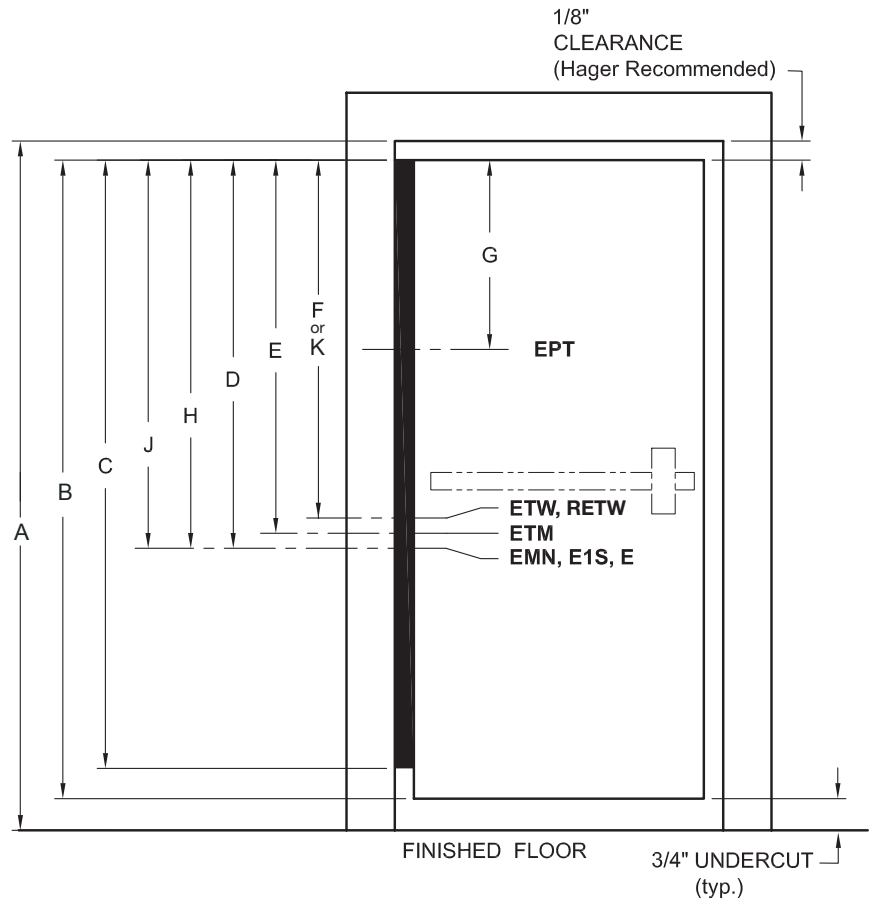

For ease of ordering, Hager Companies has established standard locations for power transfer cutouts. All standard location dimensions are referenced from the top edge of the door to the centerline of the power transfer cutout. Please specify handing.

NOTE: These locations are for concealed hinges only.

	Opening	Door Height	Actual Hinge Length	EMN	ETM	ETW	EPT	E1S	E	RETW
79 SD	80"	79-1/8"	79"	40-3/4"	42-3/4"	40-3/4"	34-3/8"	42-1/2"	42-1/2"	-
79 HD	80"	79-1/8"	79"	40-3/4"	43-3/8"	40-3/4"	34-3/8"	42-1/2"	42-1/2"	43-3/8"
83 SD	84"	83-1/8"	83"	45-5/16"	44-3/4"	45-5/16"	36-3/8"	46-1/2"	46-1/2"	-
83 HD	84"	83-1/8"	83"	45-5/16"	45-3/8"	45-5/16"	36-3/8"	46-1/2"	46-1/2"	45-3/8"
85 SD	86"	85-1/8"	N/A	N/A	N/A	N/A	N/A	N/A	N/A	N/A
85 HD	86"	85-1/8"	85"	46-5/16"	46-3/8"	46-5/16"	37-3/8"	48-1/2"	48-1/2"	46-3/8"
95 SD	96"	95-1/8"	95"	56-3/8"	55-13/16"	56-3/8"	47-1/2"	59-3/4"	59-3/4"	-
95 HD	96"	95-1/8"	95"	56-3/8"	56-1/2"	56-3/8"	47-1/2"	59-3/4"	59-3/4"	56-1/2"
119 SD	120"	119-1/8"	N/A	N/A	N/A	N/A	N/A	N/A	N/A	N/A
119 HD	120"	119-1/8"	119"	81-1/4"	81-5/16"	81-1/4"	72-5/16"	83-3/4"	83-3/4"	81-5/16"

SD = Standard Duty

HD = Heavy Duty



Roton Continuous Hinges

ROTON ELECTRICAL MODIFICATIONS (CONTINUED)

	Von Duprin EPT 2 or EPT 10 Power Transfer Preparation	Exposed Electric Contacts	Exposed Electric Switches	Concealed Electric Through-Wire	Concealed Electric Monitoring	Concealed Electric Through-Wire and Monitoring	Removable Electric Through-Wire
Part Number	EPT	E	E1S	ETW	EMN	ETM	RETW
780-045HD	•						
780-046HD	•						
780-053	•						
780-053HD	•						
780-054HD	•						
780-110HD			•				
780-057				•			•
780-111	•	•	•	•	•	•	
780-111HD	•	•	•	•	•	•	•
780-111LL	•	•	•	•	•	•	
780-112	•	•	•	•	•	•	
780-112HD	•	•	•	•	•	•	•
780-112LL	•	•	•	•	•	•	
780-124HD	•	•	•	•	•	•	•
780-124LL	•	•	•	•	•	•	
780-157				•			•
780-224	•	•	•	•	•	•	
780-224HD	•	•	•	•	•	•	•
780-224LL	•	•	•	•	•	•	
780-226HD	•	•	•	•	•	•	•
780-226LL	•	•	•	•	•	•	
1200-600	•			•			
1200-650	•			•			



**MODIFICATIONS & ADDITIONS
PRICE**

ADDITION TO LIST

Quick Connect

\$47.90

Available for ETM, ETW, and RETW options. Top and bottom knockouts for standard conduit fittings.

Concealed Electric Monitoring (EMN)

\$268.40

- Miniature switch is incorporated into the frame leaf.
- Specify handing and the dimension from the top edge of the door to the centerline of the electric monitoring location.
- Special Electric Modifications and EPT locations may require additional charges if screw holes have to be moved.
- Templates regarding location of monitoring switch available upon request.

Concealed Electric Through-Wire and Monitoring (ETM)

- Electric Preparation

ETM-4 **\$535.70**

ETM-8 **\$621.80**

ETM-10 **\$662.25**

- All ETM have 28-Gauge continuous conductors.
- This combines the continuous electric conductors and the miniature switch to provide both power transfer and monitoring.
- Miniature switch is incorporated into the frame leaf.
- Specify handing and the dimension from the top edge of the door to the centerline of each electric modification location.
- Templates regarding location of monitoring switch available upon request.

Concealed Electric Through-Wire (ETW)

- Electric Preparation

ETW-4 **\$268.40**

ETW-8 **\$349.40**

ETW-10 **\$398.00**

ETW-12 **\$445.40**

- All ETW have 28-Gauge continuous conductors.
- 12" per side required as a suffix.
- Cut out for prep - 1/2" drilled hole.
- Transfers power discreetly from building to door hardware.
- Specify handing and the dimension from the top edge of the door to the centerline of the electric through-wire location.
- Special electric modifications and EPT locations may require additional charges if screw holes have to be moved. Contact Hager Customer Service for charges.
- Templates regarding location of through-wires available upon request.

Available on the following Roton profiles:

- 780-057HD • 780-112HD • 780-157HD • 780-226HD • 1200-650HD
- 780-111HD • 780-124HD • 780-224HD • 1200-600HD

Power Transfer or Electric Power Transfer Preparation (EPT)

Concealed Leaf **\$104.40**

Half Surface **\$62.90**

- Hinge leaf cutout to accommodate power transfer device.
- Specify handing and the dimension from the top edge of the door to the **centerline** of the power transfer location.
- Special Electric Modifications and EPT locations may require additional charges if screw holes have to be moved.



Roton Continuous Hinges

MODIFICATIONS & ADDITIONS PRICE

ADDITION TO LIST

Lead Wire for Concealed Electric Hinges

Electric Preparation

4-wire hinge

8-wire hinge

10-wire hinge

- Standard wire leads are 12" per side
- Additional wire leads are available

Per Foot

\$9.25

\$16.80

\$19.05

Exposed Electric Switches (E1S)

\$93.80

- Miniature push button switch incorporated in hinge frame leaf to monitor position of the door.
- Three 12" wire leads.
- Each monitoring hinge only needs one E1S Switch.
- Specify handing and the dimension from the top edge of the door to the centerline of the electric switch location.
- Templates regarding location of contact switch available upon request.

Exposed Electric Contacts (E)

\$93.80

- Transfers power to door in closed position.
- Must have at least two (2) contacts to transfer power.
- Specify handing and the dimension from the top edge of the door to the centerline of the electric contact location.
- Templates regarding location of contacts available upon request.

Removable Electric Through-Wire (RETW) Twelve Wire

\$651.45

Removable 12 Wire Module Only

\$265.65

Component

Finish

7-102-1870

Clear

7-112-1872

Dark Bronze

7-112-1876

Gold

7-112-1881

Black

Removable Electric Through-Wire (RETW) Ten Wire

\$552.10

Removable 10 Wire Module Only

\$214.90

Component

Finish

7-102-1860

Clear

7-112-1870

Dark Bronze

7-112-1875

Gold

7-112-1880

Black



Available on heavy duty profiles:

- 780-057HD
- 780-112HD
- 780-157HD
- 780-226HD
- 780-111HD
- 780-124HD
- 780-224HD

- Transfers power discreetly from building to door hardware.
- Removable ETW module can be easily removed for adjustment for service.
- Templates regarding location of monitoring switch available upon request.
- Specify handing and the dimension from the top edge of the door to the centerline of the electric through-wire location.

MODIFICATIONS & ADDITIONS

Mortar Box - 430

\$47.90

- Serves as a mortar shield.
- Overall dimensions: 9" (229 mm) length with tabs, 7" (178 mm) inside, 1-3/4" x 1-3/4" (45 mm x 45 mm) inside dimension.
- Galvanized steel 0.040" (1 mm)

**Replacement Molding
780-052M**

Hinge Lengths

79", 83", 85"
95"
119"

Clear Anodized

\$38.60
\$44.60
\$53.25

Dark Bronze Anodized

\$44.60
\$53.25
\$61.80

Replacement door leaf molding for: 780-053, 780-053HD, 780-054HD, 780-155HD, 780-057HD, 780-157, 780-157HD, 780-257HD, and 780-259HD.

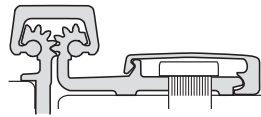

**Replacement Molding
780-210M**

Hinge Lengths

79", 83", 85"
95"
119"

Clear Anodized

\$40.60
\$50.20
\$58.80

Dark Bronze Anodized

\$50.20
\$58.80
\$66.45

Replacement door leaf molding for: 780-210, 780-210HD, 780-211, 780-211HD, 780-213HD, 780-045HD, and 780-046HD.

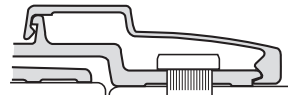

**Replacement Molding
780-247M**

Hinge Lengths

79", 83", 85"
95"
119"

Clear Anodized

\$34.50
\$40.60
\$50.20

Dark Bronze Anodized

\$40.60
\$50.20
\$58.80

Replacement frame leaf molding
780-157, 780-157HD, 780-257HD

Note: Replacement moldings for 780-052M and 780-210M are shipped in stock lengths for trimming in the field and furnished with Allen head set screw and wrench.

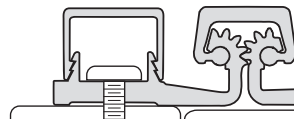

Roton Continuous Hinges

MODIFICATIONS & ADDITIONS PRICE

ADDITION TO LIST

Short Hinges

\$22.30

Hinges shorter than 79" will be invoiced at the 79" price. Where two or more short hinges can be obtained from a standard length, pricing is based on the number of standard lengths utilized plus an assembly charge for each hinge.

Extra Long Hinges

\$97.50

Hinges over 119" are manufactured as two separate lengths with a staggered joint for on-site connection. Hinge segments are taken from standard sizes for best economics in relation to the quantity required. Hanging specifications are required to position the cuts inconspicuously and to finish symmetrical pairs in double door applications.

Custom Hole Pattern

Price on Application

Any hinge may be ordered with special hole locations for unusual frame or door conditions. Please provide specifications for each leaf.

Bearing At Top

\$41.50

This application allows for the bearing to be set at the very top of the cover channel. The cover channel is flush with the top of the geared hinge, preventing any obstructions or debris from being inserted in the top of the channel.

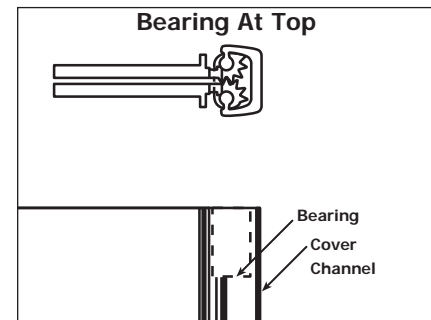

780 Series Concealed Molded Hospital Tip

\$122.50

780 Series Concealed and several Full Surface models can be prepared with a smooth tapered top bearing. This option is ideal for use in hospitals and correctional facilities to help provide a clean and safe environment. For Roton® Ligature-Resistant Opening Solutions see our TIPIT® section below. Not compatible with the round back cover channel option. For complete list of compatible models for this option, please reference chart on page 13.



Hospital Tip and TIPIT® Compatibility		
Part #	Molded Hospital Tip	TIPIT®
750-134		•
750-138		•
780-045		•
780-046		•
780-053		•
780-054		•
780-057	•	
780-110	•	•
780-111	•	•
780-112	•	•
780-113	•	•
780-124	•	•
780-155		•
780-157	•	•
780-210	•	•
780-211		•
780-224	•	•
780-226	•	•



Roton Continuous Hinges

MODIFICATIONS & ADDITIONS

TIPIT®

Designed to work with in new and retrofit applications, the TIPIT® was designed with safety in mind. When openings are fitted with the patented TIPIT® in conjunction with our Roton® Continuous Geared Hinge, this combination provides a safe environment while meeting institutional requirements for preventing objects from being hung from the top of the hinge.

Concealed

\$58.00



Full Surface (Gray or Black)

\$147.00



Tamper Resistant Hinge

\$143.80

This application is intended for use in hospital psychiatric areas and places of high security. The hinge is **prepared with a hospital tip** and every other bearing is supplied with a set screw to lock against the inside of the cover channel for additional security. 780 Series Concealed and Full Surface models (780-057, 780-157, and 780-210) are available in this configuration. Torx screws available at additional charge (see page 15).

Dutch Door Prep

\$85.15

Furnished as continuous frame leaf, whole door leaf is cut to fit dutch door specified length.

Bearing Replacement Kit

Standard Duty for 780 Series

Heavy Duty for 780 Series

Extra Heavy Duty for 1200 Series

Clear and Dark Bronze

\$43.65

\$83.10

\$165.15

Center Punches

Self-Centering center punches are available for #12 countersunk screws supplied. To make sure screw heads seat properly, accurate center punching is required.

\$9.75

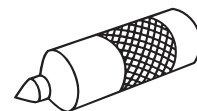

**MODIFICATIONS & ADDITIONS
PRICE**

ADDITION TO LIST

Shim Stock

1/16" x 1-1/2" Wide x 7' Long

1/8" x 1-1/2" Wide x 7' Long

\$33.60 each

\$46.85 each

Larger sizes available

Price on application

For clearance between the door and frame which may be excessive, a continuous shim is helpful (applied behind the frame leaf only). Anodized aluminum extrusions are supplied with no holes.

Shipping Carton

\$23.45 each

Extra shipping cartons are available for reshipping hinges in quantities of 2 or less.

Fasteners

All hinges are shipped with appropriate fasteners for metal doors and frames except where noted. **If wood screws are required, please specify on order, and wood screws will be substituted at no extra charge.** Bulk screws are packed separately.

Description	Part Numbers		
	Clear	Dark Bronze	
#12 x 1-1/2" Flat Head Wood Screw	7-080-0050	7-080-0051	\$259.70/box of 500
#12-24 x 11/16" Self-Drilling Flat Head Screw	7-080-0070	7-080-0072	\$232.20/box of 500
#12-24 x 1/2" Spanner Head Machine Screw			\$2.10 each
#12-24 x 11/16" Drill Quick Torx Screw			\$2.10 each
#12-24 x 13/32" Self-Threading Screw (Clear or Bronze)			\$0.85 each
#12-24 x 11/16" Self-Drilling Flat Head Screw (Clear or Bronze)			\$1.20 each
#12-24 x 11/16" Self-Drilling Pan Head Screw (Clear)			\$1.20 each
#12 x 1-1/2" Flat Head Wood Screw (Clear or Bronze)			\$1.20 each
Sexbolts			\$3.10 each

Note: Additional fasteners may be ordered as follows (add to the hinge list price before applying buying group discount).



Roton Continuous Geared Hinges

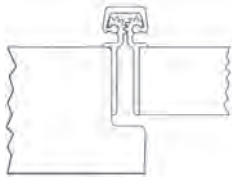

Description		Finish	2021 List	Stock No.	Case Qty.
500-048 Concealed Leaf With Sheet Metal Screws 1-1/6" Nominal Leaf Thickness	24" (610 mm)	Clear	73.85	068560	1
		Dark Bronze	98.40	068046	
	36" (914 mm)	Clear	83.65	068521	1
		Dark Bronze	110.75	-	
	48" (1219 mm)	Clear	98.40	068520	1
		Dark Bronze	123.00	067970	
72" (1829 mm)	Clear	123.00	068509	1	
	Dark Bronze	147.60	067969		

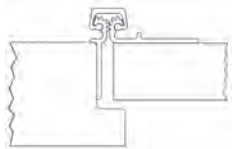

500-200 Half Surface With Sheet Metal Screws 1-1/6" Nominal Leaf Thickness	24" (610 mm)	Clear	73.85	067967	1
		Dark Bronze	98.40	067559	
	36" (914 mm)	Clear	86.15	067964	1
		Dark Bronze	110.75	067431	
	48" (1219 mm)	Clear	98.40	067961	1
		Dark Bronze	123.00	-	
72" (1829 mm)	Clear	123.00	067959	1	
	Dark Bronze	147.60	067266		

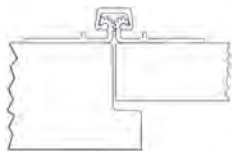

500-220 Full Surface With Sheet Metal Screws 1-1/6" Nominal Leaf Thickness	24" (610 mm)	Clear	73.85	067944	1
		Dark Bronze	98.40	-	
	36" (914 mm)	Clear	86.15	067940	1
		Dark Bronze	110.75	067009	
	48" (1219 mm)	Clear	98.40	067939	1
		Dark Bronze	123.00	067001	
72" (1829 mm)	Clear	123.00	067938	1	
	Dark Bronze	147.60	067000		

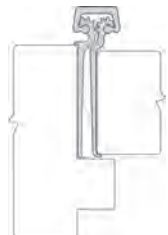

750-134 Concealed Leaf With Half Drill Quick and Half Wood Screws 1-3/4" Interior Wood Door	79" (2007 mm)	Clear	159.15	194853	8
	83" (2108 mm)	Clear	159.15	194855	8
	85" (2159 mm)	Clear	159.15	194859	8
	95" (2413 mm)	Clear	202.40	194861	8
	119" (3023 mm)	Clear	313.25	194863	6

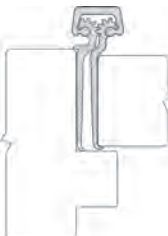

750-138 Concealed Leaf With Half Drill Quick and Half Wood Screws 1-3/8" Interior Wood Door	79" (2007 mm)	Clear	161.95	194890	8
	83" (2108 mm)	Clear	161.95	194897	8
	85" (2159 mm)	Clear	161.95	194909	8
	95" (2413 mm)	Clear	198.10	-	8
	119" (3023 mm)	Clear	305.50	-	8

Roton Continuous Geared Hinges

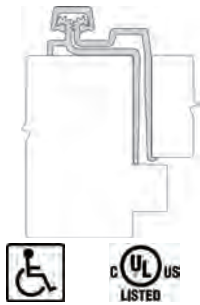

Description	Finish	2021 List	Stock No.	Case Qty.
780-041HD Concealed Leaf Heavy Duty 1-3/4" Door Swing Clear Action	79" (2007 mm) Clear	362.40	194918	6
	Dark Bronze	481.00	194919	
	Black	533.20	-	
	83" (2108 mm) Clear	362.40	194803	6
	Dark Bronze	481.00	194920	
	Black	553.20	-	
	85" (2159 mm) Clear	362.40	194921	6
	Dark Bronze	481.00	194923	
	Black	533.20	-	
95" (2413 mm) Clear	449.20	194805	6	
Dark Bronze	591.70	194924		
Black	680.40	-		
119" (3023 mm) Clear	670.50	194925	2	
Dark Bronze	881.90	194926		
Black	1,014.20	-		

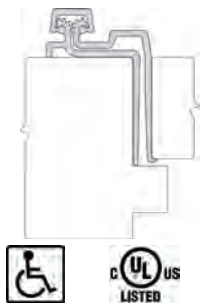

780-041LL Concealed Leaf With Half Drill Quick and Half Wood Screws 1-3/4" Door Lead Lined Heavy Duty Profile Only Swing Clear Action	79" (2007 mm) Clear	376.90	187432	6
	Dark Bronze	493.00	-	
	Black	567.00	-	
	83" (2108 mm) Clear	376.90	022711	6
	Dark Bronze	493.00	073552	
	Black	567.00	-	
	85" (2159 mm) Clear	376.90	095167	6
	Dark Bronze	493.00	-	
	Black	567.00	-	
95" (2413 mm) Clear	461.30	-	6	
Dark Bronze	603.70	-		
Black	694.30	-		
119" (3023 mm) Clear	681.50	-	2	
Dark Bronze	894.00	-		
Black	1,028.10	-		

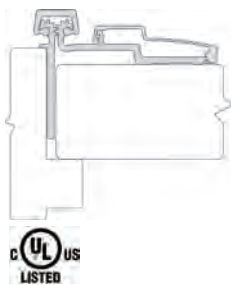

780-045HD Half Surface Heavy Duty	79" (2007 mm) Clear	429.70	194937	4
	Dark Bronze	574.40	-	
	Black	660.60	-	
	83" (2108 mm) Clear	429.70	194938	4
	Dark Bronze	574.40	194939	
	Black	660.60	-	
	85" (2159 mm) Clear	429.70	194940	4
	Dark Bronze	574.40	194942	
	Black	660.60	-	
95" (2413 mm) Clear	528.20	194943	4	
Dark Bronze	706.50	194944		
Black	812.40	47150		
119" (3023 mm) Clear	786.90	194945	2	
Dark Bronze	1,051.00	194947		
Black	1,208.70	-		

1. Items with the price in **bold and red** are Quick Ship items and ship in 24 hours.
Please use stock number when ordering. 2. U/M is each unless otherwise noted.



Roton Continuous Geared Hinges

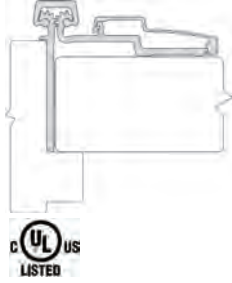

Description		Finish	2021 List	Stock No.	Case Qty.
780-046HD Half Surface Heavy Duty	79" (2007 mm)	Clear	462.50	194948	4
		Dark Bronze	606.70	-	
		Black	697.70	-	
	83" (2108 mm)	Clear	462.50	194949	4
		Dark Bronze	606.70	194950	
		Black	697.70	88082	
	85" (2159 mm)	Clear	462.50	194951	4
		Dark Bronze	606.70	197942	
		Black	697.70	-	
	95" (2413 mm)	Clear	567.10	194952	4
		Dark Bronze	754.10	194953	
		Black	867.20	-	
	119" (3023 mm)	Clear	847.20	99397	2
		Dark Bronze	1,122.70	81736	
		Black	1,291.10	-	
780-053 Half Surface	79" (2007 mm)	Clear	224.80	194464	5
		Dark Bronze	309.10	194990	
		Black	355.40	-	
	83" (2108 mm)	Clear	224.80	194991	5
		Dark Bronze	309.10	194992	
		Black	355.40	135666	
	95" (2413 mm)	Clear	278.50	194993	5
		Dark Bronze	376.70	194994	
		Black	433.20	199830	
780-053HD Half Surface Heavy Duty	79" (2007 mm)	Clear	282.00	194996	5
		Dark Bronze	353.70	194997	
		Black	406.80	66022	
	83" (2108 mm)	Clear	282.00	194998	5
		Dark Bronze	353.70	194999	
		Black	406.80	63779	
	85" (2159 mm)	Clear	282.00	195002	5
		Dark Bronze	353.70	195003	
		Black	406.80	-	
	95" (2413 mm)	Clear	349.90	195004	5
		Dark Bronze	423.90	195005	
		Black	487.50	199831	
119" (3023 mm)	Clear	535.60	195006	3	
	Dark Bronze	715.00	195007		
	Black	822.30	-		

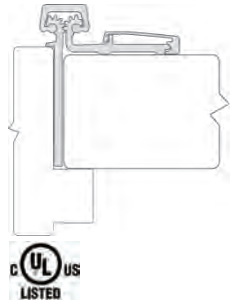
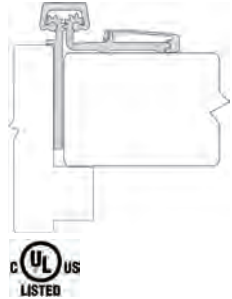

1. Items with the price in **bold and red** are Quick Ship items and ship in 24 hours. Please use stock number when ordering. 2. U/M is each unless otherwise noted.

Roton Continuous Geared Hinges

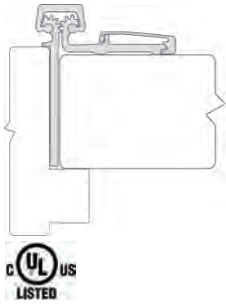

Description		Finish	2021 List	Stock No.	Case Qty.
780-054HD Half Surface Heavy Duty	79" (2007 mm)	Clear	308.00	195050	5
		Dark Bronze	378.80	195051	
		Black	435.60	-	
	83" (2108 mm)	Clear	308.00	195052	5
		Dark Bronze	378.80	195053	
		Black	435.60	80289	
	85" (2159 mm)	Clear	308.00	195054	5
		Dark Bronze	378.80	195055	
		Black	435.60	-	
95" (2413 mm)	Clear	380.80	195056	5	
	Dark Bronze	450.50	195057		
	Black	518.00	99659		
119" (3023 mm)	Clear	585.80	195058	3	
	Dark Bronze	756.10	195059		
	Black	869.50	72407		



780-057HD Full Surface Heavy Duty Bi-Fold Applications	79" (2007 mm)	Clear	329.00	021238	5
		Dark Bronze	464.60	017850	
		Black	534.30	-	
	83" (2108 mm)	Clear	329.00	007856	5
		Dark Bronze	464.60	025973	
		Black	534.30	-	
	85" (2159 mm)	Clear	329.00	025846	5
		Dark Bronze	464.60	174835	
		Black	534.30	-	
	95" (2413 mm)	Clear	418.30	024478	5
		Dark Bronze	575.20	094331	
		Black	661.50	-	
	119" (3023 mm)	Clear	623.50	088469	4
		Dark Bronze	856.70	165568	
		Black	985.20	-	



780-110HD Concealed Leaf Heavy Duty For 1" to 1-3/8" door	79" (2007 mm)	Clear	209.20	100071	8
		Dark Bronze	270.30	196487	
		Black	310.80	-	
	83" (2108 mm)	Clear	209.20	110418	8
		Dark Bronze	270.30	111266	
		Black	310.80	84514	
	85" (2159 mm)	Clear	209.20	112381	8
		Dark Bronze	270.30	173953	
		Black	310.80	63320	
	95" (2413 mm)	Clear	251.40	112392	8
		Dark Bronze	325.80	112393	
		Black	374.70	90279	
	119" (3023 mm)	Clear	398.20	112405	7
		Dark Bronze	522.90	112406	
		Black	601.40	91587	

1. Items with the price in **bold and red** are Quick Ship items and ship in 24 hours.
Please use stock number when ordering. 2. U/M is each unless otherwise noted.



Roton Continuous Geared Hinges

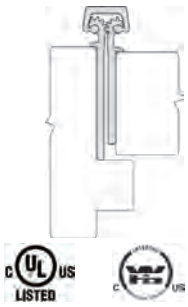

Description		Finish	2021 List	Stock No.	Case Qty.
780-111 Concealed Leaf	79" (2007 mm)	Clear	163.40	194809	8
		Dark Bronze	211.10	194810	
		Black	242.75	60918	
	83" (2108 mm)	Clear	163.40	184007	8
		Dark Bronze	211.10	184008	
		Black	242.75	80025	
	95" (2413 mm)	Clear	199.10	184031	8
		Dark Bronze	258.90	184048	
		Black	297.70	98769	

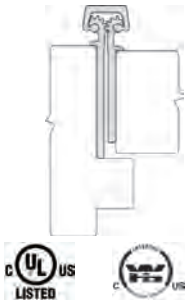

780-111HD Concealed Leaf Heavy Duty	79" (2007 mm)	Clear	203.30	183917	8
		Dark Bronze	265.50	194812	
		Black	305.40	-	
	83" (2108 mm)	Clear	203.30	183924	8
		Dark Bronze	265.50	183988	
		Black	305.40	116592	
	85" (2159 mm)	Clear	203.30	194814	8
		Dark Bronze	265.50	194815	
		Black	305.40	83711	
	95" (2413 mm)	Clear	246.80	184025	8
		Dark Bronze	319.20	194816	
		Black	367.10	109310	
	119" (3023 mm)	Clear	394.40	194817	7
		Dark Bronze	513.60	194819	
		Black	590.60	113845	



780-111LL Concealed Leaf With Half Drill Quick and Half Wood Screws Lead Lined Heavy Duty Profile Only	79" (2007 mm)	Clear	220.00	194848	8
		Dark Bronze	279.60	-	
		Black	321.60	-	
	83" (2108 mm)	Clear	220.00	195079	8
		Dark Bronze	279.60	195080	
		Black	321.60	-	
	85" (2159 mm)	Clear	220.00	-	8
		Dark Bronze	279.60	-	
		Black	321.60	-	
	95" (2413 mm)	Clear	261.50	195088	8
		Dark Bronze	333.20	195089	
		Black	383.20	-	
	119" (3023 mm)	Clear	405.00	-	7
		Dark Bronze	528.20	-	
		Black	607.50	-	

Roton Continuous Geared Hinges



Description		Finish	2021 List	Stock No.	Case Qty.
780-112 Concealed Leaf Single Pack w/ Drill Quick Screws	79" (2007 mm)	Clear	137.60	183922	8
		Dark Bronze	177.70	194822	
		Black	204.40	74006	
	83" (2108 mm)	Clear	137.60	184001	8
		Dark Bronze	177.70	184003	
		Black	204.40	136045	
	95" (2413 mm)	Clear	168.50	184032	7
		Dark Bronze	221.90	184033	
		Black	255.20	126429	
780-112 Concealed Leaf Case Pack w/ Drill Quick Screws Must Order Case Quantity	83" (2108 mm)	Clear	123.80	184009	8
		Dark Bronze	160.00	184010	
		Black	184.00	-	
780-112HD Concealed Leaf Single Pack w/ Drill Quick Screws	79" (2007 mm)	Clear	170.90	183881	8
		Dark Bronze	220.80	194826	
		Black	253.90	128859	
	83" (2108 mm)	Clear	170.90	183926	8
		Dark Bronze	220.80	183932	
		Black	253.90	110422	
	85" (2159 mm)	Clear	170.90	184011	8
		Dark Bronze	220.80	184013	
		Black	253.90	123296	
	95" (2413 mm)	Clear	205.90	184020	7
		Dark Bronze	271.50	184021	
		Black	312.20	123220	
	119" (3023 mm)	Clear	331.20	184038	7
		Dark Bronze	436.40	194827	
		Black	501.90	114187	
780-112HD Concealed Leaf Case Pack w/ Drill Quick Screws Must Order Case Quantity	83" (2108 mm)	Clear	156.40	109235	8
		Dark Bronze	198.80	80053	
		Black	228.60	183989	
780-112LL Concealed Leaf With Half Drill Quick and Half Wood Screws Lead Lined Heavy Duty Profile Only	79" (2007 mm)	Clear	188.50	195090	8
		Dark Bronze	246.40	-	
		Black	283.40	-	
	83" (2108 mm)	Clear	188.50	195091	8
		Dark Bronze	246.40	195092	
		Black	283.40	83861	
	85" (2159 mm)	Clear	188.50	195093	8
		Dark Bronze	246.40	-	
		Black	283.40	-	
	95" (2413 mm)	Clear	229.30	195094	8
		Dark Bronze	294.00	195095	
		Black	338.60	-	
	119" (3023 mm)	Clear	365.80	195096	7
		Dark Bronze	478.00	197874	
		Black	549.70	-	



1. Items with the price in **bold and red** are Quick Ship items and ship in 24 hours.
Please use stock number when ordering. 2. U/M is each unless otherwise noted.



Roton Continuous Geared Hinges

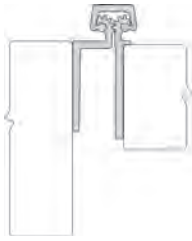

Description		Finish	2021 List	Stock No.	Case Qty.
780-113HD Concealed Leaf Heavy Duty "Safety Hinge" When Used Without Frame Stop	79" (2007 mm)	Clear	346.00	195097	6
		Dark Bronze	465.20	195098	
		Black	535.00	-	
	83" (2108 mm)	Clear	346.00	195099	6
		Dark Bronze	465.20	195100	
		Black	535.00	-	
	85" (2159 mm)	Clear	346.00	195101	6
		Dark Bronze	465.20	195102	
		Black	535.00	-	
	95" (2413 mm)	Clear	567.10	195103	6
		Dark Bronze	636.80	195104	
		Black	732.30	-	
	119" (3023 mm)	Clear	703.80	195105	4
		Dark Bronze	831.90	-	
		Black	956.70	-	

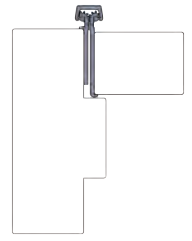

780-124HD Concealed Leaf Heavy Duty profile only Single Pack w/ Drill Quick Screws	79" (2007 mm)	Clear	173.70	194831	8
		Dark Bronze	226.20	194832	
		Black	260.20	-	
	83" (2108 mm)	Clear	173.70	183991	8
		Dark Bronze	226.20	194834	
		Black	260.20	140988	
	85" (2159 mm)	Clear	173.70	194835	8
		Dark Bronze	226.20	197391	
		Black	260.20	-	
	95" (2413 mm)	Clear	210.10	194836	7
		Dark Bronze	252.50	194837	
		Black	290.40	-	
	119" (3023 mm)	Clear	341.40	194838	7
		Dark Bronze	447.40	-	
		Black	514.50	-	

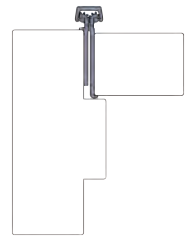

780-124LL Concealed Leaf Heavy Duty profile only With half drill quick and Half Wood Screws Lead Lined	79" (2007 mm)	Clear	195.90	55498	8
		Dark Bronze	252.50	-	
		Black	290.40	-	
	83" (2108 mm)	Clear	195.90	195114	8
		Dark Bronze	252.50	74529	
		Black	290.40	-	
	85" (2159 mm)	Clear	195.90	197934	8
		Dark Bronze	252.50	-	
		Black	290.40	-	
	95" (2413 mm)	Clear	235.30	75300	7
		Dark Bronze	296.90	-	
		Black	341.50	-	
	119" (3023 mm)	Clear	373.70	49286	7
		Dark Bronze	484.80	-	
		Black	557.50	-	



Roton Continuous Geared Hinges

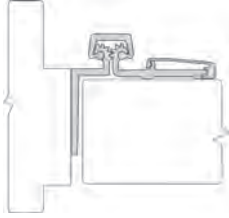

Description		Finish	2021 List	Stock No.	Case Qty.
780-155HD Half Surface Heavy Duty Center Hung and Egress Conversions	79" (2007 mm)	Clear	363.40	016603	5
		Dark Bronze	489.30	128736	
		Black	562.80	-	
	83" (2108 mm)	Clear	363.40	068088	5
		Dark Bronze	489.30	068371	
		Black	562.80	71061	
	85" (2159 mm)	Clear	363.40	018276	5
		Dark Bronze	489.30	046665	
		Black	562.80	-	
	95" (2413 mm)	Clear	445.90	063096	5
		Dark Bronze	603.30	056566	
		Black	693.80	196310	
	119" (3023 mm)	Clear	663.60	078745	2
		Dark Bronze	896.90	062632	
		Black	1,031.40	-	
780-157 Full Surface Frame Face Dimension Limitations	79" (2007 mm)	Clear	211.60	022092	5
		Dark Bronze	285.80	049196	
		Black	328.70	85841	
	83" (2108 mm)	Clear	211.60	048049	5
		Dark Bronze	285.80	063070	
		Black	328.70	159357	
	95" (2413 mm)	Clear	258.70	021262	5
		Dark Bronze	349.10	009045	
		Black	401.40	170884	



1. Items with the price in **bold and red** are Quick Ship items and ship in 24 hours.
Please use stock number when ordering. 2. U/M is each unless otherwise noted.



Roton Continuous Geared Hinges

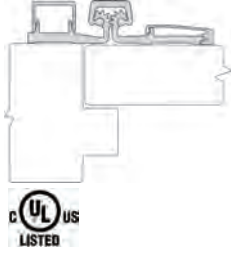

Description		Finish	2021 List	Stock No.	Case Qty.
780-157HD Full Surface Heavy Duty Frame Face Dimension Limitations	79" (2007 mm)	Clear	262.20	022028	5
		Dark Bronze	319.70	084386	
		Black	367.70	94867	
	83" (2108 mm)	Clear	262.20	048059	5
		Dark Bronze	319.70	062422	
		Black	367.70	36598	
	85" (2159 mm)	Clear	262.20	019546	5
		Dark Bronze	319.70	035156	
		Black	367.70	188600	
	95" (2413 mm)	Clear	314.60	048060	5
		Dark Bronze	384.10	010547	
		Black	441.70	112593	
	119" (3023 mm)	Clear	521.40	099644	2
		Dark Bronze	678.80	037141	
		Black	780.60	189834	
780-210 Full Surface	79" (2007 mm)	Clear	211.60	010064	6
		Dark Bronze	285.80	073030	
		Black	328.70	60919	
	83" (2108 mm)	Clear	211.60	048050	6
		Dark Bronze	285.80	048051	
		Black	328.70	45510	
	95" (2413 mm)	Clear	253.20	063037	6
		Dark Bronze	344.90	020588	
		Black	396.60	068541	

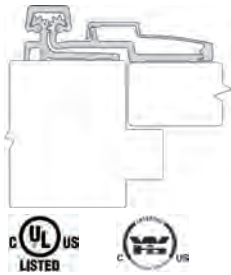

1. Items with the price in **bold and red** are Quick Ship items and ship in 24 hours. Please use stock number when ordering. 2. U/M is each unless otherwise noted.

Roton Continuous Geared Hinges

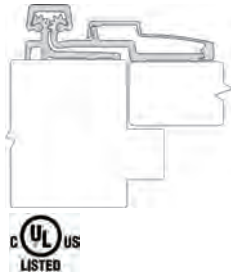

Description	Finish	2021 List	Stock No.	Case Qty.	
780-210HD Full Surface Heavy Duty	79" (2007 mm)	Clear	258.20	017046	6
		Dark Bronze	313.90	017037	
		Black	361.00	177093	
	83" (2108 mm)	Clear	258.20	048061	6
		Dark Bronze	313.90	048062	
		Black	361.00	93405	
	85" (2159 mm)	Clear	258.20	024124	6
		Dark Bronze	313.90	071974	
		Black	361.00	-	
95" (2413 mm)	Clear	304.80	048063	6	
	Dark Bronze	375.00	046722		
	Black	431.20	154984		
119" (3023 mm)	Clear	509.80	025722	2	
	Dark Bronze	571.40	000304		
	Black	657.10	165971		



780-211HD Half Surface Heavy Duty Frame Leaf Wrap-Around Reinforcement for Damaged Frames	79" (2007 mm)	Clear	508.20	195201	4
		Dark Bronze	667.70	198388	
		Black	767.90	-	
	83" (2108 mm)	Clear	508.20	195202	4
		Dark Bronze	667.70	195203	
		Black	767.90	-	
	85" (2159 mm)	Clear	508.20	195204	4
		Dark Bronze	667.70	195205	
		Black	767.90	-	
	95" (2413 mm)	Clear	625.40	195207	4
		Dark Bronze	821.80	146310	
		Black	945.10	-	
119" (3023 mm)	Clear	931.70	195208	2	
	Dark Bronze	1,224.60	53808		
	Black	1,408.30	-		

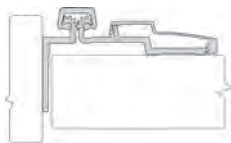

780-213HD Half Surface Heavy Duty Center Hung Doors	79" (2007 mm)	Clear	481.30	195209	4
		Dark Bronze	635.50	195210	
		Black	730.80	-	
	83" (2108 mm)	Clear	481.30	195211	4
		Dark Bronze	635.50	195212	
		Black	730.80	-	
	85" (2159 mm)	Clear	481.30	195213	4
		Dark Bronze	635.50	195216	
		Black	730.80	-	
	95" (2413 mm)	Clear	590.60	195217	4
		Dark Bronze	781.60	195218	
		Black	898.80	-	
119" (3023 mm)	Clear	880.10	195219	2	
	Dark Bronze	1,164.90	195220		
	Black	1,339.60	-		

1. Items with the price in **bold and red** are Quick Ship items and ship in 24 hours.
Please use stock number when ordering. 2. U/M is each unless otherwise noted.



Roton Continuous Geared Hinges

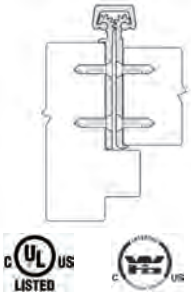

Description		Finish	2021 List	Stock No.	Case Qty.
780-224 Concealed Leaf 1-3/4" Doors Single Pack w/ Drill Quick Screws	79" (2007 mm)	Clear	139.30	183923	7
		Dark Bronze	181.70	194839	
		Black	209.00	-	
	83" (2108 mm)	Clear	139.30	184005	7
		Dark Bronze	181.70	184006	
		Black	209.00	90379	
	95" (2413 mm)	Clear	176.60	184036	7
		Dark Bronze	228.30	194840	
		Black	262.50	198251	

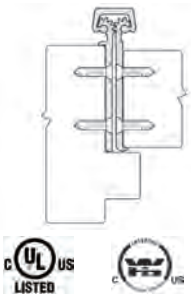

780-224 Bulk Pack Concealed Leaf 1-3/4" Doors Case Pack w/ Drill Quick Screws Must Order Case Quantity	83" (2108 mm)	Clear	125.30	194841	7
---	---------------	-------	--------	--------	---

780-224HD Concealed Leaf 1-3/4" Doors Single Pack w/ Drill Quick Screws	79" (2007 mm)	Clear	173.80	183882	7
		Dark Bronze	226.00	183921	
		Black	259.90	67150	
	83" (2108 mm)	Clear	173.80	184122	7
		Dark Bronze	226.00	183973	
		Black	259.90	183992	
	85" (2159 mm)	Clear	173.80	184012	7
		Dark Bronze	226.00	184014	
		Black	259.90	199457	
	95" (2413 mm)	Clear	210.50	184022	7
		Dark Bronze	277.20	184023	
		Black	318.80	195809	
	119" (3023 mm)	Clear	344.90	184039	5
		Dark Bronze	449.00	194842	
		Black	516.40	195810	

780-224HD Concealed Leaf 1-3/4" Doors Case Pack w/ Drill Quick Screws Must Order Case Quantity	83" (2108 mm)	Clear	156.40	194828	7
		Dark Bronze	203.50	194829	
		Black	234.00	90247	

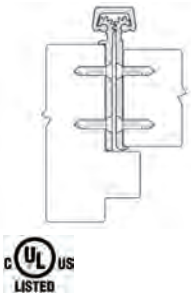

780-224LL Concealed Leaf 1-3/4" Doors Lead Lined With Half Drill Quick and Half Wood Screws Heavy Duty Profile Only	79" (2007 mm)	Clear	200.70	195181	7
		Dark Bronze	256.10	195221	
		Black	294.60		
	83" (2108 mm)	Clear	200.70	195184	7
		Dark Bronze	256.10	195222	
		Black	294.60	53872	
	85" (2159 mm)	Clear	200.70	195223	7
		Dark Bronze	256.10	-	
		Black	294.60	-	
	95" (2413 mm)	Clear	242.70	195224	7
		Dark Bronze	298.80	195225	
		Black	343.60	-	
	119" (3023 mm)	Clear	381.70	195226	5
		Dark Bronze	492.00	-	
		Black	565.80	-	



Roton Continuous Geared Hinges



Description	Size	Finish	2021 List	Stock No.	Case Qty.	
780-226HD Concealed Leaf Heavy Duty For Doors 2" or Thicker	79" (2007 mm)	Clear	207.90	194843	7	
		Dark Bronze	274.20	194844		
		Black	315.40	-		
	Concealed Leaf Heavy Duty For Doors 2" or Thicker	83" (2108 mm)	Clear	207.90	183974	7
			Dark Bronze	274.20	194845	
			Black	315.40	195812	
	85" (2159 mm)	Clear	207.90	194846	7	
		Dark Bronze	274.20	194849		
		Black	315.40	67532		
95" (2413 mm)	Clear	253.00	184024	7		
	Dark Bronze	325.30	194850			
	Black	374.10	195813			
119" (3023 mm)	Clear	410.90	193587	5		
	Dark Bronze	533.70	194851			
	Black	613.70	195815			



780-226LL Concealed Leaf For Lead Lined Doors 2" or Thicker With Half Drill Quick and Half Wood Screws Heavy Duty Profile Only	79" (2007 mm)	Clear	225.30	195229	7
		Dark Bronze	287.00	195233	
		Black	330.00	-	
	83" (2108 mm)	Clear	225.30	195235	7
		Dark Bronze	287.00	95797	
		Black	330.00	-	
	85" (2159 mm)	Clear	225.30	143304	7
		Dark Bronze	287.00	-	
		Black	330.00	-	
	95" (2413 mm)	Clear	272.30	195236	7
		Dark Bronze	327.20	195237	
		Black	376.30	-	
119" (3023 mm)	Clear	427.70	195238	5	
	Dark Bronze	551.00	195239		
	Black	633.70	-		

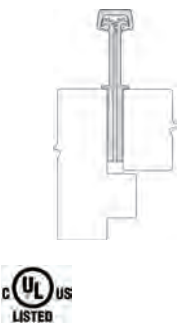

780-235HD Concealed Leaf Heavy Duty Wide Throw	83" (2108 mm)	Clear	483.40	125582	1
		Dark Bronze	632.80	141654	
		Black	727.70	198301	
	95" (2413 mm)	Clear	596.60	129916	1
		Dark Bronze	760.10	199537	
		Black	874.10	198678	

1. Items with the price in **bold and red** are Quick Ship items and ship in 24 hours.
Please use stock number when ordering. 2. U/M is each unless otherwise noted.



Roton Continuous Geared Hinges



Description	Size	Finish	2021 List	Stock No.	Case Qty.
780-257HD Full Surface Heavy Duty Double hinge for hanging two doors from a fixed mullion.	79" (2007 mm)	Clear	505.50	-	2
		Dark Bronze	694.50	-	
		Black	798.60	-	
	83" (2108 mm)	Clear	505.50	081899	2
		Dark Bronze	694.50	159250	
		Black	798.60	189136	
	85" (2159 mm)	Clear	505.50	112767	2
		Dark Bronze	694.50	158749	
		Black	798.60	-	
	95" (2413 mm)	Clear	622.10	028146	2
		Dark Bronze	854.00	161153	
		Black	982.10	-	
	119" (3023 mm)	Clear	927.60	162543	2
		Dark Bronze	1,272.90	179221	
		Black	1,463.80	-	
780-300HD Half Surface Heavy Duty Center Hung Applications	79" (2007 mm)	Clear	360.80	010212	4
		Dark Bronze	490.10	019206	
		Black	563.10	-	
	83" (2108 mm)	Clear	360.80	047819	4
		Dark Bronze	490.10	057968	
		Black	563.10	22490	
	85" (2159 mm)	Clear	360.80	061937	4
		Dark Bronze	490.10	038063	
		Black	563.10	-	
	95" (2413 mm)	Clear	443.80	047821	4
		Dark Bronze	602.10	047822	
		Black	692.40	83347	
	119" (3023 mm)	Clear	661.00	015052	2
		Dark Bronze	898.20	011244	1/1/2021
		Black	1,033.00	92138	

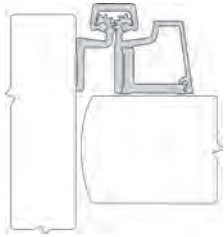

Roton Continuous Geared Hinges

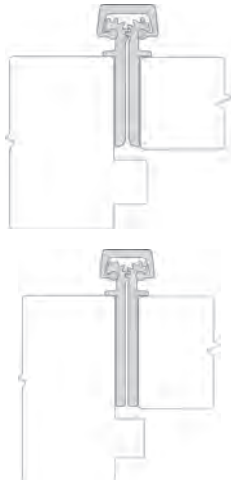

Description	Size	Finish	2021 List	Stock No.	Case Qty.
1200-600XHD Concealed Leaf Extra Heavy Duty For doors from 1-3/4" to 2-3/8" thick.	83" (2108 mm)	Clear	1,047.00	000590	1
		Dark Bronze	1,465.00	028601	
	95" (2413 mm)	Clear	1,186.25	004040	1
		Dark Bronze	1,605.00	065709	
	119" (3023 mm)	Clear	1,326.00	090770	1
		Dark Bronze	1,744.00	107206	
1200-650XHD Concealed Leaf Extra Heavy Duty For doors 2-3/8" thick or thicker.	83" (2108 mm)	Clear	1,396.00	090353	1
		Dark Bronze	1,814.00	135473	
	95" (2413 mm)	Clear	1,535.00	090439	1
		Dark Bronze	1,954.00	108903	
	119" (3023 mm)	Clear	1,675.00	090440	1
		Dark Bronze	2,093.00	044852	

1. Items with the price in **bold and red** are Quick Ship items and ship in 24 hours.
Please use stock number when ordering. 2. U/M is each unless otherwise noted.

