



IVES

Price Book 9

Effective April 3, 2021 • Rev 04/21



This price list supersedes and cancels all previous price lists. Prices shown are subject to change without notice.

Administrative Offices

Allegion Administrative Office
11819 N. Pennsylvania St.
Carmel, IN 46032
allegion.com/us

Placing orders

You can place orders with Allegion via the fax number or email listed below:

Fax#: 1-877-424-8494
Email: Allegion_Orders@allegion.com

Customer Care

Our Customer Care Representatives are available for questions or assistance.
You can reach them at **877-671-7011** (Press 1 for Sales Support | Press 2 for Product Support | Press 3 for RSO) or through the email addresses listed below:

Sales Support

support@allegion.com

Technical Product Support

Hinges, O/H Stops, Accessories

Accessories_TechProdSupport@allegion.com

Request for Quote

Carolinas

(North Carolina, South Carolina, Virginia)
Carolinas.Quotes@allegion.com

Central

(Arkansas, Illinois, Iowa, Kansas, Missouri, Nebraska, Oklahoma)
Central.Quotes@allegion.com

Chicago

(Illinois-Northern, Wisconsin)
Chicago.Quotes@allegion.com

Florida

Florida.Quotes@allegion.com

Great Lakes

(New York, Pennsylvania)
GreatLakes.Quotes@allegion.com

Metro New York

Metro.Quotes@allegion.com

Michigan

Michigan.Quotes@allegion.com

Mid Atlantic North

(New York, Pennsylvania)
Mid.Atlantics.north.quotes@allegion.com

Mid Atlantic South

(Delaware, Maryland, New Jersey)
Mid.Atlantics.south.quotes@allegion.com

Midwest

(Indiana, Kentucky, Ohio, West Virginia)
Midwest.Quotes@allegion.com

Mountain States

(Colorado, Idaho, Montana, Nevada, Utah, Wyoming)
Mtn.States.Quotes@allegion.com

New England

(Connecticut, Main, Massachusetts, New Hampshire, Rhode Island, Vermont)
NewEngland.Quotes@allegion.com

North Central

(Minnesota, North Dakota, South Dakota)
NorthCentral.Quotes@allegion.com

Northern California

NoCal.Quotes@allegion.com

Northwest

(Alaska, Oregon, Washington)
Northwest.Quotes@allegion.com

South

(Alabama, Georgia, Louisiana, Mississippi, Tennessee)
South.Quotes@allegion.com

Southern California

(California-Southern, Hawaii)
SoCal.Quotes@allegion.com

Southwest

(Arizona, New Mexico)
Southwest.Quotes@allegion.com

Texas

Texas.Quotes@allegion.com

How to use this book ii
Index by Product Number..... iii
Keys to Finishes iv-v
Architectural (Butt) Hinges..... 1-15
Continuous Hinge..... 16-23
Pivots24-26
Edge Guard..... 27-30
Architectural Hardware..... 31-92
Service Parts 93-136

Policies and documents

The purchase of Allegion products is governed by the Allegion Authorized Seller Program. For program terms and conditions, and other program details, please visit: www.allegion.com/AuthorizedSeller.

For Warranty information, visit us.allegion.com/warranty or contact Customer Service at 877-671-7011.

BAA/ARRA

For a list of available BAA/ARRA compliant products please contact your local RSO or Customer Care at 877-671-7011

How to use this book

Products are shown in four groups; Hinges, Continuous Hinges, Pivots and Architectural Hardware. Each group is organized in numerical order and no longer in alpha/numerical. Particularly in the Architectural Hardware group, the products are organized by the part number regardless of the prefix or suffix. Example WS33X Wall Stop will be in numerical sequence of 33; CS115 Crash Stop numerical sequence 115.

For convenience there are a few exceptions where an accessory follows the associated product; example, the COR72 Coordinator is followed by MBI Mounting Bracket.

Service parts section follows the finished goods. Service parts are listed in a similar order to their finished goods counterparts.

Information contained in the list price table:

Model: Column contains model family description and general catalog information

Substrate: Column contains material substrate information (i.e. aluminum, brass, steel)

Model Number: Column contains the model number and additional prefix for other distinguishing features or packaging type. Package type prefix (SP) descriptions are as follows:

SP – Slim Pack

Item Number: Item number field is UPC number or sku number, where available.

Weight: Contains the total weight of product in box quantity. Not all weights shown.

Order Quantity: Contains the minimum order quantity for identified product, if required.

Box Quantity: Number of items in master carton or special package type.

Markings Cartons: Markings (e.g., door locations, stock reference numbers) on individual product cartons will be provided with no charge.

Products available to mark include the following:

Architectural Hinges	Push/Pull Plates
Continuous Hinges	Protection Plates
Pivots	Coordinators
8000 Series Pulls	Flush Bolts
9000 Series Push bars/Pull combinations	Vandal Resistant Trim

Lead Times: Ives Quick Ship stocked offering includes over 600 items that will be shipped in 3 business days or less. All stocked items are noted on the line item notes or with a "***" denotation. For more information and to view a list of our full offering here: us.allegion.com/ivesquickship.

Made to order products will have a standard lead time of 2-3 weeks unless otherwise noted. See product pages for specific exceptions. Purchase orders that combine made to order and stocked items will be held and shipped together.

Numerical Index

Part No.	Page	Part No.	Page	Part No.	Page	Part No.	Page	Part No.	Page
hinges									
3PB1.....	1, 2	7306.....	28	40.....	37, 38	406/407CVX.....	50	VR904.....	61
3CB1.....	3, 4	7306B.....	28	FS40.....	38	406/407CCV.....	50	VR900LLP.....	61
3CB1 HW.....	5	7307.....	28	WS40.....	38	FS410.....	51	VR904LLP.....	61
3CB1 WT.....	6, 7	7308.....	28	FB41.....	38	411.....	51	VR910DT.....	61
3SP1.....	7	7309.....	28	FS41.....	38	430.....	51	VR914DT.....	61
5PB1.....	8, 9	7310.....	28	42.....	38	FS434.....	51	VR910NL.....	61
5BB1.....	9, 10	7310B.....	28	COR42.....	38	R435.....	51	VR914NL.....	61
5BB1 HW.....	11	7311.....	29	FB42.....	39	FS436.....	51	VR910M-DT.....	61
5BB1 SC.....	12	7310S.....	29	FS42.....	39	R437.....	51	VR910M-NL.....	61
5BB1 HW SC.....	12	7310SB.....	29	FS43.....	39	FS438.....	52	919.....	61
5BB1 WT.....	13, 14	7302-A.....	29	FL44.....	39	FS439.....	52	950.....	61
1010*.....	15	7302B-A.....	29	WS45.....	39	FS441.....	52	955.....	62
1011*.....	15	7306-A.....	29	WS45X.....	39	WS443.....	52	960.....	62
1012*.....	15	7306B-A.....	29	S48.....	39	FS444.....	52	962.....	62
1020*.....	15	architectural hardware							
1021*.....	15	CB1.....	31	COR52.....	39	WS445.....	52	990.....	62
continuous hinges									
600.....	16	DP1.....	31	FB52.....	40	FS446.....	52	991.....	62
602.....	16	DP2.....	31	FB53.....	40	WS447.....	53	RL1152.....	63
611.....	16	2.....	31	054.....	40	FS448.....	53	FS1153.....	63
700.....	16	LG7.....	31	059.....	40	WS449.....	53	FS1154.....	63
702.....	16	COR7G.....	31	59.....	40	FS450.....	53	SB1600M1.....	63
705.....	16	07.....	32	060.....	41	FS452.....	53	SB1600M2.....	63
711.....	16	COR9G.....	32	60.....	41	SB453.....	53, 54	SB1630.....	64
715.....	16	FS9.....	32	COR60.....	41	FS455.....	54	SB1640.....	64
700CS.....	18	LG10.....	32	061.....	42	FB457.....	54	3125.....	65
711CS.....	18	CL11.....	32	61.....	42, 43	FB458.....	54	31251.....	65
715CS.....	18	LG11.....	32	FB61.....	43	RB470.....	54	31252.....	65
026XY.....	19	WS11.....	32	FB62.....	43	RB471.....	54	8102HD.....	69
027XY.....	19	CL12.....	33	63.....	43	RB472.....	54	8103HD.....	69, 70
040XY.....	19	LG12.....	33	64.....	43	481.....	55	8103EZHD.....	70
041XY.....	19	FS13.....	33	SR64.....	43	482.....	55	8105.....	71
045XY.....	19	LG13.....	33	WS65.....	43	482 s.....	55	8111.....	71
046XY.....	19	CL14.....	33	SR65.....	43	FS495.....	55	8112.....	71
053XY.....	20	LG14.....	33	SR66.....	43	FS496.....	55	8121.....	72
054XY.....	20	FS17.....	33	066.....	44	FS497.....	55	8145EZHD.....	72
112HD.....	20	R14.....	33	66.....	44	FS544.....	55	8169.....	72
112XY.....	20	AS18.....	33	69.....	44	FS555.....	55	8181.....	73
114XY.....	20	FS18.....	33	70.....	44, 45	506.....	56	8189.....	73
157XY.....	20	FL20.....	33	71.....	45	507.....	56	8190HD.....	73
210XY.....	21	WS20.....	33	72.....	45	507B.....	56	8190EZHD.....	74
224HD.....	21	WS20X.....	34	COR72.....	45	508.....	56	8200.....	75
224XY.....	21	CL21/21A.....	34	73.....	45	508C.....	56	8281.....	76
pivots									
7212.....	24	CL22.....	34	90.....	45	509C.....	56	8302.....	76, 77
7212V.....	24	22.....	34	FP100.....	45	510C.....	56	8303.....	78, 79
7215.....	24	25.....	34	AP101.....	45	510BC.....	56	8305.....	79, 80
7215F.....	24	O26.....	34, 35	CS115.....	45	511BC.....	56	8312.....	81
7222.....	24	RL30.....	35	HB159.....	45	543.....	56	8320.....	81
7226.....	24	RL30A.....	35	218*.....	46	543B.....	56	8311.....	81
7226F.....	25	FB31.....	35	221.....	46	554.....	56	8371.....	82
7227.....	25	COR32*.....	35	222.....	46	559B.....	57	8372.....	82
7227F.....	25	COR42*.....	35	223.....	46	571.....	57	8400.....	83
7230F.....	25	COR52*.....	36	227.....	46	572.....	57	8700.....	86
7237F.....	25	COR60*.....	36	230.....	46	574.....	58	8800.....	86
7244F.....	25	COR72*.....	36	253.....	47	575.....	58	8848.....	86
7245F.....	26	FL20.....	36	261.....	47	580.....	58	8975.....	86
7253.....	26	FL32.....	36	262.....	47	581.....	58, 59	9100HD.....	87
7255.....	26	FL44.....	36	265.....	47	582.....	59	9103EZHD.....	87
7255J.....	26	MB1.....	36	299.....	47, 48	585/586.....	59	9145EZHD.....	88
7256.....	26	MB1F & MB1V.....	36	OT300.....	48	601.....	59	9190HD.....	89
7256.....	26	MB2.....	36	OTP300.....	48	620.....	59	9190EZHD.....	90
7259.....	26	MB2F & MB2V.....	36	325.....	48	620.....	60	9264.....	91
91105F.....	26	MB3F & MB3V.....	36	326.....	48	620.....	60	9264F.....	91
edge guards									
7300.....	27	FB32.....	37	327.....	48	620.....	60	9264F.....	91
7301.....	27	COR32.....	37	330.....	48	696-700-701.....	60	9266.....	91
7302.....	27	FL32.....	37	335.....	48	698.....	60	9266F.....	91
7302B.....	27	RL32.....	37	336.....	48	700.....	60		
7303.....	27	RL32A.....	37	345.....	49	701.....	60		
7304.....	27	FB33.....	37	347.....	49	VR810DT.....	61		
7305.....	27	WS33.....	37	349.....	49	VR814DT.....	61		
		WS33X.....	37	FB358.....	49	VR810NL.....	61		
		RL36/36A.....	37	SB360.....	49	VR814NL.....	61		
		RL38.....	37	401/402CVX.....	49	VR810NL-V.....	61		
				401/402CCV.....	49	VR814NL-V.....	61		
				WS404-CVX.....	50	AS895.....	61		
				405.....	50	VR900.....	61		

Key to Finishes

IVES FINISH	ANSI/BHMA	US Number	Finish Description	Base Material
A3	666	US3	Bright Brass, Clear Coat	Aluminum
A4	667	US4	Satin Brass, Clear Coat	Aluminum
A5		US5	Brass, Blackened, Satin Relieved	Aluminum
A10	668	US10	Satin Bronze, Clear Coat	Aluminum
A10B	703	US10B	Dark Bronze, Oil Rubbed	Aluminum
A14	669	US14	Bright Nickel, Clear Coat	Aluminum
A15	670	US15	Satin Nickel, clear Coat	Aluminum
A26	672	US26	Bright Chrome	Aluminum
A26D	702	US26D	Satin Chrome	Aluminum
A-643E/716			Aged Bronze, Blackened, Edge Relieved	Aluminum
A92	673		Aluminum Clear Coat	Aluminum
A-BLK			Matte Black	Aluminum
A-W			White	Aluminum
	627	US27	Satin Aluminum, Clear Coated	Aluminum
	441		Satin Stainless Anodized	Aluminum
PA28	628	US28	Satin Aluminum, Clear Anodized	Aluminum
	688		Satin Brass Anodized	Aluminum
	709		Satin Bronze Anodized	Aluminum
	710	313AN	Dark Bronze Anodized	Aluminum
	711	315AN	Black Anodized	Aluminum
	712		Bright Chrome Anodized	Aluminum
	713		Satin Chrome Anodized	Aluminum
B3	605	US3	Bright Brass, Clear Coat	Brass/Bronze
B4	606	US4	Satin Brass, Clear Coat	Brass/Bronze
B5	609	US5	Satin Brass, Blackened, Satin Relieved	Brass/Bronze
B9	611	US9	Bright Bronze, Clear Coat	Brass/Bronze
B10	612	US10	Satin Bronze, Clear Coat	Brass/Bronze
B10B	613	US10B	Dark Bronze, Oil Rubbed	Brass/Bronze
	614	US10A	Satin Bronze, Relieved, Clear Coated	Brass/Bronze
	616	US11	Satin Bronze, Blackened, Clear Coated	Brass/Bronze
B14	618	US14	Bright Nickel, Clear Coat	Brass/Bronze
B15	619	US15	Satin Nickel, Clear Coat	Brass/Bronze
B15A	620	US15A	Satin Nickel, Blackened, Satin Relieved	Brass/Bronze
B26	625	US26	Bright Chrome	Brass/Bronze
B26D	626	US26D	Satin Chrome	Brass/Bronze
B-643E/716		US19	Aged Bronze, Blackened, Edge Relieved	Brass/Bronze
B-BLK	622		Matte Black	Brass/Bronze
	603	US2G	Zinc Plated	Steel
F2C	604	US2C	Zinc Plated	Steel
F3	632	US3	Bright Brass, Clear Coat	Steel
F4	633	US4	Satin Brass, Clear Coat	Steel
F5	638	US5	Satin Brass, Blackened, Satin Relieved	Steel
F10	639	US10	Satin Bronze, Clear Coat	Steel
F10B	640	US10B	Dark Bronze, Oil Rubbed	Steel
	641	US10A	Oxidized Satin Bronze, Relieved, Clear Coated	Steel
	643	US11	Satin Bronze, Blackened, Relieved, Clear Coated	Steel
F14	645	US14	Bright Nickel, Clear Coat	Steel
F15	646	US15	Satin Nickel, Clear Coated	Steel
F15A	647	US15A	Satin Nickel, Blackened, Relieved, Clear Coated	Steel
F26	651	US26	Bright Chrome	Steel
F26D	652	US26D	Satin Chrome	Steel
F-643E/716		US19	Aged Bronze, Blackened, Edge Relieved	Steel
F-BLK	631		Matte Black	Steel
F-W			White	Steel
SP4			Dull Brass Painted	All
SP10	691		Dull Bronze Painted	All

Key to Finishes

IVES FINISH	ANSI/BHMA	US Number	Finish Description	Base Material
SP28	689		Aluminum Painted	All
SP313	695		Dark Bronze Painted	All
SPBLK	622		Matte Black	All
USP	600	USP	Primed For Paint	All
US32	629	US32	Bright Stainless Steel	Stainless Steel
US32-316	629-316	US32-316	Bright Stainless Steel - 316 Series	Stainless Steel - 316
US32D	630	US32D	Satin Stainless Steel	Stainless Steel
US32D-316	630-316	US32D-316	Satin Stainless Steel - 316 Series	Stainless Steel - 316
US32D	654		Satin Stainless Steel	Stainless Steel
Z605	677	US3	Bright Brass, Clear Coat	Zinc
	678	US4	Satin Brass, Clear Coat	Zinc
Z609		US5	Satin Brass, Blackened, Satin Relieved	Zinc
Z613	704	US10B	Dark Bronze, Oil Rubbed	Zinc
Z619		US15	Satin Nickel, Clear Coat	Zinc
Z625	681	US26	Bright Chrome	Zinc
	682	US26D	Satin Chrome	Zinc
Z-643E/716			Aged Bronze, Blackened, Edge Relieved	Zinc
Z-BLK	676		Matte Black	Zinc
Z-W			White	Zinc
CLR			Clear	Plastic
BLK			Matte Black	Rubber or Plastic
WHT			White	Rubber or Plastic
GRY			Grey	Rubber
TAN			Tan	Rubber
BRN			Brown	Rubber

Custom Finishes

Optional powder coat finishes are available on many Ives products. To have a specific color matched and to determine powder coat availability please contact:

TIGER Drylac U.S.A., Inc.
3945 Swenson Ave
St. Charles, IL 60174
800-243-8148
www.tiger-coatings.us

Powder coat must be selected from Tiger Drylac **Series 38 or 49**.

Please specify **both** the full powder coat product number and the RAL number when placing your order.

Example: 49/15320 RAL 1015

DESCRIPTION	SIZE	STEEL BASED		BRASS / STAINLESS BASED		US REFERENCE	BOX	CASE	NOTES
		BHMA FINISH	LIST	BHMA FINISH	LIST				
 <p>Three Knuckle Plain Bearing Standard Weight</p> <p>For use on standard weight doors with medium frequency usage</p> <p>Available in: Steel w/Steel Pin Brass w/Brass Pin Stainless w/Stainless Pin</p> <p>Non-removable Pin (Steel and Stainless Steel Based 4.5 x 4.5 Hinges add \$4.75 all others add \$9.50 list)</p> <p>Packed with: Wood and machine screws</p> <p>Available options: SEC - Security Screws HT - Hospital tip RC - Round corners SH - Security Studs See page 14 for pricing</p>	3.5"x3.5" (89x89mm)	600	\$13.10	----	\$ ----	USP	3	24	
		632	19.10	605	67.00	US3	3	24	
		633	13.70	606	55.70	US4	3	24	
		639	14.60	612	52.00	US10	3	24	
		640	19.10	613	67.00	US10B	3	24	
		641	19.10	614	67.00	US10A	3	24	
		643	20.30	616	67.00	US11	3	24	
		F643E/716	20.30	B643E/716	67.00	US11E	3	24	
		646	20.30	619	67.00	US15	3	24	
		651	19.10	625	70.70	US26	3	24	
		652	16.10	626	63.20	US26D	3	24	
		F-BLK	14.60	B-BLK	52.00	US19	3	24	
		----	----	629	76.40	US32	3	24	
		----	----	630	73.50	US32D	3	24	
		4"x4" (102x102mm)	600	14.50	----	----	USP	3	24
	632		21.30	605	75.30	US3	3	24	
	633		15.10	606	62.60	US4	3	24	
	639		16.10	612	58.60	US10	3	24	
	640		21.30	613	75.40	US10B	3	24	
	641		21.30	614	75.40	US10A	3	24	
	643		22.40	616	75.40	US11	3	24	
	F643E/716		22.40	B643E/716	67.00	US11E	3	24	
	646		22.40	619	75.40	US15	3	24	
	651		21.30	625	79.50	US26	3	24	
	652		18.00	626	71.10	US26D	3	24	
	F-BLK		16.10	B-BLK	58.60	US19	3	24	
	----		----	629	86.20	US32	3	24	
	----		----	630	82.80	US32D	3	24	
	4.5"x4" (114x102mm)		600	7.80	----	----	USP	3	24
		632	15.30	605	43.50	US3	3	24	
		633	7.80	606	36.30	US4	3	24	
		639	9.50	612	33.80	US10	3	24	
		640	13.80	613	43.50	US10B	3	24	
		641	14.80	614	43.50	US10A	3	24	
		643	15.30	616	43.50	US11	3	24	
		F643E/716	15.30	B643E/716	43.50	US11E	3	24	
		646	15.30	619	43.50	US15	3	24	
		651	15.30	625	45.90	US26	3	24	
		652	11.60	626	41.00	US26D	3	24	
		F-BLK	9.50	B-BLK	33.80	US19	3	24	
		----	----	629	49.60	US32	3	24	
		----	----	630	48.30	US32D	3	24	
		4.5"x4.5" (114x114mm)	600	7.80	----	----	USP	3	24
	632		15.30	605	43.50	US3	3	24	
	633		7.80	606	36.30	US4	3	24	
639	9.50		612	33.80	US10	3	24		
640	15.30		613	43.50	US10B	3	24		
641	15.30		614	43.50	US10A	3	24		
643	15.30		616	43.50	US11	3	24		
F643E/716	15.30		B643E/716	43.50	US11E	3	24		
646	15.30		619	43.50	US15	3	24		
651	15.30		625	45.90	US26	3	24		
652	8.80		626	41.00	US26D	3	24		
F-BLK	9.50		B-BLK	33.80	US19	3	24		
----	----		629	49.60	US32	3	24		
----	----		630	48.30	US32D	3	24		

Note: Specify BHMA finish code when ordering.

 Indicates products that have EPD documentation available and meet LEED v4.

Contact Ives Customer Service for pricing on additional sizes and finishes

Bold pricing indicates item is in stock and available for **Fast Track** and **ProXpress**

HINGES
CONTINUOUS HINGES
PIVOTS
Numerical 1-059
Numerical 59-437
Numerical 438-1021
Numerical 1152-8190
Numerical 8200-9266

DESCRIPTION	SIZE	STEEL BASED		BRASS / STAINLESS BASED		US REFERENCE	BOX	CASE	NOTES
		BHMA FINISH	LIST	BHMA FINISH	LIST				
 <p>3PB1</p> <p>Three Knuckle Plain Bearing Standard Weight</p> <p>For use on standard weight doors with medium frequency usage</p>	5"x4.5" (127x114mm)	600	\$37.10	----	\$ ----	USP	3	24	
		632	55.60	605	101.90	US3	3	24	
		633	39.40	606	84.80	US4	3	24	
		639	41.60	612	79.00	US10	3	24	
		640	55.60	613	101.90	US10B	3	24	
		641	55.60	614	101.90	US10A	3	24	
		643	57.70	616	101.90	US11	3	24	
		F643E/716	57.70	B643E/716	101.90	US11E	3	24	
		646	57.70	619	101.90	US15	3	24	
		651	55.60	625	107.30	US26	3	24	
		652	46.30	626	96.20	US26D	3	24	
		F-BLK	41.60	B-BLK	79.00	US19	3	24	
		----	----	629	116.50	US32	3	24	
		----	----	630	111.90	US32D	3	24	

Note: Specify BHMA finish code when ordering.

 Indicates products that have EPD documentation available and meet LEED v4.

Contact Ives Customer Service for pricing on additional sizes and finishes

Bold pricing indicates item is in stock and available for **Fast Track** and **ProXpress**

DESCRIPTION	SIZE	STEEL BASED		BRASS / STAINLESS BASED		US REFERENCE	BOX	CASE	NOTES
		BHMA FINISH	LIST	BHMA FINISH	LIST				
 <p>Three Knuckle Concealed Bearing Standard Weight</p> <p>For use on standard weight doors with medium frequency usage</p> <p>Available in: Steel w/Steel Pin Brass w/Brass Pin Stainless w/Stainless Pin</p> <p>Non-removable Pin (Steel and Stainless Steel Based 4.5 x 4.5 Hinges add \$4.75 all others add \$9.50 list)</p> <p>Packed with: Wood and machine screws</p> <p>Available options: SEC - Security Screws HT - Hospital tip RC - Round corners SH - Security Studs</p> <p>TW - Electric Thru Wire See page 14 for pricing and available sizes</p>	3.5"x3.5" (89x89mm)	600	\$29.80	----	\$ ----	USP	3	24	
		632	45.40	605	65.60	US3	3	24	
		633	32.10	606	54.50	US4	3	24	
		639	34.10	612	50.90	US10	3	24	
		640	45.40	613	65.60	US10B	3	24	
		641	45.40	614	65.60	US10A	3	24	
		643	47.30	616	65.60	US11	3	24	
		F643E/716	47.30	B643E/716	65.60	US11E	3	24	
		646	47.30	619	65.60	US15	3	24	
		651	45.40	625	69.30	US26	3	24	
		652	38.00	626	62.00	US26D	3	24	
		F-BLK	34.10	B-BLK	50.90	US19	3	24	
		----	----	629	75.10	US32	3	24	
		----	----	630	72.10	US32D	3	24	
		4"x4" (102x102mm)	600	32.30	----	----	USP	3	24
	632		48.80	605	73.90	US3	3	24	
	633		34.40	606	61.50	US4	3	24	
	639		36.60	612	57.50	US10	3	24	
	640		48.80	613	73.90	US10B	3	24	
	641		48.80	614	73.90	US10A	3	24	
	643		50.80	616	73.90	US11	3	24	
	F643E/716		50.80	B643E/716	73.90	US11E	3	24	
	646		50.80	619	73.90	US15	3	24	
	651		48.80	625	78.10	US26	3	24	
	652		40.70	626	69.90	US26D	3	24	
	F-BLK		36.60	B-BLK	57.50	US19	3	24	
	----		----	629	84.70	US32	3	24	
	----		----	630	81.30	US32D	3	24	
	4.5"x4" (114x102mm)		600	18.30	----	----	USP	3	24
		632	25.70	605	65.00	US3	3	24	
		633	18.30	606	54.10	US4	3	24	
		639	20.00	612	50.60	US10	3	24	
		640	18.30	613	65.00	US10B	3	24	
		641	18.30	614	65.00	US10A	3	24	
		643	25.70	616	65.00	US11	3	24	
		F643E/716	25.70	B643E/716	65.00	US11E	3	24	
		646	28.50	619	65.00	US15	3	24	
		651	25.70	625	68.80	US26	3	24	
		652	21.60	626	61.30	US26D	3	24	652 finish Stocked, 652 NRP Stocked
		F-BLK	20.00	B-BLK	50.60	US19	3	24	
		----	----	629	74.60	US32	3	24	
		----	----	630	66.10	US32D	3	24	
		4.5"x4.5" (114x114mm)	600	11.50	----	----	USP	3	24
	632		25.70	605	72.20	US3	3	24	
	633		18.30	606	54.10	US4	3	24	
	639		20.00	612	50.60	US10	3	24	
	640		24.30	613	68.10	US10B	3	24	
	641		24.30	614	65.00	US10A	3	24	
643	24.30		616	65.00	US11	3	24		
F643E/716	24.30		B643E/716	65.00	US11E	3	24		
646	24.30		619	53.90	US15	3	24	646 finish Stocked	
651	24.30		625	68.80	US26	3	24		
652	14.20		626	57.80	US26D	3	24	652 & 626 finish Stocked, 652 NRP Stocked	
F-BLK	20.00		B-BLK	50.60	US19	3	24	F-BLK finish Stocked	
----	----		629	74.60	US32	3	24		
----	----		630	67.50	US32D	3	24	630 finish Stocked, 630 NRP Stocked	

Note: Specify BHMA finish code when ordering.

 Indicates products that have EPD documentation available and meet LEED v4.

Contact Ives Customer Service for pricing on additional sizes and finishes

Bold pricing indicates item is in stock and available for **Fast Track** and **ProXpress**

HINGES
 CONTINUOUS HINGES
 PIVOTS
 Numerical 1-059
 Numerical 59-437
 Numerical 438-1021
 Numerical 1152-8190
 Numerical 8200-9266

DESCRIPTION	SIZE	STEEL BASED		BRASS / STAINLESS BASED		US REFERENCE	BOX	CASE	NOTES
		BHMA FINISH	LIST	BHMA FINISH	LIST				
 <p>Full Mortise Three Knuckle Concealed Bearing Standard Weight</p> <p>For use on standard weight doors with medium frequency usage</p> <p>Available in: Steel w/Steel Pin Brass w/Brass Pin Stainless w/Stainless Pin</p> <p>Non-removable Pin (Steel and Stainless Steel Based 4.5 x 4.5 Hinges add \$4.75 all others add \$9.50 list)</p> <p>Packed with: Wood and machine screws</p> <p>Available options: SEC - Security Screws HT - Hospital tip RC - Round corners SH - Security Studs TW - Electric Thru Wire See page 14 for pricing</p>	5"x4.5" (127x114mm)	600	\$27.50	----	\$ ----	USP	3	24	
		632	40.90	605	80.80	US3	3	24	
		633	28.80	606	67.50	US4	3	24	
		639	30.80	612	63.10	US10	3	24	
		640	40.90	613	80.80	US10B	3	24	
		641	40.90	614	80.80	US10A	3	24	
		643	42.50	616	80.80	US11	3	24	
		F643E/716	42.50	B643E/716	80.80	US11E	3	24	
		646	42.50	619	80.80	US15	3	24	
		651	40.90	625	85.50	US26	3	24	
		652	32.10	626	76.40	US26D	3	24	652 finish Stocked
		F-BLK	30.80	B-BLK	63.10	US19	3	24	
		----	----	629	92.80	US32	3	24	
		----	----	630	82.90	US32D	3	24	
	5"x5" (127x127mm)	600	48.90	----	----	USP	3	24	
	632	73.40	605	80.80	US3	3	24		
	633	52.10	606	67.50	US4	3	24		
	639	55.00	612	63.10	US10	3	24		
	640	73.40	613	80.80	US10B	3	24		
	641	73.40	614	80.80	US10A	3	24		
	643	76.40	616	80.80	US11	3	24		
	F643E/716	76.40	B643E/716	80.80	US11E	3	24		
	646	76.40	619	80.80	US15	3	24		
	651	73.40	625	85.50	US26	3	24		
652	61.00	626	76.40	US26D	3	24			
F-BLK	55.00	B-BLK	63.10	US19	3	24			
----	----	629	92.80	US32	3	24			
----	----	630	89.30	US32D	3	24			

Note: Specify BHMA finish code when ordering.

 Indicates products that have EPD documentation available and meet LEED v4.

Contact Ives Customer Service for pricing on additional sizes and finishes

Bold pricing indicates item is in stock and available for **Fast Track** and **ProXpress**

DESCRIPTION	SIZE	STEEL BASED		BRASS / STAINLESS BASED		US REFERENCE	BOX	CASE	NOTES
		BHMA FINISH	LIST	BHMA FINISH	LIST				
 <p>Full Mortise Three Knuckle Concealed Bearing Heavy Weight</p> <p>For use on heavy weight doors with medium frequency usage</p> <p>Available in: Steel w/Steel Pin Brass w/Brass Pin Stainless w/Stainless Pin</p> <p>Non-removable Pin (Steel and Stainless Steel Based 4.5 x 4.5 Hinges add \$4.75 all others add \$9.50 list)</p> <p>Packed with: Wood and machine screws</p> <p>Available options: SEC - Security Screws HT - Hospital tip RC - Round corners SH - Security Studs TW - Electric Thru Wire See page 14 for pricing</p>	4.5"x4" (114x102mm)	600	\$47.30	----	\$ ----	USP	3	24	
		632	60.80	605	119.90	US3	3	24	
		633	47.30	606	83.10	US4	3	24	
		639	50.30	612	77.40	US10	3	24	
		640	62.10	613	99.50	US10B	3	24	
		641	62.10	614	99.50	US10A	3	24	
		643	60.80	616	99.50	US11	3	24	
		F643E/716	60.80	B643E/716	99.50	US11E	3	24	
		646	64.60	619	76.90	US15	3	24	
		651	60.80	625	105.00	US26	3	24	
		652	48.90	626	94.20	US26D	3	24	
		F-BLK	50.30	B-BLK	77.40	US19	3	24	
		----	----	629	114.20	US32	3	24	
		----	----	630	103.50	US32D	3	24	
	4.5"x4.5" (114x114mm)	600	44.70	----	----	USP	3	24	
		632	60.80	605	119.90	US3	3	24	
		633	47.30	606	83.10	US4	3	24	
		639	50.30	612	77.40	US10	3	24	
		640	62.10	613	99.50	US10B	3	24	
		641	62.10	614	99.50	US10A	3	24	
		643	60.80	616	99.50	US11	3	24	
		F643E/716	60.80	B643E/716	99.50	US11E	3	24	
		646	57.50	619	76.90	US15	3	24	
		651	60.80	625	105.00	US26	3	24	
		652	48.90	626	94.20	US26D	3	24	652 finish Stocked, 652 NRP Stocked
		F-BLK	50.30	B-BLK	77.40	US19	3	24	
		----	----	629	114.20	US32	3	24	
		----	----	630	103.50	US32D	3	24	630 finish Stocked, 630 NRP Stocked
	5"x4.5" (127x114mm)	600	54.70	----	----	USP	3	24	
		632	71.70	605	135.50	US3	3	24	
		633	54.70	606	94.50	US4	3	24	
		639	57.80	612	88.30	US10	3	24	
		640	71.70	613	113.70	US10B	3	24	
		641	71.70	614	113.70	US10A	3	24	
		643	71.70	616	113.70	US11	3	24	
		F643E/716	71.70	B643E/716	113.70	US11E	3	24	
		646	74.30	619	90.90	US15	3	24	
		651	71.70	625	119.80	US26	3	24	
		652	56.20	626	107.50	US26D	3	24	652 finish Stocked, 652 NRP Stocked
		F-BLK	57.80	B-BLK	88.30	US19	3	24	
		----	----	629	129.90	US32	3	24	
		----	----	630	117.90	US32D	3	24	630 NRP finish Stocked
5"x5" (127x127mm)	600	54.70	----	----	USP	3	24		
	632	71.70	605	135.50	US3	3	24		
	633	54.70	606	94.50	US4	3	24		
	639	57.80	612	88.30	US10	3	24		
	640	71.70	613	113.70	US10B	3	24		
	641	71.70	614	113.70	US10A	3	24		
	643	71.70	616	113.70	US11	3	24		
	F643E/716	71.70	B643E/716	113.70	US11E	3	24		
	646	74.30	619	90.90	US15	3	24		
	651	71.70	625	119.80	US26	3	24		
	652	59.60	626	107.50	US26D	3	24		
	F-BLK	57.80	B-BLK	88.30	US19	3	24		
	----	----	629	129.90	US32	3	24		
	----	----	630	125.00	US32D	3	24		

Note: Specify BHMA finish code when ordering.

 Indicates products that have EPD documentation available and meet LEED v4.

Contact Ives Customer Service for pricing on additional sizes and finishes

Bold pricing indicates item is in stock and available for **Fast Track** and **ProXpress**

HINGES
 CONTINUOUS HINGES
 PIVOTS
 Numerical 1-059
 Numerical 59-437
 Numerical 438-1021
 Numerical 1152-8190
 Numerical 8200-9266

HINGES
 CONTINUOUS HINGES
 PIVOTS
 Numerical 1-059
 Numerical 59-437
 Numerical 438-1021
 Numerical 1152-8190
 Numerical 8200-9266

DESCRIPTION	SIZE	STEEL BASED		BRASS / STAINLESS BASED		US REFERENCE	BOX	CASE	NOTES
		BHMA FINISH	LIST	BHMA FINISH	LIST				
3CB1 WT  Three Knuckle Concealed Bearing Wide Throw Standard Weight For use on standard weight doors with medium frequency usage Available in: Steel w/Steel Pin Non-removable Pin (add \$9.50 List) Packed with: Wood and machine screws Available options: SEC - Security Screws HT - Hospital tip RC - Round corners SH - Security Studs TW - Electric Thru Wire See page 14 for pricing	4.5"x5" (127x114mm)	600	\$147.70	----	\$ ----	USP	3	24	
		632	221.40	605	----	US3	3	24	
		633	156.70	606	----	US4	3	24	
		639	165.80	612	----	US10	3	24	
		640	221.40	613	----	US10B	3	24	
		641	221.40	614	----	US10A	3	24	
		643	230.80	616	----	US11	3	24	
		F643E/716	230.80	B643E/716	----	US11E	3	24	
		646	230.80	619	----	US15	3	24	
		651	221.40	625	----	US26	3	24	
		652	184.40	626	----	US26D	3	24	
		F-BLK	165.80	B-BLK	----	US19	3	24	
		----	----	629	----	US32	3	24	
		----	----	630	----	US32D	3	24	
		4.5"x6" (114x152mm)	600	156.00	----	----	USP	3	24
	632		234.10	605	----	US3	3	24	
	633		165.60	606	----	US4	3	24	
	639		175.40	612	----	US10	3	24	
	640		234.10	613	----	US10B	3	24	
	641		234.10	614	----	US10A	3	24	
	643		244.00	616	----	US11	3	24	
	F643E/716		244.00	B643E/716	----	US11E	3	24	
	646		244.00	619	----	US15	3	24	
	651		234.10	625	----	US26	3	24	
	652		194.90	626	----	US26D	3	24	
	F-BLK		175.40	B-BLK	----	US19	3	24	
	----		----	629	----	US32	3	24	
	----		----	630	----	US32D	3	24	
	5"x6" (127x152mm)		600	164.60	----	----	USP	3	24
		632	246.70	605	----	US3	3	24	
		633	174.80	606	----	US4	3	24	
		639	184.80	612	----	US10	3	24	
		640	246.70	613	----	US10B	3	24	
		641	246.70	614	----	US10A	3	24	
		643	257.10	616	----	US11	3	24	
		F643E/716	257.10	B643E/716	----	US11E	3	24	
		646	257.10	619	----	US15	3	24	
		651	246.70	625	----	US26	3	24	
		652	205.60	626	----	US26D	3	24	
		F-BLK	184.80	B-BLK	----	US19	3	24	
		----	----	629	----	US32	3	24	
		----	----	630	----	US32D	3	24	
		5"x7" (127x178mm)	600	168.70	----	----	USP	3	24
	632		253.10	605	----	US3	3	24	
	633		179.10	606	----	US4	3	24	
639	189.80		612	----	US10	3	24		
640	253.10		613	----	US10B	3	24		
641	253.10		614	----	US10A	3	24		
643	263.30		616	----	US11	3	24		
F643E/716	263.30		B643E/716	----	US11E	3	24		
646	263.30		619	----	US15	3	24		
651	253.10		625	----	US26	3	24		
652	210.90		626	----	US26D	3	24		
F-BLK	189.80		B-BLK	----	US19	3	24		
----	----		629	----	US32	3	24		
----	----		630	----	US32D	3	24		

Note: Specify BHMA finish code when ordering.

Contact Ives Customer Service for pricing on additional sizes and finishes

Bold pricing indicates item is in stock and available for **Fast Track** and **ProXpress**

HINGES
 CONTINUOUS HINGES
 PIVOTS
 Numerical 1-059
 Numerical 59-437
 Numerical 438-1021
 Numerical 1152-8190
 Numerical 8200-9266

DESCRIPTION	SIZE	STEEL BASED		BRASS / STAINLESS BASED		US REFERENCE	BOX	CASE	NOTES
		BHMA FINISH	LIST	BHMA FINISH	LIST				
3CB1 WT  Three Knuckle Concealed Bearing Wide Throw Standard Weight For use on standard weight doors with medium frequency usage	5"x8" (127x204mm)	600	\$181.10	----	\$ ----	USP	3	24	
		632	272.10	605	----	US3	3	24	
		633	192.80	606	----	US4	3	24	
		639	204.00	612	----	US10	3	24	
		640	272.10	613	----	US10B	3	24	
		641	272.10	614	----	US10A	3	24	
		643	283.20	616	----	US11	3	24	
		F643E/716	283.20	B643E/716	----	US11E	3	24	
		646	283.20	619	----	US15	3	24	
		651	272.10	625	----	US26	3	24	
		652	226.60	626	----	US26D	3	24	
		F-BLK	204.00	B-BLK	----	US19	3	24	
		----	----	629	----	US32	3	24	
----	----	630	----	US32D	3	24			

DESCRIPTION	SIZE	STEEL BASED		BRASS / STAINLESS BASED		US REFERENCE	BOX	CASE	NOTES	
		BHMA FINISH	LIST	BHMA FINISH	LIST					
3SPI  Spring Hinge Standard Weight UL listed for use on fire-rated doors Available in: Steel w/ Steel Pin Stainless w/ Stainless Pin Packed with: Wood and machine screws Available options: SEC - Security Screws RC - Round corners See page 14 for pricing	4"x4" (102x102mm)	600	\$20.70	----	\$	USP	3	24		
		632	29.50	605	----	US3	3	24		
		633	23.70	606	----	US4	3	24		
		639	26.60	612	----	US10	3	24		
		640	34.00	613	----	US10B	3	24		
		641	32.40	614	----	US10A	3	24		
		643	29.50	616	----	US11	3	24		
		F643E/716	29.50	B643E/716	----	US11E	3	24		
		646	29.50	619	----	US15	3	24		
		651	29.50	625	----	US26	3	24		
		652	26.60	626	----	US26D	3	24		
		F-BLK	26.60	B-BLK	----	US19	3	24		
		----	----	629	----	US32	3	24		
		----	----	630	64.30	US32D	3	24		
		4.5"x4" (114x102mm)	600	20.70	----	----	----	USP	3	24
	632		29.50	605	----	----	US3	3	24	
	633		23.70	606	----	----	US4	3	24	
	639		26.60	612	----	----	US10	3	24	
	640		34.00	613	----	----	US10B	3	24	
	641		32.40	614	----	----	US10A	3	24	
	643		29.50	616	----	----	US11	3	24	
	F643E/716		29.50	B643E/716	----	----	US11E	3	24	
	646		29.50	619	----	----	US15	3	24	
	651		29.50	625	----	----	US26	3	24	
	652		26.60	626	----	----	US26D	3	24	652 finish Stocked
	F-BLK		26.60	B-BLK	----	----	US19	3	24	
	----		----	629	----	----	US32	3	24	
	----		----	630	64.30	US32D	3	24		
	4.5"x4.5" (114x114mm)		600	19.90	----	----	----	USP	3	24
		632	28.30	605	----	----	US3	3	24	
		633	22.70	606	----	----	US4	3	24	633 finish Stocked
		639	25.70	612	----	----	US10	3	24	
		640	32.60	613	----	----	US10B	3	24	640 finish Stocked
641		31.10	614	----	----	US10A	3	24		
643		28.30	616	----	----	US11	3	24		
F643E/716		28.30	B643E/716	----	----	US11E	3	24		
646		28.30	619	----	----	US15	3	24	646 finish Stocked	
651		28.30	625	----	----	US26	3	24		
652		26.60	626	----	----	US26D	3	24	652 finish Stocked	
F-BLK		25.70	B-BLK	----	----	US19	3	24	F-BLK finish Stocked	
----		----	629	70.30	US32	3	24			
----	----	630	75.10	US32D	3	24	630 finish Stocked			

Note: Specify BHMA finish code when ordering.

Lead time exception: Non-stocked Spring hinges and all Spring hinges with RC may take up to 10-12 weeks for shipment except 3SPI 4X4 652 RC-1/4

Contact Ives Customer Service for pricing on additional sizes and finishes

Bold pricing indicates item is in stock and available for **Fast Track** and **ProXpress**

HINGES
 CONTINUOUS HINGES
 PIVOTS
 Numerical 1-059
 Numerical 59-437
 Numerical 438-1021
 Numerical 1152-8190
 Numerical 8200-9266

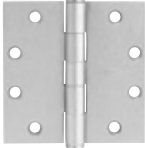

DESCRIPTION	SIZE	STEEL BASED		BRASS / STAINLESS BASED		US REFERENCE	BOX	CASE	NOTES
		BHMA FINISH	LIST	BHMA FINISH	LIST				
 <p>Five Knuckle Plain Bearing Standard Weight</p> <p>For use on standard weight doors with low frequency usage</p> <p>Available in: Steel w/Steel Pin Brass w/Brass Pin Stainless w/Stainless Pin</p> <p>Non-removable Pin (Steel and Stainless Steel Based 4.5 x 4.5 Hinges add \$4.75 all others add \$9.50 list)</p> <p>Packed with: Wood and machine screws</p> <p>Available options: SEC - Security Screws HT - Hospital tip RC - Round corners SH - Security Studs See page 14 for pricing</p>	3.5"x3.5" (89x89mm)	600	\$7.50	----	\$ ----	USP	3	24	
		632	10.80	605	28.30	US3	3	24	
		633	8.00	606	23.40	US4	3	24	
		639	11.20	612	22.20	US10	3	24	
		640	11.20	613	28.30	US10B	3	24	
		641	11.20	614	28.30	US10A	3	24	
		643	11.50	616	28.30	US11	3	24	
		F643E/716	11.50	B643E/716	28.30	US11E	3	24	
		646	11.50	619	28.30	US15	3	24	
		651	11.20	625	29.70	US26	3	24	
		652	9.30	626	26.50	US26D	3	24	652 finish Stocked
		F-BLK	11.20	B-BLK	22.20	US19	3	24	
	----	----	629	32.20	US32	3	24		
	----	----	630	31.10	US32D	3	24		
	4"x4" (102x102mm)	600	\$8.50	----	----	USP	3	24	
		632	13.00	605	32.30	US3	3	24	
		633	8.80	606	26.60	US4	3	24	
		639	9.60	612	25.20	US10	3	24	
		640	13.00	613	32.30	US10B	3	24	
		641	13.00	614	32.30	US10A	3	24	
		643	13.40	616	32.30	US11	3	24	
		F643E/716	13.40	B643E/716	32.30	US11E	3	24	
		646	13.40	619	32.30	US15	3	24	
		651	13.00	625	34.10	US26	3	24	
		652	10.70	626	30.50	US26D	3	24	
		F-BLK	9.60	B-BLK	25.20	US19	3	24	
	----	----	629	36.60	US32	3	24		
	----	----	630	35.50	US32D	3	24		
	4.5"x4" (114x102mm)	600	9.40	----	----	USP	3	24	
		632	15.20	605	43.90	US3	3	24	
		633	7.80	606	37.60	US4	3	24	
		639	9.40	612	37.60	US10	3	24	
		640	14.90	613	43.90	US10B	3	24	
		641	14.90	614	41.20	US10A	3	24	
		643	15.20	616	41.20	US11	3	24	
		F643E/716	15.20	B643E/716	41.20	US11E	3	24	
		646	15.20	619	43.90	US15	3	24	
		651	15.20	625	50.40	US26	3	24	
		652	12.40	626	38.90	US26D	3	24	
		F-BLK	9.40	B-BLK	37.60	US19	3	24	
	----	----	629	46.80	US32	3	24		
	----	----	630	44.60	US32D	3	24		
	4.5"x4.5" (114x114mm)	600	6.10	----	----	USP	3	24	
		632	15.30	605	43.90	US3	3	24	
		633	7.80	606	37.60	US4	3	24	
		639	9.40	612	37.60	US10	3	24	
		640	13.80	613	43.90	US10B	3	24	
		641	13.80	614	41.20	US10A	3	24	
643		15.20	616	41.20	US11	3	24		
F643E/716		15.20	B643E/716	41.20	US11E	3	24		
646		15.30	619	43.90	US15	3	24		
651		15.30	625	50.40	US26	3	24		
652		9.30	626	38.90	US26D	3	24	652 finish Stocked, 652 NRP Stocked	
F-BLK		9.40	B-BLK	37.60	US19	3	24		
----	----	629	46.80	US32	3	24			
----	----	630	44.60	US32D	3	24			

Note: Specify BHMA finish code when ordering.

 Indicates products that have EPD documentation available and meet LEED v4.

Contact Ives Customer Service for pricing on additional sizes and finishes

Bold pricing indicates item is in stock and available for **Fast Track** and **ProXpress**

DESCRIPTION	SIZE	STEEL BASED		BRASS / STAINLESS BASED		US REFERENCE	BOX	CASE	NOTES
		BHMA FINISH	LIST	BHMA FINISH	LIST				
 <p>5PB1</p> <p>Five Knuckle Plain Bearing Standard Weight</p> <p>For use on standard weight doors with low frequency usage</p>	5"x4.5" (127x114mm)	600	\$13.70	----	\$ ----	USP	3	24	
		632	20.90	605	63.50	US3	3	24	
		633	14.80	606	53.10	US4	3	24	
		639	15.30	612	49.40	US10	3	24	
		640	20.90	613	63.50	US10B	3	24	
		641	20.90	614	63.50	US10A	3	24	
		643	21.80	616	63.50	US11	3	24	
		F643E/716	21.80	B643E/716	63.50	US11E	3	24	
		646	21.80	619	63.50	US15	3	24	
		651	20.90	625	67.30	US26	3	24	
		652	17.60	626	60.20	US26D	3	24	
		F-BLK	15.30	B-BLK	49.40	US19	3	24	
		----	----	629	72.40	US32	3	24	
		----	----	630	69.50	US32D	3	24	
 <p>5BB1</p> <p>Five Knuckle Ball Bearing Standard Weight</p> <p>For use on standard weight doors with medium frequency usage</p> <p>Available in: Steel w/Steel Pin Brass w/Brass Pin Stainless w/Stainless Pin</p> <p>Non-removable Pin (Steel and Stainless Steel Based 4.5 x 4.5 Hinges add \$4.75 all others add \$9.50 list)</p> <p>Packed with: Wood and machine screws</p> <p>Available options: SEC - Security Screws HT - Hospital tip RC - Round corners SH - Security Studs TW - Electric Thru Wire</p> <p>See page 14 for pricing and available sizes</p>	3.5"x3.5" (89x89mm)	600	11.00	----	\$ ----	USP	3	24	
		632	16.70	605	40.60	US3	3	24	
		633	12.00	606	33.80	US4	3	24	
		639	12.70	612	31.60	US10	3	24	
		640	16.70	613	40.60	US10B	3	24	
		641	16.70	614	40.60	US10A	3	24	
		643	17.60	616	40.60	US11	3	24	
		F643E/716	17.60	B643E/716	40.60	US11E	3	24	
		646	17.60	619	40.60	US15	3	24	
		651	16.70	625	42.70	US26	3	24	
		652	13.10	626	38.20	US26D	3	24	652 finish Stocked
		F-BLK	12.70	B-BLK	31.60	US19	3	24	
		----	----	629	45.90	US32	3	24	
		----	----	630	41.40	US32D	3	24	
	4"x4" (102x102mm)	600	10.40	----	----	USP	3	24	
		632	16.70	605	39.30	US3	3	24	
		633	12.00	606	32.60	US4	3	24	
		639	12.70	612	30.60	US10	3	24	
		640	16.70	613	39.30	US10B	3	24	
		641	16.70	614	39.30	US10A	3	24	
		643	17.60	616	39.30	US11	3	24	
		F643E/716	17.60	B643E/716	39.30	US11E	3	24	
		646	17.60	619	39.30	US15	3	24	
		651	16.70	625	41.50	US26	3	24	
		652	13.10	626	37.10	US26D	3	24	652 finish Stocked
		F-BLK	12.70	B-BLK	30.60	US19	3	24	
		----	----	629	44.50	US32	3	24	
		----	----	630	42.70	US32D	3	24	
	4.5"x4" (114x102mm)	600	15.20	----	----	USP	3	24	
		632	21.70	605	52.10	US3	3	24	
		633	15.20	606	39.30	US4	3	24	
		639	17.30	612	39.30	US10	3	24	
		640	22.20	613	52.10	US10B	3	24	
		641	22.20	614	46.90	US10A	3	24	
643		21.70	616	46.90	US11	3	24		
F643E/716		21.70	B643E/716	46.90	US11E	3	24		
646		23.00	619	52.10	US15	3	24		
651		21.70	625	52.10	US26	3	24		
652		17.60	626	41.50	US26D	3	24	652 finish Stocked, 652 NRP Stocked	
F-BLK		17.30	B-BLK	39.30	US19	3	24		
----		----	629	53.00	US32	3	24		
----		----	630	47.90	US32D	3	24	630 finish Stocked, 630 NRP Stocked	

Note: Specify BHMA finish code when ordering.

 Indicates products that have EPD documentation available and meet LEED v4.

Contact Ives Customer Service for pricing on additional sizes and finishes

Bold pricing indicates item is in stock and available for **Fast Track** and **ProXpress**

HINGES
 CONTINUOUS HINGES
 PIVOTS
 Numerical 1-059
 Numerical 59-437
 Numerical 438-1021
 Numerical 1152-8190
 Numerical 8200-9266

DESCRIPTION	SIZE	STEEL BASED		BRASS / STAINLESS BASED		US REFERENCE	BOX	CASE	NOTES
		BHMA FINISH	LIST	BHMA FINISH	LIST				
 <p>Five Knuckle Ball Bearing Standard Weight</p> <p>For use on standard weight doors with medium frequency usage</p> <p>Available in: Steel w/Steel Pin Brass w/Brass Pin Stainless w/Stainless Pin</p> <p>Non-removable Pin (Steel and Stainless Steel Based 4.5 x 4.5 Hinges add \$4.75 all others add \$9.50 list)</p> <p>Packed with: Wood and machine screws</p> <p>Available options: SEC - Security Screws HT - Hospital tip RC - Round corners SH - Security Studs TW - Electric Thru Wire See page 14 for pricing</p>	4.5"x4.5" (114x114mm)	600	11.60	----	\$ ----	USP	3	24	600 finish Stocked, 600 NRP stocked
		632	20.40	605	49.00	US3	3	24	632 finish Stocked
		633	13.10	606	37.10	US4	3	24	633 & 606 finish Stocked
		639	16.30	612	37.10	US10	3	24	639 & 612 finish Stocked, 639 NRP stocked
		640	20.40	613	49.00	US10B	3	24	640 & 613 finish Stocked, 640 & 613 NRP Stocked
		641	20.40	614	46.90	US10A	3	24	
		643	20.40	616	46.90	US11	3	24	643 finish Stocked, 643 NRP Stocked
		F643E/716	20.90	B643E/716	46.90	US11E	3	24	F643E finish Stocked
		646	24.80	619	49.00	US15	3	24	646 & 619 finish Stocked, 646 & 619 NRP Stocked
		651	20.40	625	49.00	US26	3	24	651 & 625 finish Stocked
		652	13.10	626	41.50	US26D	3	24	652 & 626 finish Stocked, 652 & 626 NRP Stocked, 652 HT (Hospital Tip) Stocked
		F-BLK	16.60	B-BLK	37.90	US19	3	24	FBLK & BBLK finish Stocked, FBLK NRP Stocked
	----	----	629	53.00	US32	3	24		
	----	----	630	47.90	US32D	3	24	630 finish Stocked, 630 NRP stocked	
	5"x4.5" (127x114mm)	600	23.30	----	----	USP	3	24	
		632	35.20	605	59.70	US3	3	24	
		633	25.00	606	49.40	US4	3	24	
		639	26.30	612	46.20	US10	3	24	
		640	35.20	613	59.70	US10B	3	24	
		641	35.20	614	59.70	US10A	3	24	
		643	36.60	616	59.70	US11	3	24	
		F643E/716	36.60	B643E/716	59.70	US11E	3	24	
		646	36.60	619	59.70	US15	3	24	
		651	35.20	625	62.70	US26	3	24	
		652	27.60	626	56.20	US26D	3	24	652 finish Stocked, 652 NRP Stocked
		F-BLK	26.30	B-BLK	46.20	US19	3	24	
	----	----	629	67.40	US32	3	24		
	----	----	630	61.00	US32D	3	24	630 finish Stocked, 630 NRP Stocked	
	5"x5" (127x127mm)	600	23.70	----	----	USP	3	24	
		632	35.80	605	61.70	US3	3	24	
		633	25.20	606	51.20	US4	3	24	
		639	26.50	612	47.70	US10	3	24	
		640	35.80	613	61.70	US10B	3	24	
		641	35.80	614	61.70	US10A	3	24	
		643	37.00	616	61.70	US11	3	24	
		F643E/716	37.00	B643E/716	61.70	US11E	3	24	
646		37.00	619	61.70	US15	3	24		
651		35.80	625	64.90	US26	3	24		
652		29.50	626	57.90	US26D	3	24		
F-BLK		26.50	B-BLK	47.70	US19	3	24		
----	----	629	69.80	US32	3	24			
----	----	630	67.00	US32D	3	24			

Note: Specify BHMA finish code when ordering.

 Indicates products that have EPD documentation available and meet LEED v4.

Contact Ives Customer Service for pricing on additional sizes and finishes

Bold pricing indicates item is in stock and available for **Fast Track** and **ProXpress**

DESCRIPTION	SIZE	STEEL BASED		BRASS / STAINLESS BASED		US REFERENCE	BOX	CASE	NOTES
		BHMA FINISH	LIST	BHMA FINISH	LIST				
 <p>5BB1 HW</p> <p>Five Knuckle Ball Bearing Heavy Weight</p> <p>For use on heavy weight doors with medium frequency usage</p> <p>Available in: Steel w/Steel Pin Brass w/Brass Pin Stainless w/Stainless Pin</p> <p>Non-removable Pin (Steel and Stainless Steel Based 4.5 x 4.5 Hinges add \$4.75 all others add \$9.50 list)</p> <p>Packed with: Wood and machine screws</p> <p>Available options: SEC - Security Screws HT - Hospital tip RC - Round corners SH - Security Studs TW - Electric Thru Wire See page 14 for pricing</p>	4.5"x4" (114x102mm)	600	\$27.20	----	\$ ----	USP	3	24	
		632	40.90	605	77.00	US3	3	24	
		633	28.80	606	64.00	US4	3	24	
		639	30.60	612	60.00	US10	3	24	
		640	40.90	613	77.00	US10B	3	24	
		641	40.90	614	77.00	US10A	3	24	
		643	42.50	616	77.00	US11	3	24	
		F643E/716	42.50	B643E/716	77.00	US11E	3	24	
		646	42.50	619	77.00	US15	3	24	
		651	40.90	625	81.30	US26	3	24	
		652	31.80	626	72.70	US26D	3	24	652 finish Stocked, 652 NRP Stocked
		F-BLK	30.60	B-BLK	60.00	US19	3	24	
		----	----	629	86.90	US32	3	24	
		----	----	630	78.50	US32D	3	24	630 NRP finish Stocked
		4.5"x4.5" (114x114mm)	600	34.80	----	----	USP	3	24
	632		45.10	605	77.00	US3	3	24	
	633		36.30	606	64.00	US4	3	24	
	639		38.00	612	60.00	US10	3	24	639 finish Stocked
	640		45.10	613	81.50	US10B	3	24	640 & 613 finish Stocked, 613 & 640 NRP Stocked
	641		45.10	614	77.00	US10A	3	24	
	643		45.10	616	77.00	US11	3	24	643 NRP finish Stocked
	F643E/716		45.90	B643E/716	77.00	US11E	3	24	
	646		45.10	619	75.50	US15	3	24	646 finish Stocked
	651		45.10	625	81.30	US26	3	24	
	652		38.00	626	68.40	US26D	3	24	652 & 626 finish Stocked, 652 & 626 NRP Stocked, 652 HT (Hospital Tip) Stocked
	F-BLK		38.80	B-BLK	60.00	US19	3	24	FBLK finish Stocked
	----		----	629	86.90	US32	3	24	
	----		----	630	78.50	US32D	3	24	630 finish Stocked, 630 NRP Stocked
	5"x4.5" (127x114mm)		600	43.20	----	----	USP	3	24
		632	61.80	605	89.40	US3	3	24	
		633	44.80	606	74.80	US4	3	24	
		639	43.70	612	69.50	US10	3	24	
		640	52.50	613	89.40	US10B	3	24	
		641	55.80	614	89.40	US10A	3	24	
		643	44.80	616	89.40	US11	3	24	
F643E/716		44.80	B643E/716	89.40	US11E	3	24		
646		44.80	619	89.40	US15	3	24		
651		44.80	625	94.40	US26	3	24		
652		43.70	626	79.60	US26D	3	24	652 & 626 finish Stocked, 652 & 626 NRP Stocked, 652 HT (Hospital Tip) Stocked	
F-BLK		44.50	B-BLK	69.50	US19	3	24		
----		----	629	101.40	US32	3	24		
----		----	630	91.70	US32D	3	24	630 finish Stocked, 630 NRP Stocked	
5"x5" (127x127mm)		600	44.50	----	----	USP	3	24	
	632	66.70	605	103.70	US3	3	24		
	633	47.30	606	86.30	US4	3	24		
	639	50.20	612	80.60	US10	3	24		
	640	66.70	613	103.70	US10B	3	24		
	641	66.70	614	103.70	US10A	3	24		
	643	69.80	616	103.70	US11	3	24		
	F643E/716	69.80	B643E/716	103.70	US11E	3	24		
	646	69.80	619	103.70	US15	3	24		
	651	66.70	625	109.30	US26	3	24		
	652	53.80	626	97.80	US26D	3	24	652 finish Stocked	
	F-BLK	50.20	B-BLK	80.60	US19	3	24		
	----	----	629	117.30	US32	3	24		
	----	----	630	106.10	US32D	3	24	630 NRP Stocked	



Note: Specify BHMA finish code when ordering.

 Indicates products that have EPD documentation available and meet LEED v4.

Contact Ives Customer Service for pricing on additional sizes and finishes

Bold pricing indicates item is in stock and available for **Fast Track** and **ProXpress**

HINGES
 CONTINUOUS HINGES
 PIVOTS
 Numerical 1-059
 Numerical 59-437
 Numerical 438-1021
 Numerical 1152-8190
 Numerical 8200-9266

DESCRIPTION	SIZE	STEEL BASED		BRASS / STAINLESS BASED		US REFERENCE	BOX	CASE	NOTES
		BHMA FINISH	LIST	BHMA FINISH	LIST				
5BB1 SC  Five Knuckle Ball Bearing Swing Clear Standard Weight For use on standard weight doors with medium frequency usage Available in: Steel w/ Steel Pin Square or Beveled Edge Non-removable Pin (add \$9.50 List) Packed with: Wood and machine screws Available options: SEC - Security Screws HT - Hospital tip SH - Security Studs TW - Electric Thru Wire See page 14 for pricing	4.5" (114mm) Standard Weight Specific Square (5BB1 SC) or Beveled (5BB1 BSC) Edge	600	\$74.00	----	\$ ----	USP	3	24	
		632	86.90	605	----	US3	3	24	
		633	74.00	606	----	US4	3	24	
		639	77.20	612	----	US10	3	24	
		640	86.90	613	----	US10B	3	24	
		641	91.10	614	----	US10A	3	24	
		643	90.60	616	----	US11	3	24	
		F643E/716	90.60	B643E/716	----	US11E	3	24	
		646	90.60	619	----	US15	3	24	
		651	86.90	625	----	US26	3	24	
		652	68.40	626	----	US26D	3	24	SC/BSC 652 finish Stocked
		F-BLK	77.20	B-BLK	----	US19	3	24	
	----	----	629	----	US32	3	24		
	----	----	630	101.10	US32D	3	24		
	5" (127mm) Standard Weight Specific Square (5BB1 SC) or Beveled (5BB1 BSC) Edge	600	74.00	----	----	USP	3	24	
		632	86.90	605	----	US3	3	24	
		633	74.00	606	----	US4	3	24	
		639	77.20	612	----	US10	3	24	
		640	86.90	613	----	US10B	3	24	
		641	91.10	614	----	US10A	3	24	
		643	90.60	616	----	US11	3	24	
		F643E/716	90.60	B643E/716	----	US11E	3	24	
		646	90.60	619	----	US15	3	24	
		651	86.90	625	----	US26	3	24	
652		68.40	626	----	US26D	3	24		
F-BLK		77.20	B-BLK	----	US19	3	24		
----	----	629	----	US32	3	24			
----	----	630	117.80	US32D	3	24			
5BB1 HW SC  Five Knuckle Ball Bearing Swing Clear Heavyweight For use on heavy weight doors with medium frequency usage Available in: Steel w/ Steel Pin Square or Beveled Edge Non-removable Pin (add \$9.50 List) Packed with: Wood and machine screws Available options: SEC - Security Screws HT - Hospital tip SH - Security Studs TW - Electric Thru Wire See page 14 for pricing	4.5" (114mm) Heavy Weight Specific Square (5BB1 HWSC) or Beveled (5BB1 HWBSC) Edge	600	84.90	----	----	USP	3	24	
		632	105.60	605	----	US3	3	24	
		633	84.90	606	----	US4	3	24	
		639	93.90	612	----	US10	3	24	
		640	105.60	613	----	US10B	3	24	
		641	105.60	614	----	US10A	3	24	
		643	105.60	616	----	US11	3	24	
		F643E/716	105.60	B643E/716	----	US11E	3	24	
		646	110.10	619	----	US15	3	24	
		651	105.60	625	----	US26	3	24	
		652	82.90	626	----	US26D	3	24	SC/BSC 652 finish Stocked
		F-BLK	93.90	B-BLK	----	US19	3	24	
	----	----	629	----	US32	3	24		
	----	----	630	148.90	US32D	3	24		
	5" (127mm) Heavy Weight Specific Square (5BB1 HWSC) or Beveled (5BB1 HWBSC) Edge	600	84.90	----	----	USP	3	24	
		632	105.60	605	----	US3	3	24	
		633	84.90	606	----	US4	3	24	
		639	93.90	612	----	US10	3	24	
		640	105.60	613	----	US10B	3	24	
		641	105.60	614	----	US10A	3	24	
		643	105.60	616	----	US11	3	24	
		F643E/716	105.60	B643E/716	----	US11E	3	24	
		646	110.10	619	----	US15	3	24	
		651	105.60	625	----	US26	3	24	
652		82.90	626	----	US26D	3	24	SC/BSC 652 finish Stocked	
F-BLK		93.90	B-BLK	----	US19	3	24		
----	----	629	----	US32	3	24			
----	----	630	178.70	US32D	3	24			

Note: Specify BHMA finish code when ordering.

Lead time exception: Non-stocked Swing Clear hinges and all hinges with HT or SH may take up to 10-12 weeks for shipment except 5BB1SC 4.5 652 HT, 5BB1HW-SC 4.5 652 HT, 5BB1HW-SC 5 652 HT, and 5BB1HW-BSC 5 652 HT.

Contact Ives Customer Service for pricing on additional sizes and finishes

Bold pricing indicates item is in stock and available for **Fast Track** and **ProXpress**

DESCRIPTION	SIZE	STEEL BASED		BRASS / STAINLESS BASED		US REFERENCE	BOX	CASE	NOTES
		BHMA FINISH	LIST	BHMA FINISH	LIST				
5BB1 WT  Five Knuckle Ball Bearing Wide Throw Standard Weight For use on standard weight doors with medium frequency usage Available in: Steel w/Steel Pin Non-removable Pin (add \$9.50 List) Packed with: Wood and machine screws Available options: SEC - Security Screws HT - Hospital tip RC - Round corners SH - Security Studs TW - Electric Thru Wire See page 14 for pricing	4.5"x5" (114x127mm)	600	18.60	----	\$ ----	USP	3	24	
		632	28.00	605	----	US3	3	24	
		633	19.40	606	----	US4	3	24	
		639	20.90	612	----	US10	3	24	
		640	28.00	613	----	US10B	3	24	
		641	28.00	614	----	US10A	3	24	
		643	28.80	616	----	US11	3	24	
		F643E/716	28.80	B643E/716	----	US11E	3	24	
		646	28.80	619	----	US15	3	24	
		651	28.00	625	----	US26	3	24	
		652	23.00	626	----	US26D	3	24	652 finish Stocked
		F-BLK	20.90	B-BLK	----	US19	3	24	
		----	----	629	----	US32	3	24	
		----	----	630	----	US32D	3	24	
		4.5"x6" (114x152mm)	600	49.40	----	----	USP	3	24
	632		74.00	605	----	US3	3	24	
	633		52.50	606	----	US4	3	24	
	639		55.80	612	----	US10	3	24	
	640		74.00	613	----	US10B	3	24	
	641		74.00	614	----	US10A	3	24	
	643		77.20	616	----	US11	3	24	
	F643E/716		77.20	B643E/716	----	US11E	3	24	
	646		77.20	619	----	US15	3	24	
	651		74.00	625	----	US26	3	24	
	652		58.00	626	----	US26D	3	24	652 finish Stocked
	F-BLK		55.80	B-BLK	----	US19	3	24	
	----		----	629	----	US32	3	24	
	----		----	630	----	US32D	3	24	
	5"x6" (127x152mm)		600	66.70	----	----	USP	3	24
		632	99.80	605	----	US3	3	24	
		633	70.70	606	----	US4	3	24	
		639	75.20	612	----	US10	3	24	
		640	99.80	613	----	US10B	3	24	
		641	99.80	614	----	US10A	3	24	
		643	104.10	616	----	US11	3	24	
		F643E/716	104.10	B643E/716	----	US11E	3	24	
		646	104.10	619	----	US15	3	24	
		651	99.80	625	----	US26	3	24	
		652	83.30	626	----	US26D	3	24	
		F-BLK	75.20	B-BLK	----	US19	3	24	
----		----	629	----	US32	3	24		
----		----	630	----	US32D	3	24		
5"x7" (127x178mm)		600	66.70	----	----	USP	3	24	
	632	99.80	605	----	US3	3	24		
	633	70.70	606	----	US4	3	24		
	639	75.20	612	----	US10	3	24		
	640	99.80	613	----	US10B	3	24		
	641	99.80	614	----	US10A	3	24		
	643	104.10	616	----	US11	3	24		
	F643E/716	104.10	B643E/716	----	US11E	3	24		
	646	104.10	619	----	US15	3	24		
	651	99.80	625	----	US26	3	24		
	652	83.30	626	----	US26D	3	24		
	F-BLK	75.20	B-BLK	----	US19	3	24		
	----	----	629	----	US32	3	24		
	----	----	630	----	US32D	3	24		

Note: Specify BHMA finish code when ordering.

Contact Ives Customer Service for pricing on additional sizes and finishes

Bold pricing indicates item is in stock and available for **Fast Track** and **ProXpress**

DESCRIPTION	SIZE	STEEL BASED		BRASS / STAINLESS BASED		US REFERENCE	BOX	CASE	NOTES
		BHMA FINISH	LIST	BHMA FINISH	LIST				
 <p>5BB1 WT Five Knuckle Ball Bearing Wide Throw Standard Weight For use on standard weight doors with medium frequency usage</p>	5"x8" (127x206mm)	600	\$66.70	----	\$----	USP	3	24	
		632	99.80	605	----	US3	3	24	
		633	70.70	606	----	US4	3	24	
		639	75.20	612	----	US10	3	24	
		640	99.80	613	----	US10B	3	24	
		641	99.80	614	----	US10A	3	24	
		643	104.10	616	----	US11	3	24	
		F643E/716	104.10	B643E/716	----	US11E	3	24	
		646	104.10	619	----	US15	3	24	
		651	99.80	625	----	US26	3	24	
		652	83.30	626	----	US26D	3	24	
		F-BLK	75.20	B-BLK	----	US19	3	24	
		----	----	629	----	US32	3	24	
		----	----	630	----	US32D	3	24	

Note: Specify BHMA finish code when ordering.

BAA 5BB1 Five Knuckle Ball Bearing Standard Weight Build in America (BAA) Non-removable Pin (NRP) add \$4.75 List	4.5"x4.5" (114x114mm)	652	\$14.50	626	----	US26D	3	24	
		----	----	630	\$52.60	US32D	3	24	
BAA 5BB1 HW Five Knuckle Ball Bearing Heavy Weight Build in America (BAA) Non-removable Pin (NRP) add \$4.75 List	4.5"x4.5" (114x114mm)	652	\$41.50	626	----	US26D	3	24	
		----	----	630	\$85.80	US32D	3	24	
	5"x4.5" (127x114mm)	652	\$47.60	626	----	US26D	3	24	
		----	----	630	\$100.40	US32D	3	24	
BAA 5BB1 HW BSC Five Knuckle Ball Bearing Heavy Weight Build in America (BAA) Swing Clear - Beveled Edge	4.5" (114mm)	652	\$90.60	626	----	US26D	3	24	

Additional Options Available for Most Hinges

HINGE ADDITION/MODIFICATION	SPECIFY	LIST ADD PER HINGE
Non-Removable Pin	NRP	Reference each hinge type
Round Corners (specify 1/4" or 5/8" radius)	RC 1/4" or RC 5/8"	\$6.50
Security Studs (Includes NRP)	SH	\$9.00
Hospital Tips*	HT	\$11.75
Security Screws Machine Only	SEC	\$28.25

* Hospital Tips and Thru-Wire options include pins that are non-removable. Additional NRP option is not required.

Electric Thru-Wire Options*

Listed under UL 634

- TW4 - 4 Wire Thru Wire
- TW8 - 8 Wire Thru Wire
- TW12 - 12 Wire thru Wire
- MON - Monitor
- TW4M - 4 Wire Thru Wire with Monitor
- TW8M - 8 Wire Thru Wire with Monitor
- CON - Allegion Connect

All TW4 and TW8 3 knuckle and 5 knuckle hinges are standard with the Allegion Connect 8-pin Connector

- TW and MON not available for 3.5X3.5 hinges, contact technical support.
- MON not available for 4X4 or smaller hinges, contact technical support.
- Not available on 3PB1, 3SP1, or 5PB1 models
- Not available with Security Stud (SH) option
- Packed one hinge per box with machine and wood screws
- Through-wire hinges cycle tested to ensure durability. Ives warranty applies-12 months from date of shipment

MODEL NO.	BOX QTY	STEEL BASED		BRASS / STAINLESS BASED		ALLEGION CONNECT (CON)
		FULL MORTISE	SWING CLEAR	FULL MORTISE	SWING CLEAR	
*MON	1	346.00	-	409.00	-	std
TW4	1	332.00	662.00	392.00	777.00	std
TW4M	1	632.00	-	759.00	-	std
TW8	1	501.00	847.00	597.00	1193.00	std
TW8M	1	847.00	-	903.00	-	std
TW12	1	704.00	1049.00	800.00	1396.00	std

For Stocked Electric Thru Wire Hinges, see pricing in the table below. Options above are List Add per Hinge.

 Indicates products that have EPD documentation available and meet LEED v4. *Bold pricing indicates item is in stock and available for Fast Track and ProXpress*

Stocked Electric Thru-Wire Hinges

The hinges in the table below come standard with Allegion Connect (CON) at no extra charge.

DESCRIPTION	SIZE	TW OPTION	STEEL BASED BHMA FINISH	LIST	BRASS / STAINLESS BASED BHMA FINISH	LIST	US REFERENCE	BOX	CASE
3CB1	4.5X4.5	TW8 CON	652	\$486.90	626	---	US26D	1	12
3CB1 HW	4.5X4.5	TW8 CON	652	\$522.30	626	---	US26D	1	12
5BB1	4.5x4	TW8 CON	652	\$490.30	626	---	US26D	1	12
			---	---	630	---	US32D	1	12
	4.5x4.5	TW4 CON	652	\$326.50	626	\$412.50	US26D	1	12
			---	---	630	\$418.90	US32D	1	12
		TW8 CON	F-BLK	\$498.00	BBLK	---	US19	1	12
			652	\$485.90	626	\$605.10	US26D	1	12
	5x4.5	TW8 CON	---	---	630	\$611.70	US32D	1	12
			652	\$500.60	626	---	US26D	1	12
5BB1 HW	4.5X4.5	TW4 CON	652	\$351.90	626	---	US26D	1	12
			---	---	630	\$450.10	US32D	1	12
		TW8 CON	652	\$511.20	626	\$665.10	US26D	1	12
			---	---	630	\$642.60	US32D	1	12
	5X4.5	TW4 CON	652	\$357.90	626	---	US26D	1	12
			---	---	630	---	US32D	1	12
		TW8 CON	652	\$517.10	626	---	US26D	1	12
			---	---	630	\$656.10	US32D	1	12

For all other Electric Thru Wire Hinges, see pricing on previous page.

Residential Hinges

MODEL	SUBSTRATE	MODEL NUMBER	BHMA FINISH	WEIGHT	ORDER QTY	BOX QTY	LIST PRICE
1010* Residential Hinge 3.5" Square Corner	Steel	1010 F-619E	646			2	\$8.60
		1010 F-622E	-			2	8.60
		1010 F-625E	651			2	8.60
		1010 F-626E	652			2	8.60
		1010 F-716E	-			2	8.60
1011* Residential Hinge 3.5" 5/8" Radius Corner	Steel	1011F-605E	632			2	8.60
		1011F-619E	646			2	8.60
		1011 F-622E	-			2	8.60
		1011 F-625E	651			2	8.60
		1011 F-626E	652			2	8.60
		1011F-716E	-			2	8.60
1012* Residential Hinge 3.5" 1/4" Radius Corner	Steel	1012 F-619E	646			2	8.60
		1012 F-622E	-			2	8.60
		1012 F-625E	651			2	8.60
		1012 F-626E	652			2	8.60
		1012 F-716E	-			2	8.60
1020* Residential Hinge 4" Square Corner	Steel	1020 F-619E	646			2	9.40
		1020 F-622E	-			2	9.40
		1020 F-625E	651			2	9.40
		1020 F-626E	652			2	9.40
		1020 F-716E	-			2	9.40
1021* Residential Hinge 4" 5/8" Radius Corner	Steel	1021 F-619E	646			2	9.40
		1021 F-622E	-			2	9.40
		1021 F-625E	651			2	9.40
		1021 F-626E	652			2	9.40
		1021 F-716E	-			2	9.40

*Non rising pin standard. Hinge pin stop not recommended.

Contact Ives Customer Service for pricing on additional sizes and finishes

Bold pricing indicates item is in stock and available for **Fast Track** and **ProXpress**

Continuous Hinges - Pin and Barrel

STEEL BASED

MODEL	DESCRIPTION	FINISH	LENGTH	BHMA FINISH	LIST	NOTES
600 UL Listed 	600 Concealed Hinge 1/8" Inset Non Handed	USP	83"	600	\$336.80	
			85"	600	423.40	
			95"	600	411.20	
			120"	600	508.20	
602 UL Listed 	602 Full Surface Flush Mount Handed when cut or modified	USP	83"	600	378.70	
			85"	600	441.80	
			95"	600	441.80	
			120"	600	595.30	
611 UL Listed 	611 Swing Clear No Inset, Handed when cut or modified Built in Edge Guard	USP	83"	600	594.80	
			85"	600	673.70	
			95"	600	673.70	
			120"	600	781.10	
700 UL Listed 	700 Concealed Hinge 1/8" Inset Non Handed	US32D	83"	630	596.30	Stocked
			85"	630	690.40	Stocked
			95"	630	690.40	Stocked
			120"	630	843.40	
702 UL Listed 	702 Full Surface Flush Mount Handed when cut or modified	US32D	83"	630	690.40	
			85"	630	819.30	
			95"	630	819.30	
			120"	630	1,125.30	
705 UL Listed 	705 Concealed Hinge Handed when cut or modified Adjusta-Stud Fasteners	US32D	83"	630	778.10	Stocked
			85"	630	876.40	
			95"	630	876.40	
			120"	630	1,070.60	
711 UL Listed 	711 Swing Clear Flush Mounted Surface Hinge No Inset, Handed when cut or modified Built in Edge Guard	US32D	83"	630	669.10	
			85"	630	790.20	
			95"	630	767.50	
			120"	630	962.80	
715 UL Listed 	715 Concealed Hinge Flush Mounted, Half Wrap Handed when cut or modified Built in Edge Guard	US32D	83"	630	725.70	
			85"	630	819.70	
			95"	630	819.70	
			120"	630	1,016.60	

HINGES

CONTINUOUS HINGES

PIVOTS

Numerical 1-059

Numerical 59-437

Numerical 438-1021

Numerical 1152-8190

Numerical 8200-9266

Contact Ives Customer Service for pricing on additional sizes and finishes

Bold pricing indicates item is in stock and available for **Fast Track** and **ProXpress**

Pin & Barrel Continuous Hinges - Additional Offerings

Custom Processing*

Custom cut to length \$24.00 List add per hinge
 Custom painting colors Contact customer service for pricing and color approval. See Page v for additional information.
 Additional lead time up to 6 weeks may be needed.
 Add pricing below to base pricing for the size needed.

\$1,213.00 Flat rate for hinge quantity less than 12 for Tiger/Drylac paint
 \$101.00 List add per hinge for each hinge greater than 12.

Dutch Door Prep \$149.00 List add per hinge
 Hospital Tips \$149.00 List add per hinge. Exact size required when ordering, cannot be field modified.

* Return Policy - requires prior approval, consult factory

Electrical Modifications

EPT - Electrical Power Transfer prep \$129.00 List add per hinge
 600, 700, 705, and 715

TW8 - Electric Through-Wire \$421.00 List add per hinge
 600, 700, 705, and 715

CON - Allegion Connect \$58.00 List add per hinge (Must order with TW8 and add CON List Adder)
 600, 700, 705, and 715

Standard cutout locations. Top Edge of Door to Centerline of cutout.

Consult factory for custom locations. Specify location from top edge of door to centerline of cutout.
 TW8 location cannot be moved.

STD LENGTH	EPT	TW8
83"	30"	43-19/32"
85"	32"	45-17/32"
95"	42"	55-17/32"
120"	67"	80-17/32"

Optional Mounting Hardware

Standard Mounting Hardware \$0.00 No List Add
 Hollow Metal Self Drilling / Self Tapping Screws (TEK) for Door and Frame
 1/2 Wood Screws

Security Screws \$44.00 List add per hinge
 Hollow Metal Door and Frame Specify SECHM
 1/2 Wood, 1/2 Hollow Metal Specify SECWDHM
 Wood Door and Frame Specify SECWDWD

Wood Screws \$24.00 List add per hinge
 Wood Door and Frame Specify WD

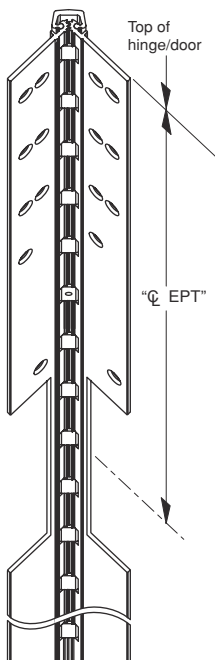

Ives Continuous Hinge - EPT Order Detail

(EPT's Measure from the top of the hinge to the centerline of the EPT Cutout)

Please supply the following information

_____ P/O Number

_____ Order #



_____ Length of Continuous Hinge

_____ Indicate RH or LH

_____ EPT Location

Note - EPT location is calculated from the TOP of the Hinge to the Centerline of the EPT cutout.

HINGES
 CONTINUOUS HINGES
 PIVOTS
 Numerical 1-059
 Numerical 59-437
 Numerical 438-1021
 Numerical 1152-8190
 Numerical 8200-9266

Model	Description	Lengths	List Price - Finishes Listed are for Aluminum Cover, Hinge leaves are Stainless Steel									
			441 (US32DAN)	600 (USP)	628 (US28)	688 (US4AN)	709 (US10AN)	710 (313AN)	711 (315AN)	712 (US26AN)	713 (US26DAN)	
			Satin Stainless Anodized	Primed Paint	Clear Anodized	Satin Brass Anodized	Satin Bronze Anodized	Dark Bronze Anodized	Black Anodized	Buff Chrome Anodized	Satin Chrome Anodized	
 700CS	700CS Stainless Steel Full Mortise Hinge w/ AL Cover	83"	768.40	825.60	689.20	768.40	768.40	718.50	718.50	768.40	768.40	
		85"	875.50	931.10	796.20	875.50	875.50	824.00	824.00	875.50	875.50	
		95"	896.30	951.90	817.10	896.30	896.30	838.00	838.00	896.30	896.30	
		120"	1,167.30	1,224.30	1,087.90	1,167.30	1,167.30	1,115.70	1,115.70	1,167.30	1,167.30	
	Stocked	700CS w/ TWP Stainless Steel Full Mortise Hinge w/ AL Cover, and Thru Wire Panel	83"	1,506.40	1,531.30	1,470.40	1,506.40	1,506.40	1,482.80	1,482.80	1,506.40	1,506.40
			85"	1,506.40	1,531.30	1,470.40	1,506.40	1,506.40	1,482.80	1,482.80	1,506.40	1,506.40
			95"	1,506.40	1,531.30	1,470.40	1,506.40	1,506.40	1,482.80	1,482.80	1,506.40	1,506.40
			120"	1,506.40	1,531.30	1,470.40	1,506.40	1,506.40	1,482.80	1,482.80	1,506.40	1,506.40
 711CS	711CS Stainless Steel Swing Clear Hinge w/ AL Cover	83"	843.40	881.10	790.80	843.40	843.40	810.20	810.20	843.40	843.40	
		85"	869.90	907.40	817.10	869.90	869.90	838.00	838.00	869.90	869.90	
		95"	928.20	965.70	875.50	928.20	928.20	897.60	897.60	928.20	928.20	
		120"	1,091.00	1,128.40	1,036.60	1,091.00	1,091.00	1,056.10	1,056.10	1,091.00	1,091.00	
 715CS	715CS Stainless Steel Full Mortise Hinge w/ Edge Guard and w/ AL Cover	83"	893.60	957.60	804.50	893.60	893.60	838.00	838.00	893.60	893.60	
		85"	1,013.10	1,077.00	922.80	1,013.10	1,013.10	953.30	953.30	1,013.10	1,013.10	
		95"	1,035.20	1,097.70	945.00	1,035.20	1,035.20	977.00	977.00	1,035.20	1,035.20	
		120"	1,349.20	1,413.40	1,258.90	1,349.20	1,349.20	1,291.30	1,291.30	1,349.20	1,349.20	

Lead time exception: Non-Stocked 711CS and 715CS Pin & Barrel Hinges may take up to 4-5 weeks for shipment. Cut to Length, EPT cutouts, and optional mounting hardware of stocked hinges will ship in 2 weeks or less

CS Series Continuous Hinges - Additional Offering

Custom Processing*

Custom cut to length \$48.00 List add per hinge
(All lengths = 13" from each end, TWP top only)

Custom painting colors Contact customer service for pricing and color approval. See Page v for additional information. Additional lead time up to 6 weeks may be needed.
Add pricing below to base 628 finish pricing for the size needed.
\$1,213.00 Flat rate for hinge quantity less than 12 for Tiger/Drylac paint
\$101.00 List add per hinge for each hinge greater than 12.

* Return Policy - requires prior approval, consult factory

Dutch Door Prep N/A List add per hinge
Hospital Tips N/A List add per hinge

Electrical Modifications

EPT - Electrical Power Transfer prep \$129.00 List add per hinge
700CS and 715CS
TW8 - Electric Through-Wire N/A See above chart for hinge price with TWP (Thru Wire Panel)
CON - Allegion Connect \$58.00 List add per hinge (Must order with TW8 and add CON List Adder)
700CS only

Standard cutout locations. Top Edge of Door to Centerline of cutout.

Consult factory for custom locations. Specify location from top edge of door to centerline of cutout.
TWP location cannot be moved.

STD LENGTH	EPT	TWP
83"	30"	43-13/16"
85"	32"	44-29/32"
95"	42"	55-9/32"
120"	67"	79-1/2"

Electrical Service Parts

700CS TWP Panel Service Kit \$987.00 List price

Optional Mounting Hardware



Standard Mounting Hardware \$0.00 No List Add
Hollow Metal Self Drilling / Self Tapping Screws (TEK) for Door and Frame
Security Screws \$44.00 List add per hinge
Hollow Metal Door and Frame Specify SECHM
Wood Screws \$24.00 List add per hinge
Wood Door and Frame Specify WD

Contact Ives Customer Service for pricing on additional sizes and finishes

Bold pricing indicates item is in stock and available for **Fast Track** and **ProXpress**

Continuous Geared Hinges

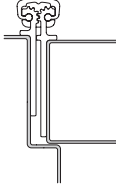
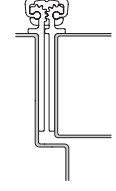
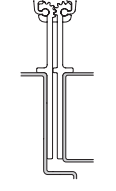
Aluminum Based

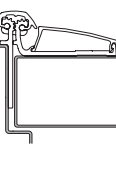
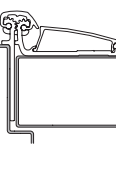
MODEL	DESCRIPTION	FINISH	LENGTH	BHMA FINISH	LIST	NOTES
026XY UL Listed 	026XY Heavy Duty Full Mortise - Narrow Frame Leaf, Wide Door Leaf 3/32" Inset Frame Leaf 1-9/16" Non Handed	US28	83"	628	\$262.20	
			85"	628	262.20	
			95"	628	319.00	
			119"	628	510.30	
		313AN	83"	710	326.00	
			85"	710	326.00	
			95"	710	418.30	
			119"	710	652.00	
		315AN	83"	711	374.90	
			85"	711	374.90	
			95"	711	480.80	
			119"	711	749.70	
027XY UL Listed 	027XY Heavy Duty Full Mortise - Wide Door Leaf Flush mounted, No inset Frame Leaf 1-7/8 " Non Handed	US28	83"	628	269.20	
			85"	628	269.20	
			95"	628	311.90	
			119"	628	503.30	
		313AN	83"	710	354.30	
			85"	710	354.30	
			95"	710	411.10	
			119"	710	645.00	
		315AN	83"	711	407.50	
			85"	711	407.50	
			95"	711	472.70	
			119"	711	741.70	
040XY UL Listed 	040XY Heavy Duty Full Mortise - Wide Throw Flush mounted, No inset Frame Leaf 1-11/16" Non Handed	US28	83"	628	460.70	
			85"	628	460.70	
			95"	628	566.90	
			119"	628	907.00	
		313AN	83"	710	602.40	
			85"	710	602.40	
			95"	710	722.80	
			119"	710	1,162.30	
		315AN	83"	711	692.80	
			85"	711	692.80	
			95"	711	831.20	
			119"	711	1,336.50	
041XY UL Listed 	041XY Heavy Duty Full Mortise - Swing Clear 1/16" inset Frame Leaf 1-7/8" Non Handed	US28	83"	628	510.30	
			85"	628	510.30	
			95"	628	609.30	
			119"	628	935.40	
		313AN	83"	710	673.30	
			85"	710	673.30	
			95"	710	807.80	
			119"	710	1,211.90	
		315AN	83"	711	774.30	
			85"	711	774.30	
			95"	711	929.00	
			119"	711	1,393.60	
045XY UL Listed 	045XY Heavy Duty Adjustable Half Surface 9/32" Inset Frame leaf 1-9/16" Non Handed	US28	83"	628	530.60	
			85"	628	530.60	
			95"	628	647.00	
			119"	628	970.50	
		313AN	83"	710	711.70	
			85"	710	711.70	
			95"	710	873.50	
			119"	710	1,294.10	
		315AN	83"	711	818.40	
			85"	711	818.40	
			95"	711	1,004.60	
			119"	711	1,488.10	
046XY UL Listed 	046XY Heavy Duty Adjustable Half Surface 9/32" Inset Frame leaf 1-7/8" Non Handed	US28	83"	628	569.40	
			85"	628	569.40	
			95"	628	698.90	
			119"	628	1,041.80	
		313AN	83"	710	763.50	
			85"	710	763.50	
			95"	710	931.70	
			119"	710	1,384.60	
		315AN	83"	711	878.00	
			85"	711	878.00	
			95"	711	1,071.50	
			119"	711	1,592.30	



Contact Ives Customer Service for pricing on additional sizes and finishes

Bold pricing indicates item is in stock and available for **Fast Track** and **ProXpress**

HINGES
CONTINUOUS HINGES
PIVOTS
Numerical 1-059
Numerical 59-437
Numerical 438-1021
Numerical 1152-8190
Numerical 8200-9266

Continuous Geared Hinges

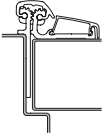
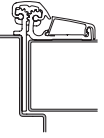
Aluminum Based

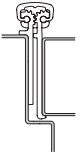
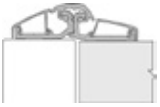

MODEL	DESCRIPTION	FINISH	LENGTH	BHMA FINISH	LIST	NOTES
053XY UL Listed 	053XY Heavy Duty Adjustable Half Surface 1/8" Inset Frame leaf 1-9/16" Non Handed	US28	83"	628	\$386.40	
			85"	628	386.40	
			95"	628	474.50	
			119"	628	732.00	
		313AN	83"	710	481.30	
			85"	710	481.30	
			95"	710	576.20	
			119"	710	976.10	
		315AN	83"	711	553.60	
			85"	711	553.60	
			95"	711	662.60	
			119"	711	1,122.50	
054XY UL Listed 	054XY Heavy Duty Adjustable Half Surface 1/8" Inset Frame leaf 1-7/8" Non Handed	US28	83"	628	413.50	
			85"	628	413.50	
			95"	628	488.00	
			119"	628	766.00	
		313AN	83"	710	494.80	
			85"	710	494.80	
			95"	710	589.80	
			119"	710	982.80	
		315AN	83"	711	569.00	
			85"	711	569.00	
			95"	711	678.30	
			119"	711	1,130.30	
112HD UL Listed 	112HD Heavy Duty Full Mortise No Inset, Non Handed Frame leaf 1-9/16"	US28	83"	628	191.90	Stocked, EPT @ 30" Stocked
			85"	628	191.90	Stocked
			95"	628	239.20	Stocked, EPT @ 42" Stocked
			120"	628	382.30	
		313AN	83"	710	247.70	Stocked
			85"	710	260.20	
			95"	710	309.30	
			120"	710	524.80	
112XY UL Listed 	112XY Heavy Duty Full Mortise - Narrow Frame Leaf, Narrow Door Leaf No Inset, Frame Leaf 1-9/16" Non Handed	US28	83"	628	240.90	Stocked
			85"	628	240.90	Stocked [112XY US28 95"]
			95"	628	304.90	
			119"	628	481.90	
		313AN	83"	710	311.90	
			85"	710	311.90	
			95"	710	389.90	
			119"	710	630.80	
		315AN	83"	711	358.70	
			85"	711	358.70	
			95"	711	448.30	
			119"	711	725.40	
114XY UL Listed 	114XY Heavy Duty Full Mortise - Narrow Frame Leaf, Door Edge Protector 1/16" inset Frame Leaf 1-9/16" Non Handed	US28	83"	628	255.10	
			85"	628	255.10	
			95"	628	311.90	
			119"	628	503.30	
		313AN	83"	710	319.00	
			85"	710	319.00	
			95"	710	411.10	
			119"	710	645.00	
		315AN	83"	711	366.80	
			85"	711	366.80	
			95"	711	472.70	
			119"	711	741.70	
157XY UL Listed 	157XY Heavy Duty Adjustable Full Surface Center Pivot 1/16" Inset Non Handed	US28	83"	628	297.30	Stocked
			95"	628	390.00	
			119"	628	662.80	
		313AN	83"	710	356.40	
			95"	710	467.90	
			119"	710	732.10	
		315AN	83"	711	409.80	
			95"	711	538.20	
			119"	711	842.00	

Contact Ives Customer Service for pricing on additional sizes and finishes

Bold pricing indicates item is in stock and available for **Fast Track** and **ProXpress**

Continuous Geared Hinges

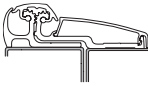
Aluminum Based

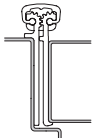
MODEL	DESCRIPTION	FINISH	LENGTH	BHMA FINISH	LIST	NOTES		
210XY UL Listed 	210XY Heavy Duty Adjustable Full Surface Swing Clear 1/32" Inset Non Handed	US28	83"	628	\$352.50			
			85"	628	352.50			
			95"	628	413.50			
			119"	628	718.50			
		313AN	83"	710	413.50			
			85"	710	413.50			
			95"	710	508.40			
			119"	710	786.20			
		315AN	83"	711	475.40			
			85"	711	475.40			
			95"	711	584.60			
			119"	711	904.20			
224HD UL Listed 	224HD Heavy Duty Full Mortise 1/16" Inset Non Handed	US28	83"	628	204.80	Stocked, EPT @ 30" Stocked, TEK/WD mounting Stocked.		
			85"	628	204.80			
			95"	628	252.10	Stocked		
			120"	628	396.80			
		313AN	83"	710	254.90			
			85"	710	267.70			
			95"	710	339.90			
			120"	710	534.00			
		224XY UL Listed 	224XY Heavy Duty Full Mortise - Door Edge Protector 1/16" inset Frame Leaf 1-7/8" Non Handed (Handed with HT, TWP, EPT)	US28	83"	628	255.10	Stocked
					85"	628	255.10	
95"	628				311.90			
119"	628				503.30			
313AN	83"			710	319.00			
	85"			710	319.00			
	95"			710	411.10			
	119"			710	645.00			
315AN	83"			711	366.80			
	85"			711	366.80			
	95"			711	472.70			
	119"			711	741.70			

HINGES
 CONTINUOUS HINGES
 PIVOTS
 Numerical 1-059
 Numerical 59-437
 Numerical 438-1021
 Numerical 1152-8190
 Numerical 8200-9266

Contact Ives Customer Service for pricing on additional sizes and finishes

Bold pricing indicates item is in stock and available for **Fast Track** and **ProXpress**

Continuous Geared Hinges

Geared Hinges - Additional Offerings

Custom Processing*

Custom cut to length	HD Models	\$23.00	List add per hinge
	XY Models	\$46.00	List add per hinge
Custom painting and anodized colors		Contact customer service for pricing and color approval. See Page v for additional information. Additional lead time up to 6 weeks may be needed.	
		\$1,166.00	Flat rate for hinge quantity less than 12 for Tiger/Drylac paint
		\$97.00	List add per hinge for each hinge greater than 12.

* Return Policy - requires prior approval, consult factory

Hospital Tip (HT)

HT - Hospital Tip		\$143.00	List add per hinge. Exact size required when ordering, cannot be field modified.
-------------------	--	----------	--

026XY, 027XY, 040XY, 112XY, 114XY, 224XY, and 936HD only
(no additional list add for 936HD)

Electrical Modifications

EPT - Electrical Power Transfer prep		\$124.00	List add per hinge
026XY, 027XY, 112HD, 112XY, 114XY, 224HD, and 224XY only			
TWP CON - Electric Through-Wire Panel with Allegion Connect		\$580.00	List add per hinge
026XY, 027XY, 112XY, 114XY, and 224XY only			

Standard cutout locations. Top Edge of Door to Centerline of cutout.

Consult factory for custom locations. Specify location from top edge of door to centerline of cutout.

STD LENGTH	HD EPT	XY EPT	XY TWP
83"	30"	30"	43.5"
85"	32"	32"	45.5"
95"	42"	42"	55.5"
119" (XY)	-	66"	79.5"
120" (HD)	67"	-	-

Electrical Service Parts

XY TWP Panel Service Kit		\$345.00	List price
<i>Same panel for all models (026XY, 027XY, 112XY, 114XY, 224XY)</i>			
<i>Use HGPART.1159 for US28, HGPART.1160 for 313AN</i>			
112HD TWP Panel Service Kit		\$293.00	List price
<i>Use 840737-28 for US28, 840737-42 for 313AN</i>			
224HD TWP Panel Service Kit		\$293.00	List price
<i>Use 840738-28 for US28, 84073842 for 313AN</i>			
112HD/224HD 6' Power Cable Kit for TW8 and TWP		\$414.00	List price
<i>Contains LH & RH cable - 840738-00</i>			

Optional Mounting Hardware

Standard Mounting Hardware		\$0.00	No List add
Hollow Metal Self Drilling / Self Tapping Screws (TEK) for Door and Frame			
Security Screws - Hex Pin Drive		\$42.00	List add per hinge
Hollow Metal Door and Frame			
1/2 Wood, 1/2 Hollow Metal			
Wood Door and Frame			
Wood Screws		\$23.00	List add per hinge
Wood Door and Frame			
1/2 Self Drill, Self Tap, 1/2 Wood			
Thread Forming Screws		\$23.00	List add per hinge
Hollow Metal Door and Frame			
1/2 Thread Forming, 1/2 Wood			
(Pilot holes required. Recommended for grout filled frame)			

Contact Ives Customer Service for pricing on additional sizes and finishes

Bold pricing indicates item is in stock and available for **Fast Track** and **ProXpress**

HINGES
CONTINUOUS HINGES
PIVOTS
Numerical 1-059
Numerical 59-437
Numerical 438-1021
Numerical 1152-8190
Numerical 8200-9266

MOUNTING HARDWARE

Standard Hardware Included - Hollow Metal Door and Frame		
Full Mortise Hinges	12-24 x 3/4" Steel Self Drilling/Self Tapping, Flat Head, Phillips Screw (TEK)	
Half Surface Hinges	12-24 x 3/4" Steel Self Drilling/Self Tapping, Flat Head, Phillips Screw (TEK)	
Includes 210XY	12-24 x 3/4" Steel Self Drilling/Self Tapping, Hex Head Screw (TEK)	
Full Surface Hinges	12-24 x 3/4" Steel Self Drilling/Self Tapping, Hex Head Screw (TEK)	
157XY Only		
Security Screws - Hollow Metal Door and Frame (SECHM)		
Full Mortise Hinges	12-24 x 3/4" Stainless Steel, Flat Head, Hex Pin Security Machine Screw	
112HD and 224HD Only		
Available as Accessory Parts Kit for Full Mortise XY Hinges (026XY, 027YX, 040XY, 041XY, 112XY, 112XY, 114XY, 224XY)		
Security Screws - 1/2 Wood, 1/2 Hollow Metal (SECWDHM)		
Full Mortise Hinges	12-24 x 3/4" Stainless Steel, Flat Head, Hex Pin Security Machine Screw	
112HD and 224HD Only	12-24 x 3/4" Stainless Steel Socket, Flat Head, Hex Pin Security Wood Screw	
Available as Accessory Parts Kit for Full Mortise XY Hinges (026XY, 027YX, 040XY, 041XY, 112XY, 112XY, 114XY, 224XY)		
Security Screws - Wood Door and Frame (SECWDWD)		
Full Mortise Hinges	12 X 1 1/4" Stainless Steel, Flat Head, Hex Pin Security Wood Screw	
112HD and 224HD Only		
Available as Accessory Parts Kit for Full Mortise XY Hinges (026XY, 027XY, 040XY, 041XY, 112XY, 114XY, 224XY)		
Wood Door and Frame (WD)		
Full Mortise Hinges	12 x 1-1/4" Flat Head, Phillips Screw	
Half Surface Hinges	12 x 1-1/4" Flat Head, Phillips Screw	
Includes 210XY	1/4 x 1-1/2" Hex Head Lag Screw	
Full Surface Hinges	1/4 x 1-1/2" Hex Head Lag Screw	
157XY Only		
1/2 Self Drill, Self Tap 1/2 Wood (TEKWD)		
Full Mortise Hinges	12-24 x 3/4" Steel Self Drilling/Self Tapping, Flat Head, Phillips Screw (TEK)	12 x 1-1/4" Flat Head, Phillips Wood Screw
Half Surface Hinges	12-24 x 3/4" Steel Self Drilling/Self Tapping, Flat Head, Phillips Screw (TEK)	1/4 x 1-1/2" Hex Head, Lag Screw
Full Surface Hinges	12-24 x 3/4" Steel Self Drilling/Self Tapping, Hex Head Screw (TEK)	1/4 x 1-1/2" Hex Head, Lag Screw
Thread Forming- Hollow Metal Door and Frame (TF)		
Full Mortise Hinges	12-24 x 3/4" Steel Thread Forming, Flat Head, Phillips Wood Screw	
112HD and 224HD Only		
Available as Accessory Parts Kit for Full Mortise XY Hinges (026XY, 027YX, 040XY, 041XY, 112XY, 112XY, 114XY, 224XY)		
Thread Forming - 1/2 Thread Forming Hollow Metal, 1/2 Wood (TFWD)		
Full Mortise Hinges	12-24 x 3/4" Steel Thread Forming, Flat Head, Phillips Screw	
112HD and 224HD Only	12 x 1 1/4" Flat Head, Phillips Wood Screw	
Available as Accessory Parts Kit for Full Mortise XY Hinges (026XY, 027XY, 040XY, 041XY, 112XY, 114XY, 224XY)		

HINGES
 CONTINUOUS HINGES
 PIVOTS
 Numerical 1-059
 Numerical 59-437
 Numerical 438-1021
 Numerical 1152-8190
 Numerical 8200-9266

Templates and installation instructions available on line at www.allegion.com/us

Contact Ives Customer Service for pricing on additional sizes and finishes

Bold pricing indicates item is in stock and available for **Fast Track** and **ProXpress**

Pivots

MODEL	PART DESCRIPTION	POUND RATING	BOX QTY	US3	US4	US10	US10B	US15	US26 *US32	US26D *US32D	643e 716	SP28	SP10	BLK	SP313	SP4
7212 3/4" Offset Pivot	7212 SET	200	1	457.90	457.90	457.90	457.90	457.90	457.90	418.20	457.90	265.90	265.90	265.90	265.90	265.90
	7212 TOP	-	1	265.90	265.90	265.90	265.90	265.90	265.90	228.90	265.90	162.10	162.10	162.10	162.10	162.10
	7212 BTM	200	1	278.70	278.70	278.70	278.70	278.70	278.70	238.90	278.70	182.00	182.00	182.00	182.00	182.00
	7212 INT	100	1	305.80	305.80	305.80	305.80	305.80	305.80	265.90	305.80	210.60	210.60	210.60	210.60	210.60
7212V 3/4" Offset Pivot, Jamb Mount	7212V SET	200	1	476.30	476.30	476.30	476.30	476.30	476.30	437.90	476.30	362.50	362.50	362.50	362.50	362.50
	7212V TOP	-	1	278.70	278.70	278.70	278.70	278.70	278.70	238.90	278.70	182.00	182.00	182.00	182.00	182.00
	7212V INT	100	1	305.80	305.80	305.80	305.80	305.80	305.80	265.90	305.80	210.60	210.60	210.60	210.60	210.60
7215 3/4" Offset Pivot	7215 SET	500	1	495.00	495.00	495.00	495.00	495.00	495.00	457.90	495.00	399.70	399.70	399.70	399.70	399.70
	7215 TOP	-	1	265.90	265.90	265.90	265.90	265.90	265.90	228.90	265.90	162.10	162.10	162.10	162.10	162.10
	7215 BTM	500	1	305.80	305.80	305.80	305.80	305.80	305.80	285.90	305.80	311.40	311.40	311.40	311.40	311.40
	7215 INT	100	1	278.70	278.70	278.70	278.70	278.70	278.70	247.50	278.70	228.90	228.90	228.90	228.90	228.90
	7215PT INT TW4	-	1	997.20	997.20	997.20	997.20	997.20	997.20	773.80	997.20	724.50	724.50	724.50	724.50	724.50
	7215PT INT TW8			1,163.60	1,163.60	1,163.60	1,163.60	1,163.60	1,163.60	940.20	1,163.60	890.90	890.90	890.90	890.90	890.90
7215F Fire Rated 3/4" Offset Pivot	7215F SET	500	1	780.90	-	780.90	-	-	780.90	740.70	780.90	608.90	608.90	608.90	608.90	608.90
	7215F TOP	-	1	467.90	-	467.90	-	-	467.90	410.90	467.90	342.80	342.80	342.80	342.80	342.80
	7215F BTM	500	1	544.90	-	544.90	-	-	544.90	504.70	544.90	399.70	399.70	399.70	399.70	399.70
	7215F INT	100	1	437.90	-	437.90	-	-	437.90	418.20	437.90	354.10	354.10	354.10	354.10	354.10
	7215FPT INT TW4			1,156.40	-	1,156.40	-	-	1,156.40	944.40	1,156.40	849.70	849.70	849.70	849.70	849.70
	7215FPT INT TW8			1,361.30	-	1,361.30	-	-	1,361.30	1,149.30	1,361.30	1,054.60	1,054.60	1,054.60	1,054.60	1,054.60
7222 3/4" Offset Pivot	7222 SET	200	1	399.70	399.70	399.70	399.70	399.70	399.70	362.50	399.70	265.90	265.90	265.90	265.90	265.90
	7222 TOP	-	1	265.90	265.90	265.90	265.90	265.90	265.90	228.90	265.90	162.10	162.10	162.10	162.10	162.10
	7222 BTM	200	1	259.00	259.00	259.00	259.00	259.00	259.00	220.40	259.00	153.60	153.60	153.60	153.60	153.60
	7222 INT	100	1	305.80	305.80	305.80	305.80	305.80	305.80	265.90	305.80	210.60	210.60	210.60	210.60	210.60
7226 3/4" Offset Pivot	7226 SET	600	1	476.30	476.30	476.30	476.30	476.30	476.30	437.90	476.30	342.80	342.80	342.80	342.80	342.80
	7226 TOP	-	1	265.90	265.90	265.90	265.90	265.90	265.90	228.90	265.90	162.10	162.10	162.10	162.10	162.10
	7226 BTM	600	1	285.90	285.90	285.90	285.90	285.90	285.90	265.90	285.90	238.90	238.90	238.90	238.90	238.90
	7226 INT	100	1	278.70	278.70	278.70	278.70	278.70	278.70	247.50	278.70	228.90	228.90	228.90	228.90	228.90
	7226PT INT TW4	-	1	997.20	997.20	997.20	997.20	997.20	997.20	773.80	997.20	724.50	724.50	724.50	724.50	724.50
	7226PT INT TW8			1,163.60	1,163.60	1,163.60	1,163.60	1,163.60	1,163.60	940.20	1,163.60	890.90	890.90	890.90	890.90	890.90

Lead time exception: The following Pivots are stocked.

7215 Set US26D, 7226 Set US26D, 7230F Set US32D, 7253 Set US26D, 7255 Set US26D, 7215-7226-7227 INT US26D

Non-Stocked PT INT pivots may take up to 4-5 weeks for shipment.

Contact Ives Customer Service for pricing on additional sizes and finishes

Bold pricing indicates item is in stock and available for **Fast Track** and **ProXpress**

Pivots

MODEL	PART DESCRIPTION	POUND RATING	BOX QTY	US3	US4	US10	US10B	US15	US26 *US32	US26D *US32D	643e 716	SP28	SP10	BLK	SP313	SP4
7226F Fire Rated 3/4" Offset Pivot	7226F SET	600	1	685.60	-	685.60	-	-	685.60	648.50	685.60	551.90	551.90	551.90	551.90	551.90
	7226F TOP	-	1	467.90	-	467.90	-	-	467.90	410.90	467.90	342.80	342.80	342.80	342.80	342.80
	7226F BTM	600	1	486.40	-	486.40	-	-	486.40	418.20	486.40	392.60	392.60	392.60	392.60	392.60
	7226F INT	600	1	437.90	-	437.90	-	-	437.90	418.20	437.90	354.10	354.10	354.10	354.10	354.10
	7226FPT INT TW4			1,156.40	-	1,156.40	-	-	1,156.40	944.40	1,156.40	849.70	849.70	849.70	849.70	849.70
	7226FPT INT TW8			1,361.30	-	1,361.30	-	-	1,361.30	1,149.30	1,361.30	1,054.60	1,054.60	1,054.60	1,054.60	1,054.60
7227 3/4" Offset Pivot	7227 SET	700	1	800.60	800.60	800.60	800.60	800.60	800.60	762.50	800.60	667.00	667.00	667.00	667.00	667.00
	7227 TOP	-	1	265.90	265.90	265.90	265.90	265.90	265.90	228.90	265.90	162.10	162.10	162.10	162.10	162.10
	7227 BTM	700	1	723.80	723.80	723.80	723.80	723.80	723.80	648.50	723.80	600.30	600.30	600.30	600.30	600.30
	7227 INT	100	1	278.70	278.70	278.70	278.70	278.70	278.70	247.50	278.70	228.90	228.90	228.90	228.90	228.90
	7227PT INT TW4	-	1	997.20	997.20	997.20	997.20	997.20	997.20	773.80	997.20	724.50	724.50	724.50	724.50	724.50
	7227PT INT TW8			1,163.60	1,163.60	1,163.60	1,163.60	1,163.60	1,163.60	940.20	1,163.60	890.90	890.90	890.90	890.90	890.90
7227F Fire Rated 3/4" Offset Pivot	7227F SET	700	1	1,008.30	-	1,008.30	-	-	1,008.30	970.10	1,008.30	856.20	856.20	856.20	856.20	856.20
	7227F TOP	-	1	467.90	-	467.90	-	-	467.90	410.90	467.90	342.80	342.80	342.80	342.80	342.80
	7227F BTM	700	1	723.80	-	723.80	-	-	723.80	648.50	723.80	600.30	600.30	600.30	600.30	600.30
	7227F INT	100	1	437.90	-	437.90	-	-	437.90	418.20	437.90	354.10	354.10	354.10	354.10	354.10
	7227FPT INT TW4			1,156.40	-	1,156.40	-	-	1,156.40	944.40	1,156.40	849.70	849.70	849.70	849.70	849.70
	7227FPT INT TW8			1,361.30	-	1,361.30	-	-	1,361.30	1,149.30	1,361.30	1,054.60	1,054.60	1,054.60	1,054.60	1,054.60
7230F Fire Rated 3/4" Offset Pivot	7230F SET	1000	1	856.20	-	856.20	-	-	856.20	817.60	856.20	723.80	723.80	723.80	723.80	723.80
	7230F TOP	-	1	437.90	-	437.90	-	-	437.90	410.90	437.90	354.10	354.10	354.10	354.10	354.10
	7230F BTM	1000	1	524.60	-	524.60	-	-	524.60	504.70	524.60	448.00	448.00	448.00	448.00	448.00
	7230F INT	100	1	476.30	-	476.30	-	-	476.30	457.90	476.30	392.60	392.60	392.60	392.60	392.60
	7230FPT INT TW4			1,194.80	-	1,194.80	-	-	1,194.80	984.20	1,194.80	888.20	888.20	888.20	888.20	888.20
	7230FPT INT TW8			1,361.20	-	1,361.20	-	-	1,361.20	1,150.60	1,361.20	1,054.60	1,054.60	1,054.60	1,054.60	1,054.60
7237F Fire Rated 3/4" Offset	7237F SET	1750	1	1,046.70	-	1,046.70	-	-	1,046.70	1,008.30	1,046.70	914.60	914.60	914.60	914.60	914.60
	7237F TOP	-	1	437.90	-	437.90	-	-	437.90	410.90	437.90	354.10	354.10	354.10	354.10	354.10
	7237F BTM	1750	1	723.80	-	723.80	-	-	723.80	704.00	723.80	657.20	657.20	657.20	657.20	657.20
	7237F INT	100	1	476.30	-	476.30	-	-	476.30	457.90	476.30	392.60	392.60	392.60	392.60	392.60
	7237FPT INT TW4			1,194.80	-	1,194.80	-	-	1,194.80	984.20	1,194.80	888.20	888.20	888.20	888.20	888.20
	7237FPT INT TW8			1,361.20	-	1,361.20	-	-	1,361.20	1,150.60	1,361.20	1,054.60	1,054.60	1,054.60	1,054.60	1,054.60
7244F Fire Rated 1-1/2" Offset Pivot	7244F SET	400	1	886.10	-	886.10	-	-	886.10	856.20	886.10	740.70	740.70	740.70	740.70	740.70
	7244F TOP	-	1	476.30	-	476.30	-	-	476.30	448.00	476.30	410.90	410.90	410.90	410.90	410.90
	7244F BTM	400	1	514.80	-	514.80	-	-	514.80	486.40	514.80	418.20	418.20	418.20	418.20	418.20
	7244F INT	100	1	514.80	-	514.80	-	-	514.80	486.40	514.80	429.40	429.40	429.40	429.40	429.40

Lead time exception: The following Pivots are stocked.

7215 Set US26D, 7226 Set US26D, 7230F Set US32D, 7253 Set US26D, 7255 Set US26D, 7215-7226-7227 INT US26D

Non-Stocked PT INT pivots may take up to 4-5 weeks for shipment.

Contact Ives Customer Service for pricing on additional sizes and finishes

Bold pricing indicates item is in stock and available for **Fast Track** and **ProXpress**

HINGES

CONTINUOUS HINGES

PIVOTS

Numerical 1-059

Numerical 59-437

Numerical 438-1021

Numerical 1152-8190

Numerical 8200-9266

Pivots

MODEL	PART DESCRIPTION	POUND BOX RATING	QTY	US3	US4	US10	US15	US10B	US26 *US32	US26D *US32D	643e 716	SP28	SP10	BLK	SP313	SP4	USP
7245F Fire Rated 1-1/2" Offset Pivot	7245FSET	500	1	1,142.00	-	1,142.00	-	-	1,142.00	1,103.80	1,142.00	1,008.30	1,008.30	1,008.30	1,008.30	1,008.30	-
	7245F TOP	-	1	476.30	-	476.30	-	-	476.30	448.00	476.30	410.90	410.90	410.90	410.90	410.90	-
	7245FBTM	500	1	800.60	-	800.60	-	-	800.60	780.90	800.60	704.00	704.00	704.00	704.00	704.00	-
	7245FINT	100	1	514.80	-	514.80	-	-	514.80	486.40	514.80	429.40	429.40	429.40	429.40	429.40	-
7253 1-1/2" Pivot Center Hung	7253SET	300	1	362.50	362.50	362.50	362.50	362.50	362.50	362.50	362.50	315.60	315.60	315.60	315.60	315.60	-
	7253 TOP	-	1	220.40	220.40	220.40	220.40	220.40	220.40	220.40	220.40	200.60	200.60	200.60	200.60	200.60	-
	7253 BTM	300	1	200.60	200.60	200.60	200.60	200.60	200.60	173.50	200.60	145.20	145.20	145.20	145.20	145.20	-
7255 1-1/2" Pivot Center Hung	7255SET	500	1	399.70	399.70	399.70	399.70	399.70	399.70	399.70	399.70	372.60	372.60	372.60	372.60	372.60	-
	7255 TOP	-	1	220.40	220.40	220.40	220.40	220.40	220.40	220.40	220.40	200.60	200.60	200.60	200.60	200.60	-
	7255 BTM	500	1	228.90	228.90	228.90	228.90	228.90	228.90	228.90	228.90	220.40	220.40	220.40	220.40	220.40	-
7255J 1-1/2" Pivot Center Hung	7255JSET	600	1	399.70	399.70	399.70	399.70	399.70	399.70	399.70	399.70	372.60	372.60	372.60	372.60	372.60	-
	7255J TOP	-	1	220.40	220.40	220.40	220.40	220.40	220.40	220.40	220.40	200.60	200.60	200.60	200.60	200.60	-
	7255J BTM	500	1	228.90	228.90	228.90	228.90	228.90	228.90	228.90	228.90	220.40	220.40	220.40	220.40	220.40	-
7256 1-1/2" Pivot Center Hung	7256SET	600	1	667.00	667.00	667.00	667.00	667.00	667.00	628.80	667.00	600.30	600.30	600.30	600.30	600.30	-
	7256 TOP	-	1	220.40	220.40	220.40	220.40	220.40	220.40	220.40	220.40	200.60	200.60	200.60	200.60	200.60	-
	7256 BTM	600	1	544.90	544.90	544.90	544.90	544.90	544.90	514.80	544.90	486.40	486.40	486.40	486.40	486.40	-
7259 1-1/2" Pivot Center Hung	7259SET	1000	1	1,198.80	1,198.80	1,198.80	1,198.80	1,198.80	1,198.80	1,159.10	1,198.80	1,122.00	1,122.00	1,122.00	1,122.00	1,122.00	-
	7259 TOP	-	1	467.90	467.90	467.90	467.90	467.90	467.90	399.70	467.90	334.30	334.30	334.30	334.30	334.30	-
	7259 BTM	1000	1	989.90	989.90	989.90	989.90	989.90	989.90	951.40	989.90	922.90	922.90	922.90	922.90	922.90	-
91105F Pocket Pivot E = Power Transfer	91105F	90	1	540.10	-	540.10	540.10	540.10	540.10	490.00	540.10	-	-	-	490.00	-	490.00
	E91105F TW4	90	1	1,258.90	-	1,258.90	-	-	1,258.90	1,207.90	1,258.90	-	-	-	1,207.90	-	1,207.90
	E91105F TW8	90	1	1,425.30	-	1,425.30	-	-	1,425.30	1,374.30	1,425.30	-	-	-	1,374.30	-	1,374.30

Lead time exception: The following Pivots are stocked.

7215 Set US26D, 7226 Set US26D, 7230F Set US32D, 7253 Set US26D, 7255 Set US26D, 7215-7226-7227 INT US26D

Non-Stocked E91105F pivots may take up to 4-5 weeks for shipment.

* Fire rated models US32 and US32D (stainless), all others US26 and US26D (brass)

Suffix Descriptions

BTM - Bottom Only

F - Fire Rated

INT - Intermediate Pivot Only

PT - Power Transfer, TW4 standard, TW* consult Factory for lead time.

SET - Top and Bottom Pivot



TOP - Top Only

V - Vertical Side Mount

(Weather Resistant) WP bearings available for 7215 26D and 7215F 32D bottom pivots at \$80 list add. Consult factory for lead time.

Edge Guards

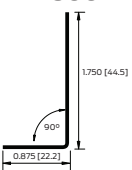
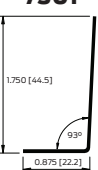
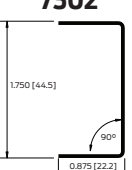
Completed order form required with each PO. Order form and brochure available on us.allegion.com
Length: 1/8" Increments, Min = 12", Max = 120"

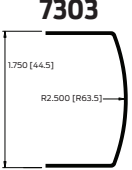
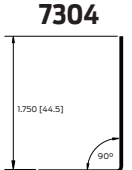
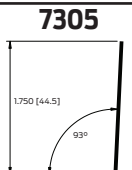
Model	Style	Size	US32D/630	US32/629	US32D-AM/ 630-AM	US3/605	US4/606	US10/612	US10B/613	US28/628
			Satin Stainless	Buff Stainless	Satin Stainless-AM	Buff Brass	Satin Brass	Satin Bronze	Oil Rubbed Bronze	Clear Anodized Aluminum
7300 	Mortise	Up to 42"	57.00	80.00	103.00	103.00	103.00	129.00	129.00	54.00
		Up to 96"	114.00	160.00	206.00	206.00	206.00	258.00	258.00	109.00
		Up to 120"	146.00	204.00	262.00	262.00	262.00	328.00	328.00	138.00
7301 	Mortise, beveled	Up to 42"	57.00	80.00	103.00	103.00	103.00	129.00	129.00	54.00
		Up to 96"	114.00	160.00	206.00	206.00	206.00	258.00	258.00	109.00
		Up to 120"	146.00	204.00	262.00	262.00	262.00	328.00	328.00	138.00
7302 	Mortise, wrap	Up to 42"	82.00	114.00	148.00	148.00	148.00	185.00	185.00	78.00
		Up to 96"	156.00	218.00	281.00	281.00	281.00	352.00	352.00	149.00
		Up to 120"	198.00	277.00	356.00	356.00	356.00	445.00	445.00	188.00
7302B 	Mortise, wrap beveled	Up to 42"	82.00	114.00	148.00	148.00	148.00	185.00	185.00	78.00
		Up to 96"	156.00	218.00	281.00	281.00	281.00	352.00	352.00	149.00
		Up to 120"	198.00	277.00	356.00	356.00	356.00	445.00	445.00	188.00
7303 	Mortise, bull	Up to 42"	106.00	106.00	191.00	191.00	191.00	239.00	239.00	101.00
		Up to 96"	198.00	198.00	356.00	356.00	356.00	445.00	445.00	188.00
		Up to 120"	250.00	250.00	449.00	449.00	449.00	562.00	562.00	237.00
7304 	Non-mortise	Up to 42"	57.00	80.00	103.00	103.00	103.00	129.00	129.00	54.00
		Up to 96"	114.00	160.00	206.00	206.00	206.00	258.00	258.00	109.00
		Up to 120"	146.00	204.00	262.00	262.00	262.00	328.00	328.00	138.00
7305 	Non-mortise, beveled	Up to 42"	57.00	80.00	103.00	103.00	103.00	129.00	129.00	54.00
		Up to 96"	114.00	160.00	206.00	206.00	206.00	258.00	258.00	109.00
		Up to 120"	146.00	204.00	262.00	262.00	262.00	328.00	328.00	138.00

HINGES
 CONTINUOUS HINGES
 PIVOTS
 Numerical 1-059
 Numerical 59-437
 Numerical 438-1021
 Numerical 1152-8190
 Numerical 8200-9266

Contact Ives Customer Service for pricing on additional sizes and finishes

Bold pricing indicates item is in stock and available for **Fast Track** and **ProXpress**

Edge Guards

Completed order form required with each PO. Order form and brochure available on us.allegion.com
 Length: 1/8" Increments, Min = 12", Max = 120"

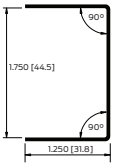
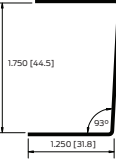
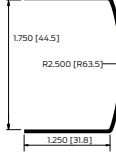
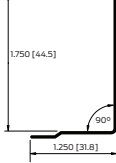
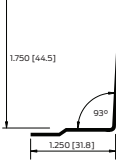
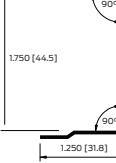
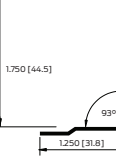
Model	Style	Size	US32D/630	US32/629	US32D-AM/ 630-AM	US3/605	US4/606	US10/612	US10B/613	US28/628
			Satin Stainless	Buff Stainless	Satin Stainless-AM	Buff Brass	Satin Brass	Satin Bronze	Oil Rubbed Bronze	Clear Anodized Aluminum
7306 	Non-mortise, wrap	Up to 42"	82.00	114.00	148.00	148.00	148.00	185.00	185.00	78.00
		Up to 96"	156.00	218.00	281.00	281.00	281.00	352.00	352.00	149.00
		Up to 120"	198.00	277.00	356.00	356.00	356.00	445.00	445.00	188.00
7306B 	Non-mortise, wrap beveled	Up to 42"	82.00	114.00	148.00	148.00	148.00	185.00	185.00	78.00
		Up to 96"	156.00	218.00	281.00	281.00	281.00	352.00	352.00	149.00
		Up to 120"	198.00	277.00	356.00	356.00	356.00	445.00	445.00	188.00
7307 	Non-mortise, bull	Up to 42"	106.00	149.00	191.00	191.00	191.00	239.00	239.00	101.00
		Up to 96"	198.00	277.00	356.00	356.00	356.00	445.00	445.00	188.00
		Up to 120"	250.00	349.00	449.00	449.00	449.00	562.00	562.00	237.00
7308 	Overlap	Up to 42"	78.00	109.00	140.00	140.00	140.00	176.00	176.00	74.00
		Up to 96"	135.00	189.00	243.00	243.00	243.00	305.00	305.00	129.00
		Up to 120"	172.00	240.00	309.00	309.00	309.00	386.00	386.00	163.00
7309 	Overlap, beveled	Up to 42"	78.00	109.00	140.00	140.00	140.00	176.00	176.00	74.00
		Up to 96"	135.00	189.00	243.00	243.00	243.00	305.00	305.00	129.00
		Up to 120"	172.00	240.00	309.00	309.00	309.00	386.00	386.00	163.00
7310 	Overlap, wrap	Up to 42"	108.00	152.00	194.00	194.00	194.00	243.00	243.00	103.00
		Up to 96"	177.00	248.00	318.00	318.00	318.00	398.00	398.00	168.00
		Up to 120"	224.00	313.00	402.00	402.00	402.00	503.00	503.00	212.00
7310B 	Overlap, wrap beveled	Up to 42"	108.00	152.00	194.00	194.00	194.00	243.00	243.00	103.00
		Up to 96"	177.00	248.00	318.00	318.00	318.00	398.00	398.00	168.00
		Up to 120"	224.00	313.00	402.00	402.00	402.00	503.00	503.00	212.00

Contact Ives Customer Service for pricing on additional sizes and finishes

Bold pricing indicates item is in stock and available for **Fast Track** and **ProXpress**

Edge Guards

Completed order form required with each PO. Order form and brochure available on us.allegion.com

Length: 1/8" Increments, Min = 12", Max = 120"

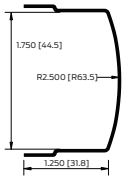
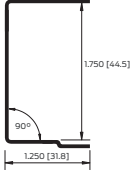
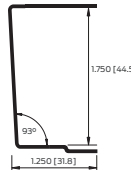
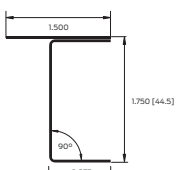
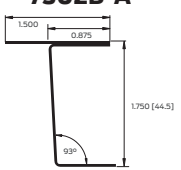
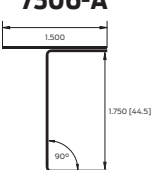
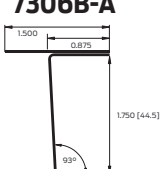
Model	Style	Size	US32D/630	US32/629	US32D-AM/ 630-AM	US3/605	US4/606	US10/612	US10B/613	US28/628
			Satin Stainless	Buff Stainless	Satin Stainless-AM	Buff Brass	Satin Brass	Satin Bronze	Oil Rubbed Bronze	Clear Anodized Aluminum
7311 	Overlap, bull	Up to 42"	114.00	160.00	206.00	206.00	206.00	258.00	258.00	109.00
		Up to 96"	208.00	291.00	374.00	374.00	374.00	468.00	468.00	198.00
		Up to 120"	260.00	364.00	468.00	468.00	468.00	586.00	586.00	248.00
7310S 	Semi-Overlap, wrap	Up to 42"	114.00	160.00	206.00	206.00	206.00	258.00	258.00	109.00
		Up to 96"	208.00	291.00	374.00	374.00	374.00	468.00	468.00	198.00
		Up to 120"	260.00	364.00	468.00	468.00	468.00	586.00	586.00	248.00
7310SB 	Semi-overlap, wrap beveled	Up to 42"	114.00	160.00	206.00	206.00	206.00	258.00	258.00	109.00
		Up to 96"	208.00	291.00	374.00	374.00	374.00	468.00	468.00	198.00
		Up to 120"	260.00	364.00	468.00	468.00	468.00	586.00	586.00	248.00
7302-A 	Mortise, astragal	Up to 42"	108.00							
		Up to 96"	177.00							
		Up to 120"	224.00							
7302B-A 	Mortise, astragal beveled	Up to 42"	108.00							
		Up to 96"	177.00							
		Up to 120"	224.00							
7306-A 	Non-mortise, astragal	Up to 42"	108.00							
		Up to 96"	177.00							
		Up to 120"	224.00							
7306B-A 	Non-mortise, astragal beveled	Up to 42"	108.00							
		Up to 96"	177.00							
		Up to 120"	224.00							

HINGES
 CONTINUOUS HINGES
 PIVOTS
 Numerical 1-059
 Numerical 59-437
 Numerical 438-1021
 Numerical 1152-8190
 Numerical 8200-9266

Contact Ives Customer Service for pricing on additional sizes and finishes

Bold pricing indicates item is in stock and available for **Fast Track** and **ProXpress**

Edge Guards

Completed order form required with each PO. Order form and brochure available on us.allegion.com

Length: 1/8" Increments, Min = 12", Max = 120"

Edge Guard Options

UL Rating:	\$15.00
TEK/TORX (TK/TX) Screws:	\$14.00
Each Cutout:	\$23.00
Handing options:	LH, RH, LHR, RHR
Door Type:	Active/Inactive (required for astragal models)
Door Thickness:	1 3/4" Standard, Optional 2" or 2 1/4"

Cutout Options

Up to three cutouts allowed on standard orders

1-1/8" x 2-3/4"	No. 1 cylinder strike
1-1/4" x 4-7/8	No. 2 ASA strike
1" x 6-3/4"	No. 3 auto and constant latch flush bolt
1" x 8-1/2"	No. 4 constant latch flush bolt-wood doors
1-1/4" x 8"	No. 5 mortise lock
1-1/8" x 2-1/4"	No. 6 latch bolt
1 x 4-1/2"	No. 7 hinge
1" x 5"	No. 8 hinge
1" diameter	No. 9 auxiliary fire latch inactive
1" x 1-49/64"	No. 10 auxiliary fire latch active

HINGES

CONTINUOUS
HINGES

PIVOTS

Numerical
1-059

Numerical
59-437







Numerical
438-1021

Numerical
1152-8190

Numerical
8200-9266

Contact Ives Customer Service for pricing on additional sizes and finishes

Bold pricing indicates item is in stock and available for **Fast Track** and **ProXpress**







MODEL	SUBSTRATE	MODEL NUMBER	BHMA FINISH	WEIGHT	MUST BE ORDERED IN MULTIPLE QTY	MULTIPLE QTY	PACKED PER BOX	LIST PRICE	
								EACH	PACKAGE
CBI Carry Bar w/ Sex Bolts 	Steel	CBI USP	600	-	-	-	-	\$39.40	-
		CBI US3	632	-	-	-	-	60.30	-
		CBI US4	633	-	-	-	-	60.30	-
		CBI US10	639	-	-	-	-	60.30	-
		CBI US10B	640	-	-	-	-	60.30	-
		CBI US26	651	-	-	-	-	60.30	-
		CBI US26D	652	-	-	-	-	60.30	-
		CBI BLK	-	-	-	-	-	39.40	-
DPI Dust Proof Strike Threshold Only 	Brass	DPI US3	605	-	-	1	-	31.40	-
		DPI US4	606	-	-	1	-	31.40	-
		DPI US10	612	-	-	1	-	31.40	-
		DPI US10B **	613	-	-	1	-	31.40	-
		DPI US26	625	-	-	1	-	31.40	-
		DPI US26D **	626	-	-	1	-	31.40	-
LG1 Lock Guard with Security Pin Frame 	Steel	LG1 USP	600	-	-	1	-	26.40	-
		LG1 US2G	603	-	-	1	-	21.60	-
		LG1 SP313	695	-	-	1	-	25.00	-
	Brass	LG1 US4	606	-	-	1	-	55.00	-
		LG1 US10	612	-	-	1	-	55.00	-
Stainless	LG1 US32D**	630	-	-	1	-	50.00	-	
MB1 Mounting Bracket	See Page 36								
DP2 Dust Proof Strike Floor and /or Threshold 	Brass	DP2 US3 **	605	-	-	1	-	39.50	-
		DP2 US4**	606	-	-	1	-	39.50	-
		DP2 US10**	612	-	-	1	-	39.50	-
		DP2 US10B **	613	-	-	1	-	39.50	-
		DP2 US15 **	619	-	-	1	-	39.50	-
		DP2 US26 **	625	-	-	1	-	39.50	-
		DP2 US26D **	626	-	-	1	-	39.50	-
		DP2 643E/716	-	-	-	1	-	39.50	-
DP2 BLK**	622	-	-	1	-	39.50	-		
MB2 Mounting Bracket	See Page 36								
2 Elbow Cabinet Catch 	Aluminum	2A3**	666	0.9	-	1	20	4.60	-
		2A5	-	0.9	-	1	20	5.10	-
		2A14**	669	0.9	-	1	20	5.10	-
		2A15	670	0.9	-	1	20	5.10	-
		2A26	672	0.9	-	1	20	5.10	-
		2A26D	702	0.9	-	1	20	5.10	-
		2A92**	673	0.9	-	1	20	4.60	-
		2A-643E/716**	-	0.9	-	1	20	5.10	-
		2A-BLK	-	0.9	-	1	20	5.10	-
		SP2A3**	666	37.5	Yes	25	25	-	\$114.75
		SP2A14	669	37.5	Yes	25	25	-	126.00
SP2A92**	673	37.5	Yes	25	25	-	114.75		
MB3 Mounting Bracket	See Page 36								
LG7 Lock Guard	Stainless	LG7 US32D	630	-	-	1	-	50.00	-
COR7G Coordinator Gravity Arm 7" arm UL Listed 	Brass	COR7G US3	605	-	-	1	-	99.00	-
		COR7G US4	606	-	-	1	-	99.00	-
		COR7G US10	612	-	-	1	-	99.00	-
		COR7G US10B	613	-	-	1	-	99.00	-
		COR7G US26	625	-	-	1	-	133.50	-
		COR7G US26D**	626	-	-	1	-	82.30	-

HINGES
 CONTINUOUS HINGES
 PIVOTS
 Numerical 1-059
 Numerical 59-437
 Numerical 438-1021
 Numerical 1152-8190
 Numerical 8200-9266

Lead time exception: ** Products are stocked and will typically ship within 3 days













Bold pricing indicates item is in stock and available for **Fast Track** and **ProXpress**

HINGES
 CONTINUOUS HINGES
 PIVOTS
 Numerical 1-059
 Numerical 59-437
 Numerical 438-1021
 Numerical 1152-8190
 Numerical 8200-9266

MODEL	SUBSTRATE	MODEL NUMBER	BHMA FINISH	WEIGHT	MUST BE ORDERED IN MULTIPLE QTY	MULTIPLE QTY	PACKED PER BOX	LIST PRICE		
								EACH	PACKAGE	
07 Window Lock 	Aluminum	07A3**	666	1.7	-	1	20	\$3.10	-	
		07A10B**	703	1.7	-	-	1	20	3.40	-
		07A14	669	1.7	-	-	1	20	3.40	-
		07A15	670	1.7	-	-	1	20	3.40	-
		07A26	672	1.7	-	-	1	20	3.40	-
		07A26D	702	1.7	-	-	1	20	3.40	-
		07A92	673	1.7	-	-	1	20	3.10	-
		07A-643E/716	-	1.7	-	-	1	20	3.40	-
		07A-BLK**	-	1.7	-	-	1	20	4.60	-
		07A-W	-	1.7	-	-	1	20	4.60	-
		SP07A3	666	65	Yes	25	25	25	-	77.50
		SP07A5	-	65	Yes	25	25	25	-	114.75
		SP07A14	669	65	Yes	25	25	25	-	86.00
		SP07A92	673	65	Yes	25	25	25	-	77.50
		SP07A-W	-	52	Yes	20	20	20	-	91.80
COR9G Coordinator Gravity Arm 9" arm UL Listed	Brass	COR9G US3	605	-	-	1	-	111.90	-	
		COR9G US4	606	-	-	1	-	111.90	-	
		COR9G US10	612	-	-	1	-	111.90	-	
		COR9G US10B	613	-	-	1	-	111.90	-	
		COR9G US26	625	-	-	1	-	133.50	-	
		COR9G US26D	626	-	-	1	-	94.30	-	
FS9 Floor Stop 	Brass	FS9 US3	605	-	-	1	-	226.10	-	
		FS9 US4	606	-	-	1	-	226.10	-	
		FS9 US10	612	-	-	1	-	226.10	-	
		FS9 US10B	613	-	-	1	-	226.10	-	
		FS9 US26	625	-	-	1	-	226.10	-	
		FS9 US26D	626	-	-	1	-	193.80	-	
LG10 Lock Guard 	Stainless	LG10 US32D**	630	-	-	1	-	46.60	-	
	Steel	LG10 USP	600	-	-	1	-	31.70	-	
CL11 Cabinet Latch 	Brass	CL11 US3	605	-	-	1	-	50.90	-	
		CL11 US4	606	-	-	1	-	40.10	-	
		CL11 US10	612	-	-	1	-	40.10	-	
		CL11 US26D**	626	-	-	1	-	40.10	-	
LG11 Lock Guard 	Stainless	LG11 US32D RH	630	-	-	1	-	55.00	-	
		LG11 US32D LH	630	-	-	1	-	55.00	-	
	Steel	LG11 SP313 RH	695	-	-	1	-	41.60	-	
		LG11 SP313 LH	695	-	-	1	-	41.60	-	
WS11 Wall Stop for Drywall Mounting 	Brass	WS11 US3	605	-	-	1	-	50.30	-	
		WS11 US4	606	-	-	1	-	50.30	-	
		WS11 US10	612	-	-	1	-	50.30	-	
		WS11 US10B	613	-	-	1	-	50.30	-	
		WS11 US26	625	-	-	1	-	50.30	-	
		WS11 US26D**	626	-	-	1	-	49.00	-	

Lead time exception: ** Products are stocked and will typically ship within 3 days

Bold pricing indicates item is in stock and available for **Fast Track** and **ProXpress**





MODEL	SUBSTRATE	MODEL NUMBER	BHMA FINISH	WEIGHT	MUST BE ORDERED IN MULTIPLE QTY	MULTIPLE QTY	PACKED PER BOX	LIST PRICE	
								EACH	PACKAGE
WS11X Wall Stop for Masonry Mounting 	Brass	WS11X US3	605	-	-	1	-	\$53.70	-
		WS11X US4	606	-	-	1	-	53.70	-
		WS11X US10	612	-	-	1	-	53.70	-
		WS11X US10B	613	-	-	1	-	53.70	-
		WS11X US26	625	-	-	1	-	53.70	-
		WS11X US26D	626	-	-	1	-	52.00	-
CL12 Cabinet Latch 	Brass	CL12 US3	605	-	-	1	-	55.20	-
		CL12 US4**	606	-	-	1	-	48.90	-
		CL12 US10**	612	-	-	1	-	48.90	-
		CL12 US26D **	626	-	-	1	-	48.90	-
LG12 Lock Guard - Narrow 	Stainless	LG12 US32D **	630	-	-	1	-	43.30	-
	Steel	LG12 USP	600	-	-	1	-	31.70	-
FS13 Floor Dome Stop 1" height 	Brass	FS13 US3	605	-	-	1	-	9.20	-
		FS13 US4	606	-	-	1	-	10.80	-
		FS13 US10	612	-	-	1	-	10.90	-
		FS13 US10B **	613	-	-	1	-	10.90	-
		FS13 US26	625	-	-	1	-	10.80	-
		FS13 US26D **	626	-	-	1	-	9.20	-
LG13 Lock Guard 	Stainless	LG13 US32D **	630	-	-	1	-	41.60	-
	Steel	LG13 USP	600	-	-	1	-	27.50	-
CL14 Cabinet Latch 	Brass	CL14 US3	605	-	-	1	-	50.60	-
		CL14 US4	606	-	-	1	-	42.50	-
		CL14 US10	612	-	-	1	-	42.50	-
		CL14 US26D	626	-	-	1	-	42.50	-
LG14 Lock Guard 	Stainless	LG14 US32D **	630	-	-	1	-	68.30	-
FS17 Floor Dome Stop 1-11/32" height 	Brass	FS17 US3	605	-	-	1	-	10.10	-
		FS17 US4	606	-	-	1	-	12.20	-
		FS17 US10	612	-	-	1	-	12.60	-
		FS17 US10B**	613	-	-	1	-	12.60	-
		FS17 US26	625	-	-	1	-	12.20	-
		FS17 US26D **	626	-	-	1	-	10.10	-
R14 Riser For FS13 and FS17 Dome Stops 5/16" Height 	Steel	R14 US3	605	-	-	1	-	7.70	-
		R14 US4	606	-	-	1	-	7.70	-
		R14 US10	612	-	-	1	-	8.50	-
		R14 US10B	613	-	-	1	-	8.50	-
		R14 US26	625	-	-	1	-	8.50	-
		R14 US26D **	626	-	-	1	-	10.00	-
AS18 Applied Stop 	Brass	AS18 US3	605	-	-	1	-	58.40	-
		AS18 US4	606	-	-	1	-	53.80	-
		AS18 US10	612	-	-	1	-	53.80	-
		AS18 US10B	613	-	-	1	-	58.40	-
		AS18 US26	625	-	-	1	-	58.40	-
		AS18 US26D	626	-	-	1	-	58.40	-
FS18 Security Floor or Wall Stop 	Steel/	FS18S **	-	-	-	1	-	13.40	-
	Rubber	FS18L **	-	-	-	1	-	18.90	-
FL20 Filler Bar 	See page 32								
WS20 Manual Wall Stop and Holder for Drywall Mounting 	Brass	WS20 US3	605	-	-	1	-	91.10	-
		WS20 US4	606	-	-	1	-	91.10	-
		WS20 US10	612	-	-	1	-	91.10	-
		WS20 US10B	613	-	-	1	-	91.10	-
		WS20 US26	625	-	-	1	-	91.10	-
		WS20 US26D **	626	-	-	1	-	76.40	-
	Aluminum	WS20 US28	628	-	-	1	-	72.90	-

Lead time exception: ** Products are stocked and will typically ship within 3 days

Bold pricing indicates item is in stock and available for **Fast Track** and **ProXpress**

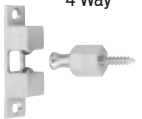
HINGES
 CONTINUOUS HINGES
 PIVOTS
 Numerical 1-059
 Numerical 59-437
 Numerical 438-1021
 Numerical 1152-8190
 Numerical 8200-9266





HINGES
 CONTINUOUS HINGES
 PIVOTS
 Numerical 1-059
 Numerical 59-437
 Numerical 438-1021
 Numerical 1152-8190
 Numerical 8200-9266

MODEL	SUBSTRATE	MODEL NUMBER	BHMA FINISH	WEIGHT	MUST BE ORDERED IN MULTIPLE QTY	MULTIPLE QTY	PACKED PER BOX	LIST PRICE	
								EACH	PACKAGE
WS20X Manual Wall Stop and Holder for Masonry Mounting 	Brass	WS20X US3	605	-	-	1	-	\$94.20	-
		WS20X US4	606	-	-	1	-	94.20	-
		WS20X US10	612	-	-	1	-	94.20	-
		WS20X US10B	613	-	-	1	-	94.20	-
		WS20X US26	625	-	-	1	-	94.20	-
		WS20X US26D	626	-	-	1	-	81.40	-
	Aluminum	WS20X US28	628	-	-	1	-	77.50	-
CL21/21A Ball Catch 4 Way 	Brass	CL21 US26D	626	-	-	1	-	50.50	-
		CL21A US3	605	-	-	1	-	53.80	-
		CL21A US4	606	-	-	1	-	36.30	-
		CL21A US10	612	-	-	1	-	36.30	-
		CL21A US26	625	-	-	1	-	53.80	-
		CL21A US26D**	626	-	-	1	-	39.50	-
CL22 Ball Catch 3 Way 	Brass	CL22 US3	605	-	-	1	-	31.60	-
		CL22 US4	606	-	-	1	-	22.20	-
		CL22 US10	612	-	-	1	-	22.20	-
		CL22 US26	625	-	-	1	-	31.60	-
		CL22 US26D	626	-	-	1	-	26.60	-
22 Flush Pull 	Brass	22B3	605	1.1	-	1	20	3.70	-
		22B5	609	2.0	-	1	20	4.30	-
		22B10B**	613	1.3	-	1	20	4.30	-
		22B15**	619	1.6	-	1	20	4.20	-
		22B26**	625	1.6	-	1	20	4.30	-
		22B26D**	626	1.1	-	1	20	4.30	-
		22B643E/716	-	1.1	-	1	20	4.30	-
		22B-BLK	622	1.1	-	1	20	4.30	-
		SP22B3	605	50.0	Yes	25	25	-	93.00
25 Screen Door Pull 	Aluminum	25A3	666	1.2	-	1	20	2.20	-
		25A92	673	1.2	-	1	20	2.20	-
		25A-BLK	-	1.2	-	1	20	3.10	-
		25A-W	-	1.2	-	1	20	3.10	-
		SP25A3	666	30.0	Yes	25	25	-	53.25
		SP25A92	673	30.0	Yes	25	25	-	53.25
026 Bar Window Lift 	Aluminum	026A3	666	1.9	-	1	10	2.20	-
		026A5	-	1.1	-	1	10	2.80	-
		026A14	669	1.8	-	1	10	2.80	-
		026A15	670	1.9	-	1	10	2.80	-
		026A26	672	1.9	-	1	10	2.80	-
		026A26D	702	1.9	-	1	10	2.80	-
		026A92	673	1.1	-	1	10	2.20	-
		026A-643E/716	-	1.1	-	1	10	2.80	-
		026A-BLK	-	1.4	-	1	10	3.30	-
		026A-W	-	1.4	-	1	10	3.30	-
		SP026A3	666	45.0	Yes	25	25	-	54.25
		SP026A5	-	45.0	Yes	25	25	-	69.00
		SP026A14	669	45.0	Yes	25	25	-	69.00
		SP026A92	673	45.0	Yes	25	25	-	54.25
		SP026A-W	-	-	Yes	20	20	-	66.40

Continued on next page.

Lead time exception: ** Products are stocked and will typically ship within 3 days

Bold pricing indicates item is in stock and available for **Fast Track** and **ProXpress**

MODEL	SUBSTRATE	MODEL NUMBER	BHMA FINISH	WEIGHT	MUST BE ORDERED IN MULTIPLE QTY	MULTIPLE QTY	PACKED PER BOX	LIST PRICE	
								EACH	PACKAGE
<i>Continued from previous page.</i> 026 Bar Window Lift 	Brass	026B3**	605	-	-	1	10	\$9.80	
		026B5	609	-	-	1	10	11.80	
		026B15	619	-	-	1	10	12.00	
		026B26	625	-	-	1	10	12.00	
		026B26D	626	-	-	1	10	11.80	
		026B-643E/716**	-	-	-	1	10	12.00	
		026B-BLK	622	-	-	1	10	12.00	
		SPO26B26	625	-	-	Yes	10	10	-
RL30 Nylon Roller 	Brass	RL30 US3	605	-	-	1	-	82.60	-
		RL30 US4	606	-	-	1	-	70.30	-
		RL30 US10	612	-	-	1	-	73.10	-
		RL30 US10B **	613	-	-	1	-	85.60	-
		RL30 US15	619	-	-	1	-	82.60	-
		RL30 US26	625	-	-	1	-	82.60	-
		RL30 US26D **	626	-	-	1	-	78.10	-
		RL30 643E/716	-	-	-	1	-	85.60	-
RL30 BLK**	622	-	-	1	-	78.10	-		
RL30A Nylon Roller w/ASA Strike 	Brass	RL30-A US3	605	-	-	1	-	92.50	-
		RL30-A US4	606	-	-	1	-	80.20	-
		RL30-A US10	612	-	-	1	-	83.40	-
		RL30-A US10B	613	-	-	1	-	95.90	-
		RL30-A US26	625	-	-	1	-	92.50	-
		RL30-A US26D	626	-	-	1	-	88.10	-
FB31 Automatic Flush Bolts, Metal Doors UL 3 Hour Top and Bottom Bolt P=Pair T=Top Bolt Only B=Bottom Bolt Only Optional Rod Lengths Available 18", 24", 36", 48" 13.50 List Add 	Steel	FB31P-12-MD US3	605	-	-	1	-	222.20	-
		FB31P-12-MD US4	606	-	-	1	-	222.20	-
		FB31P-12-MD US10	612	-	-	1	-	222.20	-
		FB31P-12-MD US10B	613	-	-	1	-	222.20	-
	Stainless	FB31P-12-MD US32	629	-	-	1	-	222.20	-
		FB31P-12-MD US32D **	630	-	-	1	-	222.20	-
		FB31P-12-MD BLK	-	-	-	1	-	222.20	-
	Brass	FB31T-12-MD US3	605	-	-	1	-	117.30	-
		FB31T-12-MD US4	606	-	-	1	-	117.30	-
		FB31T-12-MD US10	612	-	-	1	-	117.30	-
		FB31T-12-MD US10B	613	-	-	1	-	117.30	-
	Stainless	FB31T-12-MD US32	629	-	-	1	-	117.30	-
		FB31T-12-MD US32D **	630	-	-	1	-	117.30	-
		FB31T-12-MD BLK	-	-	-	1	-	117.30	-
	Brass	FB31B-12-MD US3	605	-	-	1	-	117.30	-
		FB31B-12-MD US4	606	-	-	1	-	117.30	-
		FB31B12-MD US10	612	-	-	1	-	117.30	-
		FB31B-12-MD US10B	613	-	-	1	-	117.30	-
Stainless	FB31B-12-MD US32	629	-	-	1	-	117.30	-	
	FB31B-12-MD US32D	630	-	-	1	-	117.30	-	
	FB31B-12-MD BLK	-	-	-	1	-	117.30	-	
COR32* Door Coordinator 32" Channel Length UL Listed *See note at page bottom for door prep charges.	Aluminum	COR32 US28	628	-	-	1	-	174.10	-
		COR32 315AN	711	-	-	1	-	232.40	-
		COR32 US26D	713	-	-	1	-	344.40	-
		COR32 US28w/FL20	628	-	-	1	-	190.80	-
COR42* Door Coordinator 42" Channel Length UL Listed *See note at page bottom for door prep charges.	Aluminum	COR42 US28	628	-	-	1	-	187.30	-
		COR42 315AN	711	-	-	1	-	247.40	-
		COR42 US26D	713	-	-	1	-	366.20	-
		COR42 US28w/FL20**	628	-	-	1	-	204.00	-
		COR42 US28w/FL32	628	-	-	1	-	207.40	-
		COR42 US28w/FL44	628	-	-	1	-	212.40	-

* Special factory preparation for use with vertical rod exit devices available. **List Add \$149.00.**

Lead time exception: ** Products are stocked and will typically ship within 3 days

Bold pricing indicates item is in stock and available for Fast Track and ProXpress

HINGES

CONTINUOUS HINGES

PIVOTS

Numerical 1-059

Numerical 59-437

Numerical 438-1021

Numerical 1152-8190

Numerical 8200-9266





HINGES
 CONTINUOUS HINGES
 PIVOTS
 Numerical 1-059
 Numerical 59-437
 Numerical 438-1021
 Numerical 1152-8190
 Numerical 8200-9266

MODEL	SUBSTRATE	MODEL NUMBER	BHMA FINISH	WEIGHT	MUST BE ORDERED IN MULTIPLE QTY	MULTIPLE QTY	PACKED PER BOX	LIST PRICE	
								EACH	PACKAGE
COR52* Door Coordinator 52" Channel Length UL Listed *See note at page bottom for door prep charges.	Aluminum	COR52 US28**	628	-	-	1	-	177.20	-
		COR52 315AN	711	-	-	1	-	230.40	-
		COR52 US26D	713	-	-	1	-	363.30	-
		COR52 US28w/FL20**	628	-	-	1	-	193.90	-
		COR52 US28w/FL32	628	-	-	1	-	197.30	-
		COR52 US28w/FL44	628	-	-	1	-	202.30	-
COR60* Door Coordinator 60" Channel Length UL Listed *See note at page bottom for door prep charges.	Aluminum	COR60 US28	628	-	-	1	-	206.80	-
		COR60 315AN	711	-	-	1	-	269.20	-
		COR60 US26D	713	-	-	1	-	391.10	-
		COR60 US28w/FL20**	628	-	-	1	-	223.50	-
		COR60 US28w/FL32**	628	-	-	1	-	226.90	-
		COR60 US28w/FL44	628	-	-	1	-	231.90	-
COR72* Door Coordinator 72" Channel Length UL Listed *See note at page bottom for door prep charges.	Aluminum	COR72 US28	628	-	-	1	-	235.20	-
		COR72 315AN	711	-	-	1	-	324.50	-
		COR72 US26D	713	-	-	1	-	467.90	-
		COR72 US28w/FL20	628	-	-	1	-	251.90	-
		COR72 US28w/FL32**	628	-	-	1	-	255.30	-
		COR72 US28w/FL44	628	-	-	1	-	260.30	-
FL20 Filler Bar 20" Length	Aluminum	FL20 US28**	628	-	-	1	-	16.70	-
		FL20 315AN	711	-	-	1	-	53.80	-
		FL20 US26D	713	-	-	1	-	78.70	-
FL32 Filler Bar 32" Length	Aluminum	FL32 US28	628	-	-	1	-	20.10	-
		FL32 315AN	711	-	-	1	-	56.90	-
		FL32 US26D	713	-	-	1	-	85.30	-
FL44 Filler Bar 44" Length	Aluminum	FL44 US28	628	-	-	1	-	25.10	-
		FL44 315AN	711	-	-	1	-	61.80	-
		FL44 US26D	713	-	-	1	-	100.30	-
MB1 Mounting Bracket Stop Widths Over 2-1/2"	Aluminum	MB1 USP**	600	-	-	1	-	24.00	-
		MB1 SP28**	689	-	-	1	-	34.20	-
		MB1 BLK**	-	-	-	1	-	34.20	-
MB1F & MB1V Mounting Bracket Stop Widths 1-1/2" - 2-1/4"	Steel	MB1F USP	600	-	-	1	-	61.80	-
		MB1F SP28	689	-	-	1	-	61.80	-
		MB1F BLK	-	-	-	1	-	61.80	-
		MB1V USP	600	-	-	1	-	98.30	-
		MB1V SP28	689	-	-	1	-	98.30	-
		MB1V BLK	-	-	-	1	-	98.30	-
MB2 Mounting Bracket Stop Widths Up to 2-1/2"	Aluminum	MB2 USP**	600	-	-	1	-	28.20	-
		MB2 SP28**	689	-	-	1	-	38.70	-
		MB2 BLK**	-	-	-	1	-	38.70	-
MB2F & MB2V Mounting Bracket Stop Widths 2-3/8" - 3-1/4"	Steel	MB2F USP	600	-	-	1	-	61.60	-
		MB2F SP28**	689	-	-	1	-	61.60	-
		MB2F BLK	-	-	-	1	-	61.60	-
		MB2V USP	600	-	-	1	-	98.40	-
		MB2V SP28	689	-	-	1	-	98.40	-
		MB2V BLK	-	-	-	1	-	98.40	-
MB3F & MB3V Mounting Bracket Stop Widths Over 3-3/8"	Steel	MB3F USP	600	-	-	1	-	61.60	-
		MB3F SP28	689	-	-	1	-	61.60	-
		MB3F BLK	-	-	-	1	-	61.60	-
		MB3V USP	600	-	-	1	-	98.40	-
		MB3V SP28	689	-	-	1	-	98.40	-
		MB3V BLK	-	-	-	1	-	98.40	-

* Special factory preparation for use with vertical rod exit devices available. List Add \$149.00.

Lead time exception: ** Products are stocked and will typically ship within 3 days

Bold pricing indicates item is in stock and available for **Fast Track** and **ProXpress**

MODEL	SUBSTRATE	MODEL NUMBER	BHMA FINISH	WEIGHT	MUST BE ORDERED IN MULTIPLE QTY	MULTIPLE QTY	PACKED PER BOX	LIST PRICE		
								EACH	PACKAGE	
FB32 Automatic Flush Bolts, Metal Doors UL 3 Hour Top Bolt w/Auxiliary Fire Latch 	Brass	FB32-12-MD US3	605	-	-	1	-	\$222.20	-	
		FB32-12-MD US4	606	-	-	1	-	222.20	-	
		FB32-12-MD US10	612	-	-	1	-	222.20	-	
		FB32-12-MD US10B	613	-	-	1	-	222.20	-	
	Stainless	FB32-12-MD US32	629	-	-	1	-	222.20	-	
		FB32-12-MD US32D**	630	-	-	1	-	222.20	-	
FB32-12-MD BLK	-	-	-	-	1	-	222.20	-		
COR32 Door Coordinator	See page 31									
FL32 Filler Bar	See page 32									
RL32 Nylon Roller 		RL32 US3	605	-	-	1	-	111.60	-	
		RL32 US4	606	-	-	1	-	105.50	-	
		RL32 US10	612	-	-	1	-	109.60	-	
		RL32 US10B**	613	-	-	1	-	116.00	-	
		RL32 US15	619	-	-	1	-	111.60	-	
		RL32 US26	625	-	-	1	-	111.60	-	
		RL32 US26D**	626	-	-	1	-	105.50	-	
		RL32 643E/716	-	-	-	-	1	-	116.00	-
		RL32 BLK**	-	-	-	-	1	-	111.60	-
RL32A Nylon Roller w/ASA Strike 	Brass	RL32-A US3	605	-	-	1	-	121.50	-	
		RL32-A US4	606	-	-	1	-	115.30	-	
		RL32-A US10	612	-	-	1	-	120.00	-	
		RL32-A US10B	613	-	-	1	-	126.30	-	
		RL32-A US26	625	-	-	1	-	121.50	-	
RL32-A US26D	626	-	-	1	-	115.30	-			
FB33 Top Auto Flush Bolt w/Auxiliary Fire Latch Retrofit Plate 	Brass	FB33-12-MD US3	605	-	-	1	-	229.50	-	
		FB33-12-MD US4	606	-	-	1	-	229.50	-	
		FB33-12-MD US10	612	-	-	1	-	229.50	-	
		FB33-12-MD US10B	613	-	-	1	-	229.50	-	
	Stainless	FB33-12-MD US32	629	-	-	1	-	229.50	-	
		FB33-12-MD US32D	630	-	-	1	-	229.50	-	
FB33-12-MD BLK	-	-	-	-	1	-	229.50	-		
WS33 Wall Stop For Drywall Mounting	Brass	WS33 US26D**	626	-	-	1	-	60.60	-	
WS33X Wall Stop For Masonary Mounting	Brass	WS33X US26D**	626	-	-	1	-	64.60	-	
RL36/36A Roller Latch Mortise	Stainless	RL36 US32D**	630	-	-	1	-	59.50	-	
		RL36-A US32D	630	-	-	1	-	69.90	-	
RL38 Roller Latch Surface Mount	Stainless	RL38 US32D**	630	-	-	1	-	56.20	-	
40 Decorative Light Duty Surface Bolt Packed with Universal and Mortise Strike 	Brass	40B3 3 IN	605	1.9	-	1	10	18.20	-	
		40B5 3 IN	609	1.9	-	1	10	18.20	-	
		40B10B 3 IN	613	1.9	-	1	10	19.00	-	
		40B15 3 IN	619	1.9	-	1	10	18.20	-	
		40B26 3 IN	625	1.9	-	1	10	19.00	-	
		40B26D 3 IN	626	1.9	-	1	10	19.00	-	
		40B643E/716 3 IN	-	1.9	-	1	10	19.00	-	
		40B-BLK 3 IN	622	1.9	-	1	10	19.00	-	
		40B3 4 IN	605	2.4	-	1	10	19.00	-	
		40B5 4 IN	609	2.4	-	1	10	19.10	-	
		40B10B 4 IN**	613	2.4	-	1	10	20.10	-	
		40B15 4 IN**	619	2.4	-	1	10	19.10	-	
		40B26 4 IN	625	2.4	-	1	10	20.10	-	
		40B26D 4 IN**	626	2.4	-	1	10	20.10	-	
40B643E/716 4 IN	-	2.4	-	1	10	20.10	-			
40B-BLK 4 IN	622	2.4	-	1	10	20.10	-			

Lead time exception: ** Products are stocked and will typically ship within 3 days

Bold pricing indicates item is in stock and available for **Fast Track** and **ProXpress**





HINGES
 CONTINUOUS HINGES
 PIVOTS
 Numerical 1-059
 Numerical 59-437
 Numerical 438-1021
 Numerical 1152-8190
 Numerical 8200-9266

HINGES

CONTINUOUS
HINGES





PIVOTS

Numerical
1-059Numerical
59-437Numerical
438-1021Numerical
1152-8190Numerical
8200-9266

MODEL	SUBSTRATE	MODEL NUMBER	BHMA FINISH	WEIGHT	MUST BE ORDERED IN MULTIPLE QTY	MULTIPLE QTY	PACKED PER BOX	LIST PRICE	
								EACH	PACKAGE
Continued from previous page. 40 Decorative Light Duty Surface Bolt Packed with Universal and Mortise Strike	Brass	40B3 6 IN**	605	3.5	-	1	10	\$22.50	-
		40B5 6 IN	609	3.5	-	1	10	22.50	-
		40B10B 6 IN**	613	3.5	-	1	10	23.40	-
		40B15 6 IN**	619	3.5	-	1	10	22.50	-
		40B26 6 IN	625	3.5	-	1	10	23.40	-
		40B26D 6 IN**	626	3.5	-	1	10	23.40	-
		40B643E/716 6 IN	-	3.5	-	1	10	23.40	-
FS40 Auto Floor Type Holder Floor Clearance 1/2" or less 	Brass	FS40 US3	605	-	-	1	-	95.50	-
		FS40 US4	606	-	-	1	-	71.30	-
		FS40 US10	612	-	-	1	-	95.50	-
		FS40 US10B	613	-	-	1	-	95.50	-
		FS40 US26	625	-	-	1	-	95.50	-
		FS40 US26D**	626	-	-	1	-	71.30	-
WS40 Automatic Wall Stop and Holder 	Brass	WS40 US3	605	-	-	1	-	128.00	-
		WS40 US4	606	-	-	1	-	128.00	-
		WS40 US10	612	-	-	1	-	128.00	-
		WS40 US10B	613	-	-	1	-	128.00	-
		WS40 US26	625	-	-	1	-	128.00	-
		WS40 US26D**	626	-	-	1	-	120.20	-
FB41 Automatic Flush Bolt Wood Door Top and Bottom Bolt UL Listed 90 Minutes P=Pair T=Top Bolt Only B=Bottom Bolt Only 	Brass	FB41P-WD US3	605	-	-	1	-	232.40	-
		FB41P-WD US4	606	-	-	1	-	232.40	-
		FB41P-WD US10	612	-	-	1	-	232.40	-
		FB41P-WD US10B	613	-	-	1	-	232.40	-
	Stainless	FB41P-WD US32	629	-	-	1	-	232.40	-
		FB41P-WD US32D**	630	-	-	1	-	232.40	-
		FB41P-WD BLK	-	-	-	1	-	232.40	-
	Brass	FB41T-WD US3	605	-	-	1	-	121.60	-
		FB41T-WD US4	606	-	-	1	-	121.60	-
		FB41T-WD US10	612	-	-	1	-	121.60	-
		FB41T-WD US10B	613	-	-	1	-	121.60	-
	Stainless	FB41T-WD US32	629	-	-	1	-	121.60	-
		FB41T-WD US32D**	630	-	-	1	-	121.60	-
		FB41T-WD BLK	-	-	-	1	-	121.60	-
	Brass	FB41B-WD US3	605	-	-	1	-	121.60	-
		FB41B-WD US4	606	-	-	1	-	121.60	-
		FB41B-WD US10	612	-	-	1	-	121.60	-
		FB41B-WD US10B	613	-	-	1	-	121.60	-
Stainless	FB41B-WD US32	629	-	-	1	-	121.60	-	
	FB41B-WD US32D	630	-	-	1	-	121.60	-	
	FB41B-WD BLK	-	-	-	1	-	121.60	-	
FS41 Automatic Floor Type Holder Floor Clearance 9/16" to 1-1/16"	Brass	FS41 US3	605	-	-	1	-	99.30	-
		FS41 US4	606	-	-	1	-	75.50	-
		FS41 US10	612	-	-	1	-	99.30	-
		FS41 US10B	613	-	-	1	-	99.30	-
		FS41 US26	625	-	-	1	-	99.30	-
		FS41 US26D**	626	-	-	1	-	75.50	-
42 Pocket Door Bolt 	Brass	42B3**	605	0.9	-	1	10	16.10	-
		42B4	606	0.9	-	1	10	16.10	-
		42B5	609	0.9	-	1	10	17.80	-
		42B10	612	0.9	-	1	10	18.50	-
		42B10B**	613	0.9	-	1	10	18.50	-
		42B15**	619	0.9	-	1	10	17.80	-
		42B26**	625	0.9	-	1	10	18.50	-
		42B26D**	626	0.9	-	1	10	18.50	-
		42B643E/716	-	0.9	-	1	10	18.50	-
42B-BLK	622	0.9	-	1	10	18.50	-		
COR42 Door Coordinator	See page 31								

Lead time exception: ** Products are stocked and will typically ship within 3 days

Bold pricing indicates item is in stock and available for **Fast Track** and **ProXpress**



MODEL	SUBSTRATE	MODEL NUMBER	BHMA FINISH	WEIGHT	MUST BE ORDERED IN MULTIPLE QTY	MULTIPLE QTY	PACKED PER BOX	LIST PRICE	
								EACH	PACKAGE
FB42 Automatic Flush Bolt Wood Door UL 20 Minutes Top Bolt w/ Auxiliary Fire Latch	Brass	FB42-WD US3	605	-	-	1	-	\$234.60	-
		FB42-WD US4	606	-	-	1	-	234.60	-
		FB42-WD US10	612	-	-	1	-	234.60	-
	Stainless	FB42-WD US10B	613	-	-	1	-	234.60	-
		FB42-WD US32	629	-	-	1	-	234.60	-
		FB42-WD US32D**	630	-	-	1	-	234.60	-
FS42 Automatic Floor Type Holder Floor Clearance 1-1/8" to 1-9/16"	Brass	FS42 US3	605	-	-	1	-	119.50	-
		FS42 US4	606	-	-	1	-	95.50	-
		FS42 US10	612	-	-	1	-	119.50	-
		FS42 US10B	613	-	-	1	-	119.50	-
		FS42 US26	625	-	-	1	-	119.50	-
		FS42 US26D	626	-	-	1	-	95.50	-
FS43 Automatic Floor Type Holder Floor Clearance 1-5/8" to 2-11/16"	Brass	FS43 US3	605	-	-	1	-	131.50	-
		FS43 US4	606	-	-	1	-	107.60	-
		FS43 US10	612	-	-	1	-	131.50	-
		FS43 US10B	613	-	-	1	-	131.50	-
		FS43 US26	625	-	-	1	-	131.50	-
		FS43 US26D	626	-	-	1	-	107.60	-
FL44 Filler Bar	See page 32								
WS45 Automatic Wall Holder For Drywall Mounting 	Brass	WS45 US3	605	-	-	1	-	171.50	-
		WS45 US4	606	-	-	1	-	171.50	-
		WS45 US10	612	-	-	1	-	171.50	-
		WS45 US10B	613	-	-	1	-	171.50	-
		WS45 US15	619	-	-	1	-	171.50	-
		WS45 US26	625	-	-	1	-	171.50	-
		WS45 US26D**	626	-	-	1	-	167.30	-
		WS45 B643E/716	-	-	-	1	-	171.50	-
	WS45 BLK	622	-	-	1	-	171.50	-	
Aluminum	WS45 US28	628	-	-	1	-	135.00	-	
WS45X Automatic Wall Holder For Masonry Mounting 	Brass	WS45X US3	605	-	-	1	-	181.50	-
		WS45X US4	606	-	-	1	-	181.50	-
		WS45X US10	612	-	-	1	-	181.50	-
		WS45X US10B	613	-	-	1	-	181.50	-
		WS45X US15	619	-	-	1	-	181.50	-
		WS45X US26	625	-	-	1	-	181.50	-
		WS45X US26D**	626	-	-	1	-	177.10	-
		WS45X B643E/716	-	-	-	1	-	181.50	-
	WS45X BLK	622	-	-	1	-	181.50	-	
Aluminum	WS45X US28	628	-	-	1	-	144.80	-	
S48 Mortise Bolt 	Brass	S48B3**	605	2.6	-	1	10	21.40	-
		S48B5	609	2.6	-	1	10	25.80	-
		S48B10B**	613	2.6	-	1	10	24.90	-
		S48B15**	619	2.6	-	1	10	24.00	-
		S48B26**	625	2.6	-	1	10	24.90	-
		S48B26D	626	2.6	-	1	10	24.90	-
S48 Strike Package		09-40-605	605	-	-	1	-	6.10	-
		09-40-613	613	-	-	1	-	6.10	-
		09-40-626	626	-	-	1	-	6.10	-
FB51 UL 3 Hour Constant Latching Top and Automatic Bottom Bolt, Metal Door  P=Pair T=Top Bolt Only B=Bottom Bolt Only Optional Rod Lengths Available 18", 24", 36", 48" 13.50 List Add	Brass	FB51P-12-MD US3	605	-	-	1	-	222.20	-
		FB51P-12-MD US4	606	-	-	1	-	222.20	-
		FB51P-12-MD US10	612	-	-	1	-	222.20	-
		FB51P-12-MD US10B	613	-	-	1	-	222.20	-
	Stainless	FB51P-12-MD US32	629	-	-	1	-	222.20	-
		FB51P-12-MD US32D	630	-	-	1	-	222.20	-
		FB51P-12-MD BLK	-	-	-	1	-	222.20	-
	Brass	FB51T-12-MD US3	605	-	-	1	-	116.00	-
		FB51T-12-MD US4	606	-	-	1	-	116.00	-
		FB51T-12-MD US10	612	-	-	1	-	116.00	-
		FB51T-12-MD US10B	613	-	-	1	-	116.00	-
	Stainless	FB51T-12-MD US32	629	-	-	1	-	116.00	-
FB51T-12-MD US32D**		630	-	-	1	-	116.00	-	
FB51T-12-MD BLK		-	-	-	1	-	116.00	-	
COR52 Door Coordinator	See page 32								

HINGES
 CONTINUOUS HINGES
 PIVOTS
 Numerical 1-059
 Numerical 59-437
 Numerical 438-1021
 Numerical 1152-8190
 Numerical 8200-9266

Lead time exception: ** Products are stocked and will typically ship within 3 days



Bold pricing indicates item is in stock and available for **Fast Track** and **ProXpress**

HINGES
 CONTINUOUS HINGES
 PIVOTS
 Numerical 1-059
 Numerical 59-437
 Numerical 438-1021
 Numerical 1152-8190
 Numerical 8200-9266

MODEL	SUBSTRATE	MODEL NUMBER	BHMA FINISH	WEIGHT	MUST BE ORDERED IN MULTIPLE QTY	MULTIPLE QTY	PACKED PER BOX	LIST PRICE	
								EACH	PACKAGE
FB52 Flush Bolt UL 3 Hour Constant Latching Top w/ Auxiliary Fire Latch	Brass	FB52-12-MD US3	605	-	-	1	-	\$222.20	-
		FB52-12-MD US4	606	-	-	1	-	222.20	-
		FB52-12-MD US10	612	-	-	1	-	222.20	-
		FB52-12-MD US10B	613	-	-	1	-	222.20	-
	Stainless	FB52-12-MD US32	629	-	-	1	-	222.20	-
		FB52-12-MD US32D**	630	-	-	1	-	222.20	-
		FB52-12-MD BLK	-	-	-	1	-	222.20	-
FB53 UL 3 Hour Constant Latching Top w/ Auxiliary Fire Latch and Retrofit Plate	Brass	FB53-12-MD US3	605	-	-	1	-	229.50	-
		FB53-12-MD US4	606	-	-	1	-	229.50	-
		FB53-12-MD US10	612	-	-	1	-	229.50	-
		FB53-12-MD US10B	613	-	-	1	-	229.50	-
	Stainless	FB53-12-MD US32	629	-	-	1	-	229.50	-
		FB53-12-MD US32D	630	-	-	1	-	229.50	-
		FB53-12-MD BLK	-	-	-	1	-	229.50	-
054 Dutch Door Bolt 	Brass	054B3	605	2.3	-	1	5	52.70	-
		054B4	606	2.3	-	1	5	52.70	-
		054B10	612	2.3	-	1	5	47.90	-
		054B10B**	613	2.3	-	1	5	57.70	-
		054B15	619	2.3	-	1	5	59.90	-
		054B26	625	2.3	-	1	5	57.70	-
		054B26D**	626	2.3	-	1	5	52.70	-
059 Handrail Bracket 	Aluminum	059A3**	666	3.2	-	1	20	4.20	-
		059A5**	-	3.2	-	1	20	4.20	-
		059A10	668	3.2	-	1	20	4.20	-
		059A10B**	703	3.2	-	1	20	4.20	-
		059A14	669	3.2	-	1	20	4.20	-
		059A15**	670	3.2	-	1	20	4.20	-
		059A26	672	3.2	-	1	20	4.20	-
		059A26D	702	3.2	-	1	20	4.20	-
		059A92**	673	3.2	-	1	20	4.20	-
		059A-643E/716**	-	3.2	-	1	20	4.20	-
		059A-BLK**	-	3.3	-	1	20	5.60	-
		059A-W**	-	3.3	-	1	20	5.60	-
		SP059A3	666	68.0	Yes	20	20	-	\$85.40
		SP059A5	-	68.0	Yes	20	20	-	85.40
		SP059A14	669	68.0	Yes	20	20	-	85.40
	SP059A92	673	68.0	Yes	20	20	-	85.40	
	Brass	059B3	605	3.2	-	1	10	24.30	-
		059B5	609	3.2	-	1	10	33.60	-
		059B10B	613	3.2	-	1	10	27.80	-
		059B15	619	3.2	-	1	10	27.80	-
		059B15A	620	3.2	-	1	10	27.80	-
		059B26	625	3.2	-	1	10	33.60	-
		059B26D	626	3.2	-	1	10	33.60	-
059B-643E/716		-	3.2	-	1	10	27.80	-	
059B-BLK		622	3.2	-	1	10	27.80	-	
SP059B10B		613	37.0	Yes	10	10	-	286.20	
SP059B26	625	37.0	Yes	10	10	-	342.40		
Zinc	059Z-619E	-	-	-	1	20	6.40	-	

Lead time exception: ** Products are stocked and will typically ship within 3 days

Bold pricing indicates item is in stock and available for **Fast Track** and **ProXpress**



MODEL	SUBSTRATE	MODEL NUMBER	BHMA FINISH	WEIGHT	MUST BE ORDERED IN MULTIPLE QTY	MULTIPLE QTY	PACKED PER BOX	LIST PRICE	
								EACH	PACKAGE
59 Handrail Bracket 	Aluminum	59A3**	666	1.6	-	1	10	\$4.30	-
		59A5	-	2.1	-	1	10	5.50	-
		59A10B**	703	3.2	-	1	10	7.50	-
		59A14**	669	2.1	-	1	10	5.50	-
		59A15**	670	2.0	-	1	10	5.50	-
		59A92**	673	3.2	-	1	10	4.30	-
		59A-643E/716**	-	2.0	-	1	10	5.50	-
		SP59A3**	666	45.0	Yes	15	15	-	\$66.30
		SP59A5	-	45.0	Yes	15	15	-	80.70
		SP59A14	669	45.0	Yes	15	15	-	80.70
	SP59A92	673	45.0	Yes	15	15	-	66.30	
	Brass	59B3**	605	3.8	-	1	10	25.60	-
		59B5	609	3.8	-	1	10	29.30	-
		59B15**	619	3.8	-	1	10	29.30	-
		59B26	625	3.8	-	1	10	29.30	-
		59B26D	626	3.8	-	1	10	29.30	-
59B-643E/716		-	3.8	-	1	10	29.30	-	
SP59B3		605	41.0	Yes	10	10	-	255.20	
060 Flexible Door Stop 3" Projection 		Steel	060F3	632	1.1	-	1	20	1.40
	060F5		638	1.1	-	1	20	1.40	-
	060F10		639	1.1	-	1	20	1.40	-
	060F10B**		640	1.1	-	1	20	1.40	-
	060F14**		645	1.1	-	1	20	1.40	-
	060F15**		646	1.1	-	1	20	1.40	-
	060F26		651	1.1	-	1	20	1.40	-
	060F26D**		652	1.1	-	1	20	1.40	-
	060F-643E/716		-	1.1	-	1	20	1.40	-
	060F-BLK**		631	1.1	-	1	20	1.40	-
	SP060F3		632	145.0	Yes	50	50	-	68.00
	SP060F5		638	145.0	Yes	50	50	-	68.00
	SP060F10B		640	145.0	Yes	50	50	-	68.00
	SP060F14		645	145.0	Yes	50	50	-	68.00
	SRT (WSPART.1076)		9	-	Yes	100	100	-	45.30
60 Door Stop 3-3/4" Projection 	Aluminum	60A3	666	1.5	-	1	20	4.00	-
		60A10B	703	1.5	-	1	20	5.60	-
		60A14	669	1.5	-	1	20	4.00	-
		60A15**	670	1.5	-	1	20	4.00	-
		60A26	672	1.5	-	1	20	4.00	-
		60A26D**	702	1.5	-	1	20	4.00	-
		60A92**	673	1.5	-	1	20	4.00	-
		60A-643E/716	-	1.5	-	1	20	5.60	-
		60A-BLK	-	1.5	-	1	20	4.00	-
		Brass	60B3	605	1.9	-	1	10	14.60
	60B4		606	1.9	-	1	10	14.60	-
	60B5		609	1.9	-	1	10	14.60	-
	60B10		612	1.9	-	1	10	19.00	-
	60B10B		613	1.9	-	1	10	19.00	-
	60B15**		619	1.9	-	1	10	19.00	-
	60B26		625	1.9	-	1	10	19.00	-
	60B26D		626	1.9	-	1	10	19.00	-
	60B-643E/716		-	1.9	-	1	10	19.00	-
	60B-BLK		622	1.9	-	1	10	19.00	-
	60 Rubber Tips		RT (WSPART.1075)	-	-	Yes	100	100	-
COR60 Door Coordinator	See page 32								

HINGES
 CONTINUOUS HINGES
 PIVOTS
 Numerical 1-059
 Numerical 59-437
 Numerical 438-1021
 Numerical 1152-8190
 Numerical 8200-9266

Lead time exception: ** Products are stocked and will typically ship within 3 days







Bold pricing indicates item is in stock and available for **Fast Track** and **ProXpress**

HINGES
 CONTINUOUS HINGES
 PIVOTS
 Numerical 1-059
 Numerical 59-437
 Numerical 438-1021
 Numerical 1152-8190
 Numerical 8200-9266

MODEL	SUBSTRATE	MODEL NUMBER	BHMA FINISH	WEIGHT	MUST BE ORDERED IN MULTIPLE QTY	MULTIPLE QTY	PACKED PER BOX	LIST PRICE	
								EACH	PACKAGE
061 Flexible Door Stop 4" Projection 	Steel	061F3	632	1.4	-	1	20	\$1.50	-
		061F5	638	1.4	-	1	20	1.50	-
		061F10	639	1.4	-	1	20	1.50	-
		061F10B	640	1.4	-	1	20	1.50	-
		061F14	645	1.4	-	1	20	1.50	-
		061F15	646	1.4	-	1	20	1.50	-
		061F26	651	1.4	-	1	20	1.50	-
		061F26D**	652	1.4	-	1	20	1.50	-
		061F-643E/716	-	1.4	-	1	20	1.50	-
		061F-BLK	631	1.4	-	1	20	1.50	-
		061F-W	-	1.4	-	1	20	1.50	-
		SP061F3	632	47.5	Yes	25	25	-	37.50
		SP061F5	638	47.5	Yes	25	25	-	37.50
SP061F14	645	47.5	Yes	25	25	-	37.50		
Rubber Tip - Flexible Stops	Rubber	SRT (WSPART.1076)	-	-	Yes	100	100	-	45.30
61 Solid Door Stop 3-3/16" Projection  *Provided with Black Rubber Tip	Aluminum	61A3**	666	1.2	-	1	20	4.00	-
		61A5	-	1.2	-	1	20	4.00	-
		61A10	668	1.2	-	1	20	4.00	-
		61A10B**	703	1.2	-	1	20	4.00	-
		61A14**	669	1.2	-	1	20	4.00	-
		61A15**	670	1.2	-	1	20	4.00	-
		61A26	672	1.2	-	1	20	4.00	-
		61A26D	702	1.2	-	1	20	4.00	-
		61A92**	673	1.2	-	1	20	4.00	-
		*61A 643E/716**	-	1.2	-	1	20	4.00	-
		61A-BLK**	-	1.3	-	1	20	4.40	-
		61A-W**	-	1.3	-	1	20	4.40	-
		SP61A10B	703	42.5	Yes	25	25	-	106.25
		SP61A3	666	42.5	Yes	25	25	-	106.25
		SP61A5	-	42.5	Yes	25	25	-	106.25
		SP61A14	669	42.5	Yes	25	25	-	106.25
		SP61A92	673	42.5	Yes	25	25	-	106.25
SP61A-BLK	-	20.0	Yes	10	10	-	45.20		
SP61A-W	-	50.0	Yes	25	25	-	113.00		
61 Solid Door Stop 3-1/8" Projection 	Brass	61B3**	605	1.4	-	1	10	14.60	-
		61B4	606	1.4	-	1	10	14.60	-
		61B5**	609	1.4	-	1	10	14.60	-
		61B10	612	1.4	-	1	10	19.00	-
		61B10B**	613	1.4	-	1	10	19.00	-
		61B15**	619	1.4	-	1	10	19.00	-
		61B15A	620	1.4	-	1	10	19.00	-
		61B26**	625	1.4	-	1	10	19.00	-
		61B26D**	626	1.4	-	1	10	14.60	-
		61B-643E/716	-	1.4	-	1	10	19.00	-
		61B-BLK	622	1.4	-	1	10	19.00	-
		SP61B 10B	613	-	Yes	10	10	-	197.10
		SP61B26 (WS.10347)	625	-	Yes	10	10	-	197.10

Lead time exception: ** Products are stocked and will typically ship within 3 days

Bold pricing indicates item is in stock and available for **Fast Track** and **ProXpress**

MODEL	SUBSTRATE	MODEL NUMBER	BHMA FINISH	WEIGHT	MUST BE ORDERED IN MULTIPLE QTY	MULTIPLE QTY	PACKED PER BOX	LIST PRICE		
								EACH	PACKAGE	
61 Solid Door Stop 3-3/16" Projection <i>Continued from previous page</i> 61 Rubber Tips	Zinc	61Z-619E	-	4.1	-	1	20	\$3.70	-	
		61Z-643E/716**	-	-	-	1	20	4.90	-	
			RT (WSPART.1075)	-	-	Yes	100	100	-	\$97.00
FB61 Flush Bolt for Wood Door UL 90 Minute Constant Latching Top and Automatic Bottom Bolt P=Pair (Top half w/automatic bottom bolt) T=Top Bolt Only 	Brass	FB61P-WD US3	605	-	-	1	-	234.60	-	
		FB61P-WD US4	606	-	-	1	-	234.60	-	
		FB61P-WD US10	612	-	-	1	-	234.60	-	
		FB61P-WD US10B	613	-	-	1	-	234.60	-	
	Stainless	FB61P-WD US32	629	-	-	1	-	234.60	-	
		FB61P-WD US32D**	630	-	-	1	-	234.60	-	
		FB61P-WD BLK	-	-	-	1	-	234.60	-	
	Brass	FB61T-WD US3	605	-	-	1	-	121.60	-	
		FB61T-WD US4	606	-	-	1	-	121.60	-	
		FB61T-WD US10	612	-	-	1	-	121.60	-	
		FB61T-WD US10B	613	-	-	1	-	121.60	-	
	Stainless	FB61T-WD US32	629	-	-	1	-	121.60	-	
FB61T-WD US32D**		630	-	-	1	-	121.60	-		
FB61T-WD BLK		-	-	-	1	-	121.60	-		
FB62 Flush Bolt for Wood Door UL 20 Minute Constant Latching Top w/Auxiliary Fire Latch	Brass	FB62-WD US3	605	-	-	1	-	234.60	-	
		FB62-WD US4	606	-	-	1	-	234.60	-	
		FB62-WD US10	612	-	-	1	-	234.60	-	
		FB62-WD US10B	613	-	-	1	-	234.60	-	
	Stainless	FB62-WD US32	629	-	-	1	-	234.60	-	
		FB62-WD US32D	630	-	-	1	-	234.60	-	
		FB62-WD BLK	-	-	1	-	234.60	-		
63 Flexible Door Stop 	Steel	63F-605E	632	2.7	-	1	20	1.20	-	
		63F-609E	638	2.7	-	1	20	1.20	-	
		63F-619E**	646	1.8	-	1	20	1.20	-	
		63F-625E	-	1.8	-	1	20	1.20	-	
		63F-626E**	-	1.8	-	1	20	1.20	-	
		63F-643E/716**	-	1.8	-	1	20	1.20	-	
		63F-BLK**	631	1.8	-	1	20	1.20	-	
		63F-W**	-	1.8	-	1	20	1.20	-	
63 Rubber Tips		RT (WSPART.1075)	-	-	Yes	100	100	-	97.00	
64 Door Stop 3-1/4" Projection 	Aluminum	64A3	666	2.3	-	1	20	3.40	-	
		64A10B	703	2.3	-	1	20	3.40	-	
		64A92**	673	2.3	-	1	20	3.40	-	
	Brass	64B3	605	-	-	1	10	13.00	-	
		64B4	606	-	-	1	10	14.20	-	
		64B5	609	2.1	-	1	10	16.70	-	
		64B10	612	2.3	-	1	10	16.70	-	
		64B10B	613	2.3	-	1	10	16.70	-	
		64B15	619	2.3	-	1	10	16.70	-	
		64B26	625	2.3	-	1	10	16.70	-	
		64B26D**	626	2.3	-	1	10	16.70	-	
		64B-643E/716	-	2.3	-	1	10	16.70	-	
		64B-BLK	622	2.3	-	1	10	16.70	-	
		64 Rubber Tips		RT (WSPART.1075)	-	-	Yes	100	100	-
SR64 Door Silencer - Hollow Metal 		SR64 GRY (100/pk)**	-	2.1	-	1	100	38.00	-	
		SR64 GRY - BULK (2500/pk)	-	-	-	1	2,500	575.30	-	
WS65 Wall Stop 	Aluminum	WS65 US3AL	666	2.8	-	1	20	5.50	-	
		WS65 US10AL	668	2.1	-	1	20	5.50	-	
		WS65 US10B-AL	703	2.8	-	1	20	5.50	-	
		WS65 US27**	673	-	-	1	20	5.50	-	
		SPWS65 US3AL	666	-	-	Yes	25	25	-	131.00
		SPWS65 US27	673	-	-	Yes	25	25	-	131.00
WS65 Rubber Tips		RT (WSPART.1075)	-	-	Yes	100	100	-	97.00	
SR65 Door Silencer - Wood 		SR65 GRY (100/pk)**	-	-	-	1	100	38.00	-	
SR66 Door Silencer - Adhesive 		SR66 BRN (100/pk)	-	-	-	1	100	38.00	-	
		SR66 GRY (100/pk)**	-	-	-	1	100	38.00	-	
		SR66 WHT (100/pk)	-	-	-	1	100	38.00	-	

Lead time exception: ** Products are stocked and will typically ship within 3 days

Bold pricing indicates item is in stock and available for **Fast Track** and **ProXpress**





HINGES
CONTINUOUS HINGES
PIVOTS
Numerical 1-059
Numerical 59-437
Numerical 438-1021
Numerical 1152-8190
Numerical 8200-9266

HINGES

CONTINUOUS
HINGES









PIVOTS

Numerical
1-059Numerical
59-437Numerical
438-1021Numerical
1152-8190Numerical
8200-9266

MODEL	SUBSTRATE	MODEL NUMBER	BHMA FINISH	WEIGHT	MUST BE ORDERED IN MULTIPLE QTY	MULTIPLE QTY	PACKED PER BOX	LIST PRICE	
								EACH	PACKAGE
066 Casement Fastener 	Aluminum	066A3 RS MS SS	666	-	-	1	10	\$7.20	-
		066A5 RS MS SS	-	-	-	1	10	7.20	-
		066A10B RS MS SS**	703	-	-	1	10	7.20	-
		066A14 RS MS SS	669	-	-	1	10	7.20	-
		066A92 RS MS SS	673	-	-	1	10	7.20	-
	Brass	066B3 RS MS SS	605	-	-	1	10	31.80	-
		066B5 RS MS SS	609	-	-	1	10	38.30	-
		066B15 RS MS SS	619	-	-	1	10	39.70	-
		066B26 RS MS SS	625	-	-	1	10	38.30	-
		066B26D RS MS SS	626	-	-	1	10	38.30	-
66 Casement Fastener 	Aluminum	66A3 RS MS SS	666	-	-	1	10	8.30	-
		66A5 RS MS SS**	-	-	-	1	10	8.30	-
		66A14 RS MS SS	669	-	-	1	10	8.30	-
		66A92 RS MS SS	673	-	-	1	10	8.30	-
	Brass	66B3 RS MS SS	605	-	-	1	10	38.90	-
		66B5 RS MS SS	609	-	-	1	10	38.90	-
		66B15 RS MS SS	619	-	-	1	10	38.90	-
		66B26 RS MS SS	625	-	-	1	10	38.90	-
		66B26D RS MS SS	626	-	-	1	10	38.90	-
		66B643E/716 RS MS SS	-	-	-	1	10	38.90	-
69 Hinge Pin Door Stop Door Opening Adjustments 70° - 100° 	Steel	69F3	632	2.6	-	1	20	5.10	-
		69F5	638	2.6	-	1	20	5.10	-
		69F10	639	2.6	-	1	20	5.10	-
		69F10B**	640	2.6	-	1	20	5.10	-
		69F14**	645	2.6	-	1	20	5.10	-
		69F15**	646	2.6	-	1	20	5.10	-
		69F15A	647	2.6	-	1	20	5.10	-
		69F26	651	2.6	-	1	20	5.10	-
		69F26D**	652	2.6	-	1	20	5.10	-
		69F-643E/716	-	2.6	-	1	20	5.10	-
		69F-BLK**	631	2.6	-	1	20	5.10	-
		SP69F3	632	82.5	Yes	25	25	-	126.50
		SP69F5	635	82.5	Yes	25	25	-	126.50
		SP69F14	645	82.5	Yes	25	25	-	126.50
69 Rubber Tip		09-310	-	-	Yes	100	100	90.50	-
70 Hinge Pin Door Stop Door Opening Adjustments 85° - 125°  *Provided with Black Rubber Tip Picture above for Brass and Zinc Substrates  Picture above for Aluminum Substrates <i>Continued on next page.</i>	Aluminum	70A3**	666	1.3	-	1	20	2.70	-
		70A4	667	1.3	-	1	20	2.70	-
		70A5	-	1.3	-	1	20	3.10	-
		70A10	668	1.3	-	1	20	2.70	-
		70A10B**	703	1.3	-	1	20	3.10	-
		70A14**	669	1.3	-	1	20	3.10	-
		70A15**	670	1.3	-	1	20	3.10	-
		70A26	672	1.3	-	1	20	2.70	-
		70A26D**	702	1.3	-	1	20	2.70	-
		70A92**	673	1.3	-	1	20	2.70	-
		*70A 643E/716**	-	1.3	-	1	20	3.10	-
		70A-BLK**	-	1.4	-	1	20	3.70	-
		70A-W**	-	1.4	-	1	20	3.70	-
		SP70A3	666	55.0	Yes	25	25	-	69.00
	SP70A5	-	55.0	Yes	25	25	-	78.75	
	SP70A10	668	55.0	Yes	25	25	-	69.00	
	SP70A92	673	55.0	Yes	25	25	-	69.00	
	Brass	70B3	605	1.4	-	1	10	13.40	-
		70B4	606	1.4	-	1	10	13.40	-
		70B5	609	1.4	-	1	10	17.00	-
70B10		612	1.4	-	1	10	17.00	-	
70B10B**		613	1.4	-	1	10	17.00	-	
70B15**		619	1.4	-	1	10	17.00	-	
70B26	625	1.4	-	1	10	17.00	-		
70B26D**	626	1.4	-	1	10	17.00	-		
70B643E/716	-	1.4	-	1	10	17.00	-		
70B-BLK	622	1.4	-	1	10	17.00	-		

Lead time exception: ** Products are stocked and will typically ship within 3 days

Bold pricing indicates item is in stock and available for **Fast Track** and **ProXpress**

MODEL	SUBSTRATE	MODEL NUMBER	BHMA FINISH	WEIGHT	MUST BE ORDERED IN MULTIPLE QTY	MULTIPLE QTY	PACKED PER BOX	LIST PRICE	
								EACH	PACKAGE
70 Hinge Pin Door Stop Door Opening Adjustments 85° - 125°  <i>Continued from previous page.</i>	Zinc	70Z-406E	-	-	-	1	10	\$3.70	-
		70Z-643E/716	-	-	-	1	20	3.70	-
70 Rubber Tips		RT (WSPART.1075)	-	-	Yes	100	100	-	97.00
71 Casement Adjuster 	Brass	71B3 10 IN	605	1.7	-	1	2	76.30	-
		71B3 12 IN	605	1.9	-	1	2	83.00	-
		71B26 10 IN	625	1.7	-	1	2	76.30	-
		71B26 12 IN	625	1.9	-	1	2	83.00	-
72 Door Saver Residential 	Zinc	72Z-605E	677	-	-	1	50	3.10	-
		72Z-609E	-	-	-	1	50	3.10	-
		72Z-613E	704	-	-	1	50	3.10	-
		72Z-619E **	-	-	-	1	50	3.10	-
		72Z-625E	681	-	-	1	50	3.10	-
		72Z-626E	682	-	-	1	50	3.10	-
		72Z-643E/716	-	-	-	1	50	3.10	-
		72Z-BLK	676	-	-	1	50	3.10	-
72Z-W	-	-	-	1	50	3.10	-		
72 Rubber Tips		RT (WSPART.1075)	-	-	Yes	100	100	-	97.00
COR72 Door Coordinator	See page 36								
73 Door Saver Residential 	Zinc	73Z-605E	677	-	-	1	25	6.10	-
		73Z-613E	704	-	-	1	25	6.10	-
		73Z-619E**	-	-	-	1	25	6.10	-
		73Z-625E	681	-	-	1	25	6.10	-
73 Rubber Tips		RT (WSPART.1075)	-	-	Yes	100	100	-	97.00
90 Side Window Lock 	Aluminum	SP90A3	666	45.0	Yes	25	25	-	123.25
FP100 Foot Pull 	Stainless	FP100 US32D	630	-	-	1	1	103.00	-
		FP100 SP313/695	695	-	-	1	1	123.80	-
		FP100 BLK	631	-	-	1	1	123.80	-
AP101 Arm Pull 	Stainless	AP101 US32D	630	-	-	1	1	113.40	-
		AP101 SP313/695	695	-	-	1	1	134.20	-
		AP101 BLK	631	-	-	1	1	134.20	-
CS115 Crash Stop 	Steel	CS115 US10B 20 1/2 IN	613	5.0	-	1	5	56.30	-
		CS115 US10B 25 1/2 IN**	613	5.5	-	1	5	60.00	-
		CS115 US10B 30 1/2 IN	613	6.0	-	1	5	66.60	-
		CS115 US26D 20 1/2 IN**	626	5.0	-	1	5	56.30	-
		CS115 US26D 25 1/2 IN**	626	5.5	-	1	5	60.00	-
		CS115 US26D 30 1/2 IN**	626	6.0	-	1	5	66.60	-
HB159 Handrail Bracket 	Aluminum	HB159 US3AL	666	3.8	-	1	5	19.10	-
		HB159 US27	673	3.8	-	1	5	19.10	-

Lead time exception: ** Products are stocked and will typically ship within 3 days

Bold pricing indicates item is in stock and available for **Fast Track** and **ProXpress**

HINGES

CONTINUOUS HINGES

PIVOTS

Numerical 1-059

Numerical 59-437

Numerical 438-1021

Numerical 1152-8190



Numerical 8200-9266

HINGES

CONTINUOUS
HINGES

PIVOTS

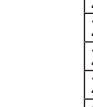
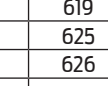

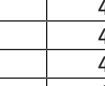
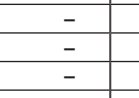

Numerical
1-059Numerical
59-437Numerical
438-1021Numerical
1152-8190Numerical
8200-9266

MODEL	SUBSTRATE	MODEL NUMBER	BHMA FINISH	WEIGHT	MUST BE ORDERED IN MULTIPLE QTY	MULTIPLE QTY	PACKED PER BOX	LIST PRICE	
								EACH	PACKAGE
218* Finger Pull 1" Diameter 	Brass	218B3	605	1.6	Yes	4	40	-	\$11.90
		218B5	609	1.6	Yes	4	40	-	22.70
		218B10	612	1.6	Yes	4	40	-	22.70
		218B10B	613	1.6	Yes	4	40	-	22.70
		218B15**	619	1.6	Yes	4	40	-	11.90
		218B26	625	1.6	Yes	4	40	-	16.10
		218B26D	626	1.6	Yes	4	40	-	16.10
		218B-643E/716	-	1.6	Yes	4	40	-	16.10
		218B-BLK	622	1.6	Yes	4	40	-	16.10
221 Flush Pull 2-1/8" Diameter 	Brass	221B3	605	1.0	-	1	20	\$4.30	
		221B4	606	1.0	-	1	20	4.30	
		221B5	609	1.0	-	1	20	4.30	
		221B10	612	1.0	-	1	20	5.90	
		221B10B**	613	1.0	-	1	20	5.10	
		221B15**	619	1.0	-	1	20	4.90	
		221B26**	625	1.0	-	1	20	5.10	
		221B26D**	626	1.0	-	1	20	5.10	
		221B-643E/716**	716	1.0	-	1	20	5.10	
		221B-BLK**	622	1	-	1	20	5.10	
222 Flush Pull 3-1/8" High x 1-5/8" Wide x 7/16" 	Brass	222B3	605	1.5	-	1	10	25.10	-
		222B4	606	1.5	-	1	10	25.10	-
		222B5	609	1.5	-	1	10	28.70	-
		222B10	612	1.5	-	1	10	28.70	-
		222B10B**	613	1.5	-	1	10	28.70	-
		222B15**	619	1.5	-	1	10	27.80	-
		222B26	625	1.5	-	1	10	28.70	-
		222B26D**	626	1.5	-	1	10	28.70	-
		222B-643E/716	-	1.5	-	1	10	28.70	-
		222B-BLK	622	1.5	-	1	10	28.70	-
223 Flush Pull 3-9/16" High x 1-5/16" Wide x 1/2" Deep 	Brass	223B3	605	0.7	-	1	10	7.70	-
		223B4	606	0.7	-	1	10	7.70	-
		223B10	612	0.7	-	1	10	8.60	-
		223B10B**	613	0.7	-	1	10	8.60	-
		223B15**	619	0.7	-	1	10	8.20	-
		223B26	625	0.7	-	1	10	8.60	-
		223B26D**	626	0.7	-	1	10	8.60	-
		223B-643E/716	-	0.7	-	1	10	8.60	-
		223B-BLK	622	0.7	-	1	10	8.60	-
		227 Flush Pull 3-5/8" High x 1-3/4" Wide x 9/16" Deep 	Brass	227B3	605	1.0	-	1	10
227B4	606			1.0	-	1	10	11.40	-
227B5	609			1.0	-	1	10	12.80	-
227B10	612			1.0	-	1	10	13.30	-
227B10B**	613			1.0	-	1	10	13.30	-
227B15**	619			1.0	-	1	10	12.80	-
227B26**	625			1.0	-	1	10	13.30	-
227B26D**	626			1.0	-	1	10	13.30	-
227B-643E/716	-			1	-	1	10	13.30	-
227B-BLK**	622			1	-	1	10	13.30	-
230 Door Edge Pull 	Brass	230B3	605	1.3	-	1	10	16.30	-
		230B4	606	1.3	-	1	10	16.30	-
		230B5	609	1.3	-	1	10	17.80	-
		230B10	612	1.3	-	1	10	16.30	-
		230B10B**	613	1.3	-	1	10	18.60	-
		230B15**	619	1.3	-	1	10	17.80	-
		230B26**	625	1.3	-	1	10	18.60	-
		230B26D**	626	1.3	-	1	10	18.60	-
		230B-643E/716	-	1.3	-	1	10	18.60	-
		230B-BLK**	622	1.3	-	1	10	18.60	-

* NOTE: 218 Finger Pull priced at 4 per bag. Qty of 10 = 40 pieces.

Lead time exception: ** Products are stocked and will typically ship within 3 days

Bold pricing indicates item is in stock and available for **Fast Track** and **ProXpress**

MODEL	SUBSTRATE	MODEL NUMBER	BHMA FINISH	WEIGHT	MUST BE ORDERED IN MULTIPLE QTY	MULTIPLE QTY	PACKED PER BOX	LIST PRICE	
								EACH	PACKAGE
253 Decorative Heavy Duty Surface Bolt 	Brass	253B3 8 IN US MS	605	-	-	1	5	\$75.20	-
		253B10B 8 IN US MS	613	-	-	1	5	86.50	-
		253B26D 8 IN US MS	626	-	-	1	5	86.50	-
		253B3 12 IN US MS	605	-	-	1	5	98.90	-
		253B10B 12 IN US MS	613	-	-	1	5	105.80	-
		253B26D 12 IN US MS	626	-	-	1	5	105.80	-
253 Mortise Strike Package	Brass	09-22-605	605	-	-	1	1	10.00	-
		09-22-613	613	-	-	1	1	10.00	-
		09-22-626	626	-	-	1	1	10.00	-
253 Angle Strike Package	Brass	09-33-605	605	-	-	1	1	22.30	-
		09-33-613	613	-	-	1	1	22.30	-
		09-33-626	626	-	-	1	1	22.30	-
261 Manual Flush Bolt 	Brass	261B3	605	2.4	-	1	10	22.90	-
		261B5	609	2.4	-	1	10	25.20	-
		261B10B	613	2.4	-	1	10	28.90	-
		261B15**	619	2.4	-	1	10	26.20	-
		261B26	625	2.4	-	1	10	26.20	-
		261B26D	626	2.4	-	1	10	26.20	-
		SP261B3	605	3.8	Yes	15	15	-	\$345.90
		SP261B5	619	0.0	Yes	15	15	-	393.75
262 Manual Flush Bolt 	Brass	262B3	605	3.6	-	1	10	33.60	-
		262B5	609	3.6	-	1	10	37.00	-
		262B10B**	613	3.6	-	1	10	38.70	-
		262B15**	619	3.6	-	1	10	38.70	-
		262B26	625	3.6	-	1	10	38.70	-
		262B26D**	626	3.6	-	1	10	38.70	-
262 Strike Package		09-40-605	605	-	-	1	1	6.10	-
		09-40-613	613	-	-	1	1	6.10	-
		09-40-626	626	-	-	1	1	6.10	-
265 Manual Flush Bolt 	Brass	265B3**	605	2.1	-	1	10	26.10	-
		265B5	609	2.1	-	1	10	28.70	-
		265B10B	613	2.1	-	1	10	30.20	-
		265B15	619	2.1	-	1	10	30.20	-
		265B26	625	2.1	-	1	10	30.20	-
		265B26D	626	2.1	-	1	10	30.20	-
265 Strike Package		09-40-605	605	-	-	1	1	6.10	-
		09-40-613	613	-	-	1	1	6.10	-
		09-40-626	626	-	-	1	1	6.10	-
299 Center Rescue Strike All Strikes Double Lip. Must be used with Center Hung Pivots. Strike Dimension Options: #7 Stk = 5 3/4" x 2 3/4" Frame #8 Stk = 6 3/4" x 2 3/4" Frame		299RS-7	630	-	-	1	-	59.00	-
		299RS-8	630	-	-	1	-	59.00	-
299 Offset Rescue Strike All Strikes Double Lip. Must be used with Center Hung Pivots. Strike Dimension Options: #7 Stk = 5 3/4" x 2 3/4" Frame #8 Stk = 6 3/4" x 2 3/4" Frame		299RB-7	630	-	-	1	-	59.00	-
		299RB-8	630	-	-	1	-	59.00	-
299 Rescue Emergency Stop (Stop Assembly Only)		299AL	630	-	-	1	-	124.80	-
299 Rescue Center Emergency Stop Strike (Part) All Strikes Double Lip. Must be used with Center Hung Pivots. Strike Dimension Options: #7 Stk = 5 3/4" x 2 3/4" Frame #8 Stk = 6 3/4" x 2 3/4" Frame		299ES-7	630	-	-	1	-	78.50	-
		299ES-8	630	-	-	1	-	78.50	-

HINGES
 CONTINUOUS HINGES
 PIVOTS
 Numerical 1-059
 Numerical 59-437
 Numerical 438-1021
 Numerical 1152-8190
 Numerical 8200-9266

Lead time exception: ** Products are stocked and will typically ship within 3 days

Bold pricing indicates item is in stock and available for **Fast Track** and **ProXpress**

HINGES

CONTINUOUS HINGES

PIVOTS



Numerical 1-059

Numerical 59-437

Numerical 438-1021







Numerical 1152-8190

Numerical 8200-9266

MODEL	SUBSTRATE	MODEL NUMBER	BHMA FINISH	WEIGHT	MUST BE ORDERED IN MULTIPLE QTY	MULTIPLE QTY	PACKED PER BOX	LIST PRICE	
								EACH	PACKAGE
299 Rescue Offset Emergency Stop Strike (Part) All Strikes Double Lip. Must be used with Center Hung Pivots. Strike Dimension Options: #7 Stk = 5 3/4" x 2 3/4" Frame #8 Stk = 6 3/4" x 2 3/4" Frame		299EB-7	630	-	-	1	-	\$78.50	-
		299EB-8	630	-	-	1	-	78.50	-
299 Rescue Center Emergency Strike Assembly All Strikes Double Lip. Must be used with Center Hung Pivots. Strike Dimension Options: #7 Stk = 5 3/4" x 2 3/4" Frame #8 Stk = 6 3/4" x 2 3/4" Frame		299AS-7**	630	-	-	1	-	203.30	-
		299AS-8	630	-	-	1	-	203.30	-
299 Rescue Offset Emergency Strike Assembly All Strikes Double Lip. Must be used with Center Hung Pivots. Strike Dimension Options: #7 Stk = 5 3/4" x 2 3/4" Frame #8 Stk = 6 3/4" x 2 3/4" Frame		299AB-7**	630	-	-	1	-	203.30	-
		299AB-8	630	-	-	1	-	203.30	-
OT300 	Stainless	OT300 US32D	630	-	-	1	10	30.20	-
		OT300 BLK	631	-	-	1	10	30.20	-
OTP300 	Plastic	OTP300 BLK	BLK	-	-	10	10	-	156.00
325 Magnetic Catch	Aluminum	325A3	666	1.9	-	1	20	3.50	-
		325A92**	673	1.9	-	1	20	3.50	-
326 Heavy Duty Magnetic Catch	Aluminum	326A3**	666	3.0	-	1	10	9.90	-
		326A92**	673	3.0	-	1	10	9.90	-
327 Magnetic Catch Dual Triple Pole	Aluminum	327A3**	666	4.0	-	1	10	16.80	-
		327A92**	673	4.0	-	1	10	16.80	-
330 Double Roller Catch	Steel	330F2C	604	1.1	-	1	30	2.20	-
		SP330F2C	604	2.3	Yes	50	50	-	\$106.80
335 Roller Catch Adjustable	Brass	335B3**	605	1.6	-	1	10	16.80	-
		335B5	609	1.6	-	1	10	20.10	-
		335B10	612	1.6	-	1	10	20.10	-
		335B10B**	613	1.6	-	1	10	20.10	-
		335B15**	619	1.6	-	1	10	21.00	-
		335B26	625	1.6	-	1	10	20.10	-
		335B26D**	626	1.6	-	1	10	20.10	-
		335B-643E/716	-	1.6	-	1	10	20.10	-
335 Strike & Mounting Package		09-45-613	613	-	-	1	1	7.50	-
		09-45-619	619	-	-	1	1	7.50	-
336 Roller Catch Adjustable	Brass	336B3	605	1.6	-	1	10	15.30	-
		336B4	606	1.6	-	1	10	20.10	-
		336B5	609	1.6	-	1	10	20.10	-
		336B10	612	1.6	-	1	10	20.10	-
		336B10B**	613	1.6	-	1	10	20.10	-
		336B15	619	1.6	-	1	10	20.10	-
		336B26	625	1.6	-	1	10	20.10	-
		336B26D**	626	1.6	-	1	10	18.60	-
336 Strike & Mounting Package		09-47-605	605	-	-	1	1	8.10	-
		09-47-613	613	-	-	1	1	8.10	-
		09-47-626	626	-	-	1	1	8.10	-

Lead time exception: ** Products are stocked and will typically ship within 3 days

Bold pricing indicates item is in stock and available for **Fast Track** and **ProXpress**

MODEL	SUBSTRATE	MODEL NUMBER	BHMA FINISH	WEIGHT	MUST BE ORDERED IN MULTIPLE QTY	MULTIPLE QTY	PACKED PER BOX	LIST PRICE	
								EACH	PACKAGE
345 Ball Catch 	Brass	345B3**	605	0.8	-	1	10	\$9.90	-
		345B5	609	0.8	-	1	10	10.80	-
		345B10	612	0.8	-	1	10	11.20	-
		345B10B	613	0.8	-	1	10	11.20	-
		345B15	619	0.8	-	1	10	11.50	-
		345B26	625	0.8	-	1	10	11.20	-
		345B26D	626	0.8	-	1	10	11.20	-
347 Ball Catch 	Brass	347B3**	605	1.9	-	1	10	14.70	-
		347B4**	606	1.9	-	1	10	14.70	-
		347B5**	609	1.9	-	1	10	15.80	-
		347B10	612	1.9	-	1	10	16.60	-
		347B10B**	613	1.9	-	1	10	16.60	-
		347B15**	619	1.9	-	1	10	15.80	-
		347B26**	625	1.9	-	1	10	16.60	-
		347B26D**	626	1.9	-	1	10	16.60	-
		347B-643E/716	-	1.9	-	1	10	16.60	-
		347B-BLK	622	1.9	-	1	10	16.60	-
347 Strike & Mounting Package		09-53-605	605	-	-	1	10	7.50	-
		09-53-613	613	-	-	1	10	7.50	-
		09-53-619	619	-	-	1	10	7.50	-
		09-53-625	625	-	-	1	10	7.50	-
		09-53-626	626	-	-	1	10	7.50	-
349 Ball Catch 	Brass	349B3	605	1.8	-	1	10	14.70	-
		349B4	606	1.8	-	1	10	14.70	-
		349B5	609	1.8	-	1	10	17.40	-
		349B10	612	1.8	-	1	10	17.40	-
		349B10B**	613	1.8	-	1	10	17.40	-
		349B15**	619	1.8	-	1	10	18.00	-
		349B26	625	1.8	-	1	10	17.40	-
		349B26D**	626	1.8	-	1	10	17.40	-
		349B-643E/716	-	1.8	-	1	10	17.40	-
349B-BLK	622	1.8	-	1	10	17.40	-		
349 Strike & Mounting Package		09-61-605	-	-	-	1	1	7.50	-
		09-61-613	-	-	-	1	1	7.50	-
		09-61-626	-	-	-	1	1	7.50	-
FB358 Manual Flush Bolt Wood Door UL 90 Minutes 	Brass	FB358 US3	605	1.7	-	1	2	43.20	-
		FB358 US4	606	1.7	-	1	2	43.20	-
		FB358 US10	612	1.7	-	1	2	43.20	-
		FB358 US10B**	613	1.7	-	1	2	43.20	-
		FB358 US15	619	1.8	-	1	5	43.20	-
		FB358 US26	625	1.7	-	1	2	43.20	-
		FB358 US26D**	626	1.7	-	1	2	43.20	-
		FB358 643E/716	-	1.7	-	1	2	43.20	-
		FB358 BLK**	622	1.7	-	1	2	43.20	-
SB360 Surface Bolt Heavy Duty, UL Listed	Steel	SB360 US2C 12 IN**	604	3.5	-	1	1	127.70	-
		SB360 - MS Strike Package	09-82-604	604	-	-	1	1	28.40
SB360 - SNB Package		09-350-604	604	-	-	1	1	23.30	-
401/402CVX Wall Bumper w/Plastic Anchor Convex Rubber, with drywall and masonry anchors. 	Brass	WS401/402 CVX US3	605	2.9	-	1	10	19.20	-
		WS401/402 CVX US4	606	2.9	-	1	10	22.30	-
		WS401/402 CVX US10	612	2.9	-	1	10	22.30	-
		WS401/402 CVX US10B**	613	2.9	-	1	10	22.30	-
		WS401/402 CVX US15	619	2.9	-	1	10	22.30	-
		WS401/402 CVX US26	625	2.9	-	1	10	22.30	-
		WS401/402 CVX US26D**	626	2.9	-	1	10	22.30	-
401/402CCV Wall Bumper w/Plastic Anchor Concave Rubber, with drywall and masonry anchors. 	Brass	WS401/402 CCV US3	605	3.1	-	1	10	19.20	-
		WS401/402 CCV US4	606	3.1	-	1	10	22.30	-
		WS401/402 CCV US10	612	3.1	-	1	10	22.30	-
		WS401/402 CCV US10B**	613	3.1	-	1	10	22.30	-
		WS401/402 CCV US15	619	3.1	-	1	10	22.30	-
		WS401/402 CCV US26	625	3.1	-	1	10	22.30	-
		WS401/402 CCV US26D**	626	3.1	-	1	10	22.30	-

HINGES
 CONTINUOUS HINGES
 PIVOTS
 Numerical 1-059
 Numerical 59-437
 Numerical 438-1021
 Numerical 1152-8190
 Numerical 8200-9266

Lead time exception: ** Products are stocked and will typically ship within 3 days





Bold pricing indicates item is in stock and available for **Fast Track** and **ProXpress**

HINGES

CONTINUOUS
HINGES





PIVOTS

Numerical
1-059Numerical
59-437Numerical
438-1021Numerical
1152-8190Numerical
8200-9266

MODEL	SUBSTRATE	MODEL NUMBER	BHMA FINISH	WEIGHT	MUST BE ORDERED IN MULTIPLE QTY	MULTIPLE QTY	PACKED PER BOX	LIST PRICE	
								EACH	PACKAGE
WS404-CVX Small Wall Stop Convex Rubber 1" Base Diameter 	Brass	WS404 US3	605	1.0	-	1	20	\$6.80	-
		WS404 US4	606	1.0	-	1	20	8.00	-
		WS404 US5	609	1.0	-	1	20	8.00	-
		WS404 US10	612	1.0	-	1	20	8.00	-
		WS404 US10B	613	1.0	-	1	20	8.00	-
		WS404 US15	619	1.0	-	1	20	8.30	-
		WS404 US26	625	1.0	-	1	20	8.00	-
		WS404 US26D**	626	1.0	-	1	20	8.00	-
		WS404 643E/716	-	1	-	1	20	8.00	-
		WS404 BLK	622	1	-	1	20	8.00	-
405 Coat and Hat Hook 	Aluminum	405A3	666	1.5	-	1	20	2.90	-
		405A4	667	1.5	-	1	20	2.90	-
		405A5	-	1.5	-	1	20	2.90	-
		405A10	668	1.5	-	1	20	2.90	-
		405A10B	703	1.5	-	1	20	2.90	-
		405A14	669	1.5	-	1	20	2.90	-
		405A92**	673	1.5	-	1	20	2.90	-
406/407CVX Wall Stop w/Plastic Anchor Convex Rubber, with drywall and masonry anchors. 	Brass	WS406/407CVX US3	605	1.8	-	1	10	4.60	-
		WS406/407CVX US4**	606	1.8	-	1	10	4.60	-
		WS406/407CVX US5	609	1.8	-	1	10	5.20	-
		WS406/407CVX US10**	612	1.8	-	1	10	5.20	-
		WS406/407CVX US10B**	613	1.8	-	1	10	5.20	-
		WS406/407CVX US15**	619	1.8	-	1	10	5.20	-
		WS406/407CVX US26**	625	1.8	-	1	10	5.20	-
		WS406/407CVX US26D**	626	1.8	-	1	10	4.60	-
		WS406/407CVX 643E/716**	-	1.8	-	1	10	5.20	-
		WS406/407CVX BLK**	622	1.8	-	1	10	5.20	-
Stainless	WS406/407CVX US32D**	630	1.8	-	1	10	3.70	-	
406/407CCV Wall Stop w/Plastic Anchor Concave Rubber, with drywall and masonry anchors. 	Brass	WS406/407CCV US3**	605	2.0	-	1	10	4.60	-
		WS406/407CCV US4**	606	2.0	-	1	10	4.60	-
		WS406/407CCV US5	609	1.8	-	1	10	5.20	-
		WS406/407CCV US10**	612	2.0	-	1	10	5.20	-
		WS406/407CCV US10B**	613	2.0	-	1	10	5.20	-
		WS406/407CCV US15**	619	2.0	-	1	10	5.20	-
		WS406/407CCV US26**	625	2.0	-	1	10	5.20	-
		WS406/407CCV US26D**	626	2.0	-	1	10	4.60	-
		WS406/407CCV 643E/716**	-	2	-	1	10	5.20	-
		WS406/407CCV BLK**	622	2	-	1	10	5.20	-
Stainless	WS406/407CCV US32D**	630	2.0	-	1	10	3.70	-	

Lead time exception: ** Products are stocked and will typically ship within 3 days







Bold pricing indicates item is in stock and available for **Fast Track** and **ProXpress**

MODEL	SUBSTRATE	MODEL NUMBER	BHMA FINISH	WEIGHT	MUST BE ORDERED IN MULTIPLE QTY	MULTIPLE QTY	PACKED PER BOX	LIST PRICE	
								EACH	PACKAGE
FS410 Universal Floor Dome Stop		FS410 US3	605	3.0		1		\$31.50	-
		FS410 US15	619	3.0		1		26.60	-
		FS410 US26	625	3.0		1		26.60	-
		FS410 US26D**	626	3.0		1		26.60	-
		FS410 643E/716 **	-	3.0		1		26.60	-
		FS410 BLK**	622	3.0		1		26.60	-
411 Wall Stop Adhesive Back	Rubber	411R-W**	-	1.1	-	1	20	3.40	-
430 Floor Door Stop 	Aluminum	SP430A3	666	1.9	Yes	25	25	-	79.25
		SP430A5	-	1.9	Yes	25	25	-	82.50
		SP430A14	669	1.9	Yes	25	25	-	82.50
		SP430A92	673	1.9	Yes	25	25	-	79.25
	Brass	430 US3	605	1.8	-	1	10	18.00	-
		430 US4	606	1.8	-	1	10	16.60	-
		430 US5	609	1.8	-	1	10	21.20	-
		430 US10B	613	1.8	-	1	10	21.20	-
		430 US15	619	1.8	-	1	10	22.30	-
		430 US26	625	1.8	-	1	10	21.20	-
430 US26D		626	1.8	-	1	10	21.20	-	
430 Rubber Tip	Rubber	RT (WSPART.1075)	-	-	Yes	100	100	-	97.00
FS434 Angle Door Stop	Steel	FS434 US2C**	604	4.0	-	1	10	10.40	-
FS434 Rubber Tip		09-318	-	-	-	1	1	4.90	-
R435 Riser For 436 Door Stop 	Aluminum	R435 1/4 IN**	-	2.1	-	1	20	7.30	-
		R435 3/8 IN	-	2.6	-	1	20	7.30	-
		R435 1/2 IN	-	2.9	-	1	20	7.30	-
		R435 5/8 IN	-	3.3	-	1	20	7.30	-
		R435 3/4 IN	-	3.2	-	1	20	7.30	-
		R435 7/8 IN	-	3.2	-	1	20	7.30	-
		R435 1 IN	-	3.1	-	1	20	7.30	-
FS436 Floor Dome Stop 1" Height 	Brass	FS436 US3**	605	2.2	-	1	10	7.70	-
		FS436 US4**	606	2.2	-	1	10	7.70	-
		FS436 US5	609	2.2	-	1	10	7.70	-
		FS436 US10**	612	2.2	-	1	10	8.80	-
		FS436 US10B**	613	2.2	-	1	10	8.80	-
		FS436 US15**	619	2.2	-	1	10	8.80	-
		FS436 US26**	625	2.2	-	1	10	8.00	-
		FS436 US26D**	626	2.2	-	1	10	6.40	-
		FS436 643E/716**	-	2.2	-	1	10	8.70	-
		FS436 BLK**	622	2.2	-	1	10	8.70	-
	SPFS436US26D	626	2.5	Yes	10	10	-	64.60	
	Aluminum	FS436 US28**	628	-	-	1	10	5.90	-
		SPFS436US28	628	-	Yes	15	15	-	88.20
R437 Riser For 438 Door Stop 	Aluminum	R437 1/4 IN	-	2.0	-	1	10	7.80	-
		R437 3/8 IN	-	2.0	-	1	10	7.80	-
		R437 1/2 IN	-	2.0	-	1	10	7.80	-
		R437 5/8 IN	-	2.0	-	1	10	7.80	-
		R437 3/4 IN	-	2.2	-	1	10	7.80	-
		R437 1 IN	-	2.3	-	1	10	7.80	-

HINGES
 CONTINUOUS HINGES
 PIVOTS
 Numerical 1-059
 Numerical 59-437
 Numerical 438-1021
 Numerical 1152-8190
 Numerical 8200-9266







Lead time exception: ** Products are stocked and will typically ship within 3 days

Bold pricing indicates item is in stock and available for **Fast Track** and **ProXpress**

MODEL	SUBSTRATE	MODEL NUMBER	BHMA FINISH	WEIGHT	MUST BE ORDERED IN MULTIPLE QTY	MULTIPLE QTY	PACKED PER BOX	LIST PRICE	
								EACH	PACKAGE
FS438 Floor Dome Stop 13/8" Height 	Brass	FS438 US3	605	2.7	-	1	10	\$9.20	-
		FS438 US4	606	2.7	-	1	10	9.20	-
		FS438 US5	609	2.7	-	1	10	9.20	-
		FS438 US10	612	2.7	-	1	10	10.40	-
		FS438 US10B**	613	2.7	-	1	10	10.40	-
		FS438 US15**	619	2.7	-	1	10	13.20	-
		FS438 US26**	625	2.7	-	1	10	9.80	-
		FS438 US26D**	626	2.7	-	1	10	7.20	-
		FS438 643E/716	-	2.7	-	1	10	10.40	-
	FS438 BLK**	622	2.7	-	1	10	10.40	-	
	Aluminum	FS438 US28**	628	1.6	-	1	10	7.10	-
FS439 	Zinc	FS439 US3	677	2.2	-	1	10	13.40	-
		FS439 US4	678	2.2	-	1	10	13.40	-
		FS439 US10B**	704	2.2	-	1	10	14.50	-
		FS439 US15	-	2.2	-	1	10	13.40	-
		FS439 US26	681	2.2	-	1	10	14.50	-
		FS439 US26D**	682	2.2	-	1	10	11.90	-
		FS439 643E/716	-	2.2	-	1	10	14.50	-
		FS439 BLK**	676	2.2	-	1	10	14.50	-
		Stainless	FS439 US32D**	630	2.2	-	1	10	19.40
FS441 Floor Stop Now furnished with wood and masonry fasteners 	Brass	FS441 US3	605	1.1	-	1	2	26.60	-
		FS441 US4	606	1.1	-	1	2	30.50	-
		FS441 US5	609	1.1	-	1	2	28.50	-
		FS441 US10	612	1.1	-	1	2	30.50	-
		FS441 US10B**	613	1.1	-	1	2	28.50	-
		FS441 US15	619	1.1	-	1	2	36.70	-
		FS441 US26	625	1.1	-	1	2	36.70	-
		FS441 US26D**	626	1.1	-	1	2	25.90	-
		FS441 643E/716	-	1.1	-	1	2	36.70	-
	FS441 BLK**	622	1.1	-	1	2	28.50	-	
FS441 Rubber Tip		09-315	-	-	-	1	1	2.60	-
WS443 Wall Door Stop for Masonry Mounting 	Brass	WS443 US3	605	1.5	-	1	2	41.40	-
		WS443 US4	606	1.5	-	1	2	51.60	-
		WS443 US10	612	1.5	-	1	2	49.80	-
		WS443 US10B	613	1.5	-	1	2	49.80	-
		WS443 US15	619	1.5	-	1	2	51.60	-
		WS443 US26	625	1.5	-	1	2	49.80	-
		WS443 US26D**	626	1.5	-	1	2	49.80	-
		WS443 643E/716	-	1.5	-	1	2	51.60	-
	WS443 BLK	622	1.5	-	1	2	49.80	-	
WS443 Rubber Tip		09-316	-	-	-	1	1	2.60	-
FS444 Floor Stop for Masonry Mounting 	Brass	FS444 US3	605	2.0	-	1	2	31.60	-
		FS444 US4	606	2.0	-	1	2	31.60	-
		FS444 US10	612	2.0	-	1	2	31.60	-
		FS444 US10B**	613	2.0	-	1	2	37.20	-
		FS444 US15**	619	2.0	-	1	2	40.50	-
		FS444 US26	625	2.0	-	1	2	31.60	-
		FS444 US26D**	626	2.0	-	1	2	30.50	-
		FS444 643E/716	-	2.0	-	1	2	37.20	-
	FS444 BLK**	622	2.0	-	1	2	31.60	-	
FS444 Rubber Tip		09-316	-	-	-	1	1	2.60	-
WS445 Wall Door Stop w/Heavy Duty Holder for Masonry Mounting 	Brass	WS445 US3	605	1.9	-	1	2	65.60	-
		WS445 US4	606	1.9	-	1	2	78.80	-
		WS445 US10	612	1.9	-	1	2	78.80	-
		WS445 US10B	613	1.9	-	1	2	78.80	-
		WS445 US15	619	1.9	-	1	2	82.00	-
		WS445 US26	625	1.9	-	1	2	78.80	-
		WS445 US26D**	626	1.9	-	1	2	78.80	-
		WS445 643E/716	-	1.9	-	1	2	82.00	-
	WS445 BLK	622	1.9	-	1	2	78.80	-	
WS445 Rubber Tip		09-316	-	-	-	1	1	2.60	-
FS446 Floor Stop w/Heavy Duty Holder for Masonry Mounting 	Brass	FS446 US3	605	2.4	-	1	2	62.60	-
		FS446 US4	606	2.4	-	1	2	62.60	-
		FS446 US10	612	2.4	-	1	2	62.60	-
		FS446 US10B**	613	2.4	-	1	2	55.70	-
		FS446 US15	619	2.4	-	1	2	57.90	-
		FS446 US26	625	2.4	-	1	2	62.60	-
		FS446 US26D**	626	2.4	-	1	2	44.50	-
		FS446 643E/716	-	2.4	-	1	2	62.60	-
	FS446 BLK	622	2.4	-	1	2	62.60	-	
		Aluminum	FS446 US28	628	1.3	-	1	2	32.00
FS446 Rubber Tip		09-316	-	-	-	1	1	2.60	-

Lead time exception: ** Products are stocked and will typically ship within 3 days







Bold pricing indicates item is in stock and available for **Fast Track** and **ProXpress**

MODEL	SUBSTRATE	MODEL NUMBER	BHMA FINISH	WEIGHT	MUST BE ORDERED IN MULTIPLE QTY	MULTIPLE QTY	PACKED PER BOX	LIST PRICE	
								EACH	PACKAGE
WS447 Heavy Duty Wall Door Stop for Drywall Mounting 	Brass	WS447 US3	605	1.3	-	1	2	\$37.60	-
		WS447 US4	606	1.3	-	1	2	45.20	-
		WS447 US10	612	1.3	-	1	2	45.20	-
		WS447 US10B	613	1.3	-	1	2	45.20	-
		WS447 US15	619	1.3	-	1	2	47.00	-
		WS447 US26	625	1.3	-	1	2	45.20	-
		WS447 US26D**	626	1.3	-	1	2	45.20	-
		WS447 643E/716	-	1.3	-	1	2	37.80	-
		WS447 BLK	622	1.3	-	1	2	36.30	-
WS447 Rubber Tip		09-316	-	-	-	1	1	2.60	-
FS448 Floor Door Stop Heavy Duty for Wood Mounting 	Brass	FS448 US3	605	1.9	-	1	2	35.50	-
		FS448 US4	606	1.9	-	1	2	35.50	-
		FS448 US5	609	1.9	-	1	2	41.20	-
		FS448 US10	612	1.9	-	1	2	35.50	-
		FS448 US10B**	613	1.9	-	1	2	34.30	-
		FS448 US15	619	1.9	-	1	2	44.50	-
		FS448 US26	625	1.9	-	1	2	44.50	-
		FS448 US26D**	626	1.9	-	1	2	35.50	-
		FS448 643E/716	-	1.9	-	1	2	44.50	-
		FS448 BLK	622	1.9	-	1	2	44.50	-
	Aluminum	FS448 US28	628	0.8	-	1	2	26.00	-
FS448 Rubber Tip		09-316	-	-	-	1	1	2.60	-
WS449 Wall Door Stop w/Heavy Duty Holder for Drywall Mounting 	Brass	WS449 US3	605	1.6	-	1	2	62.70	-
		WS449 US4	606	1.6	-	1	2	75.20	-
		WS449 US10	612	1.6	-	1	2	75.20	-
		WS449 US10B	613	1.6	-	1	2	75.20	-
		WS449 US15	619	1.6	-	1	2	78.20	-
		WS449 US26	625	1.6	-	1	2	75.20	-
		WS449 US26D**	626	1.6	-	1	2	75.20	-
		WS449 643E/716	-	1.6	-	1	2	78.20	-
		WS449 BLK	622	1.6	-	1	2	75.20	-
	Aluminum	WS449 US28	628	0.9	-	1	2	52.50	-
WS449 Rubber Tip		09-316	-	-	-	1	1	2.60	-
FS450 Floor Door Stop w/Heavy Duty Holder for Wood Mounting 	Brass	FS450 US3	605	2.2	-	1	2	66.60	-
		FS450 US4	606	2.2	-	1	2	66.60	-
		FS450 US10	612	2.2	-	1	2	66.60	-
		FS450 US10B	613	2.2	-	1	2	66.60	-
		FS450 US15	619	2.2	-	1	2	70.70	-
		FS450 US26	625	2.2	-	1	2	66.60	-
		FS450 US26D**	626	2.2	-	1	2	48.50	-
		FS450 643E/716	-	2.20	-	1	2	70.70	-
		FS450 BLK	622	2.2	-	1	2	66.60	-
	Aluminum	FS450 US28	628	1.1	-	1	2	36.00	-
FS450 Rubber Tip		09-316	-	-	-	1	1	2.60	-
FS452 Kick Down Door Holder 4" 	Brass	FS452-4 US3	605	5.0	-	1	10	34.30	-
		FS452-4 US4	606	5.0	-	1	10	34.30	-
		FS452-4 US10	612	5.0	-	1	10	34.30	-
		FS452-4 US10B**	613	5.0	-	1	10	36.20	-
		FS452-4 US15	619	5.0	-	1	10	46.90	-
		FS452-4 US26	625	5.0	-	1	10	50.90	-
		FS452-4 US26D**	626	5.0	-	1	10	33.00	-
		FS452-4 643E/716	-	5.0	-	1	10	46.90	-
	FS452-4 BLK	622	5.0	-	1	10	36.20	-	
Aluminum	FS452-4 US28	628	2.1	-	1	10	29.80	-	
FS452 Rubber Tips		HRT (FSPART.1075)	-	-	Yes	100	100	-	\$142.90
FS452 Kick Down Door Holder 5" 	Brass	FS452-5 US3	605	5.8	-	1	10	47.40	-
		FS452-5 US4	606	5.8	-	1	10	47.40	-
		FS452-5 US10	612	5.8	-	1	10	47.40	-
		FS452-5 US10B**	613	5.8	-	1	10	47.40	-
		FS452-5 US15	619	5.8	-	1	10	53.50	-
		FS452-5 US26	625	5.8	-	1	10	59.50	-
		FS452-5 US26D**	626	5.8	-	1	10	40.90	-
		FS452-5 643E/716	-	5.8	-	1	10	53.50	-
	FS452-5 BLK	622	5.8	-	1	10	47.40	-	
FS452 Rubber Tips		HRT (FSPART.1075)	-	-	Yes	100	100	-	142.90
SB453 Surface Bolt UL Listed 8" 	Steel	SB453US2C-8-TB**	604	5.4	-	1	5	46.50	-
		SB453US3-8-TB	632	5.8	-	1	5	46.50	-
		SB453US4-8-TB	633	5.8	-	1	5	46.50	-
		SB453US10-8-TB	639	5.4	-	1	5	56.10	-
		SB453US10B-8-TB**	640	5.4	-	1	5	60.20	-
		SB453US15-8-TB	646	5.4	-	1	5	60.20	-
		SB453US26D-8-TB	652	5.4	-	1	5	57.30	-
		SB453643E/716-8-TB	-	5.4	-	1	5	60.20	-
SB453BLK-8-TB	-	5.8	-	1	5	46.50	-		

Lead time exception: ** Products are stocked and will typically ship within 3 days







Bold pricing indicates item is in stock and available for **Fast Track** and **ProXpress**

HINGES
 CONTINUOUS HINGES
 PIVOTS
 Numerical 1-059
 Numerical 59-437
 Numerical 438-1021
 Numerical 1152-8190
 Numerical 8200-9266

MODEL	SUBSTRATE	MODEL NUMBER	BHMA FINISH	WEIGHT	MUST BE ORDERED IN MULTIPLE QTY	MULTIPLE QTY	PACKED PER BOX	LIST PRICE	
								EACH	PACKAGE
SB453 Surface Bolt UL Listed 12"	Steel	SB453US2C 12-TB	604	6.6	-	1	5	\$58.70	-
		SB453US10 12-TB	639	6.6	-	1	5	62.70	-
		SB453US10B 12-TB**	640	6.6	-	1	5	68.40	-
		SB453US15 12-TB	646	6.6	-	1	5	72.40	-
		SB453US26D 12-TB**	652	6.6	-	1	5	72.40	-
		SB453643E/716 12-TB	-	6.6	-	1	5	72.40	-
		SB453BLK 12-TB	-	6.6	-	1	5	72.40	-
SB453 Thrubolt with Cap Nut Pkg		09-340-626	626	-	-	1	1	9.90	-
SB453 Sex Bolt Pkg		09-351-604	604	-	-	1	1	18.20	-
FS455 4" Kick Down Door Holder 	Aluminum	FS455-4 US3AL	666	1.9	-	1	10	9.30	-
		FS455-4 US5AL	-	2.0	-	1	10	13.70	-
		FS455-4 US10AL	668	1.9	-	1	10	9.30	-
		FS455-4 US27**	673	1.9	-	1	10	9.30	-
		SPFS455-4 US3AL	666	46.5	Yes	15	15	-	137.40
		SPFS455-4 US5AL	-	46.5	Yes	15	15	-	208.80
		SPFS455-4 US27	673	46.5	Yes	15	15	-	137.40
	Brass	FS455-4 US3	605	4.6	-	1	10	37.20	-
		FS455-4 US4	606	4.6	-	1	10	37.20	-
		FS455-4 US5	609	4.6	-	1	10	44.70	-
		FS455-4 US10	612	4.6	-	1	10	37.20	-
		FS455-4 US10B**	613	4.6	-	1	10	44.70	-
		FS455-4 US15	619	4.6	-	1	10	45.80	-
		FS455-4 US26	625	4.6	-	1	10	44.70	-
		FS455-4 US26D**	626	4.6	-	1	10	44.70	-
FS455-4 643E/716		-	4.6	-	1	10	45.80	-	
FS455-4 BLK	622	4.6	-	1	10	44.70	-		
FS455 Rubber Tips		HRT (FSPART.1075)	-	-	Yes	100	100	-	142.90
FB457 Manual Flush Bolt UL 3 Hour Single Metal Door  Accessory Rod Lengths Available** 18", 24", 36", 48" 7.10 List Price	Brass	FB457-12 US3	605	2.0	-	1	12	32.00	-
		FB457-12 US4	606	2.0	-	1	12	32.00	-
		FB457-12 US10	612	2.0	-	1	12	32.00	-
		FB457-12 US10B	613	2.0	-	1	12	32.00	-
		FB457-12 US15	619	2.0	-	1	12	32.00	-
		FB457-12 US26	625	2.0	-	1	12	32.00	-
		FB457-12 US26D**	626	2.0	-	1	12	32.00	-
		FB457-12 643E/716	-	2.0	-	1	12	32.00	-
		FB457-12 BLK	622	2.0	-	1	12	32.00	-
		FB457 Bolt Tips		09-176-604	-	-	-	1	1
FB457 Guide PKG		09-135	-	-	-	1	1	2.60	-
FB458 Manual Flush Bolt UL 3 Hour Single Metal Door  Accessory Rod Lengths Available** 18", 24", 36", 48" 7.10 List Price	Brass	FB458 US3 12 IN**	605	2.0	-	1	12	27.10	-
		FB458 US4 12 IN**	606	2.0	-	1	12	27.10	-
		FB458 US5 12 IN	609	2.0	-	1	12	27.10	-
		FB458 US10 12 IN**	612	2.0	-	1	12	27.10	-
		FB458 US10B 12 IN**	613	2.0	-	1	12	27.10	-
		FB458 US15 12 IN**	619	2.0	-	1	12	27.10	-
		FB458 US26 12 IN	625	2.0	-	1	12	27.10	-
		FB458 US26D 12 IN**	626	2.0	-	1	12	25.20	-
		FB458 643E/716 12 IN**	-	2.0	-	1	12	27.10	-
		FB458 BLK 12 IN**	622	2.0	-	1	12	27.10	-
FB458 Bolt Tips		09-176-604	604	-	-	1	1	5.90	-
FB458 Guide PKG		09-135	-	-	-	1	1	2.60	-
RB470 Roller Bumper 2" Reach 	Brass	RB470 US3	605	0.9	-	1	2	35.70	-
		RB470 US26	625	0.9	-	1	2	44.70	-
		RB470 US26D	626	0.9	-	1	2	44.70	-
RB470 Large Roller PKG		09-137-626	626	-	-	1	1	6.80	-
RB471 Roller Bumper 4-1/2" Projection 	Brass	RB471 US3	605	1.0	-	1	2	33.70	-
		RB471 US4	606	1.0	-	1	2	40.50	-
		RB471 US26	625	1.0	-	1	2	40.50	-
		RB471 US26D**	626	1.0	-	1	2	40.50	-
RB472 Roller Bumper 6" Projection 	Brass	RB472 US3	605	1.1	-	1	2	35.80	-
		RB472 US4	606	1.1	-	1	2	42.60	-
		RB472 US10	612	1.1	-	1	2	42.60	-
		RB472 US10B	613	1.1	-	1	2	42.60	-
		RB472 US15	619	1.1	-	1	2	40.60	-
		RB472 US26	625	1.1	-	1	2	42.60	-
RB472 US26D**	626	1.1	-	1	2	42.60	-		
RB472 Large Roller PKG		09-137-626	626	-	-	1	1	6.80	-

Lead time exception: ** Products are stocked and will typically ship within 3 days

Bold pricing indicates item is in stock and available for **Fast Track** and **ProXpress**

MODEL	SUBSTRATE	MODEL NUMBER	BHMA FINISH	WEIGHT	MUST BE ORDERED IN MULTIPLE QTY	MULTIPLE QTY	PACKED PER BOX	LIST PRICE	
								EACH	PACKAGE
481 Chain Door Guard 	Brass	481B3	605	2.5	-	1	10	13.00	-
		481B26D**	626	2.5	-	1	10	15.20	-
	Steel	481F3	632	2.3	-	1	10	7.20	-
		481F4	633	2.3	-	1	10	7.20	-
		481F5	638	2.3	-	1	10	8.10	-
		481F10	639	2.3	-	1	10	8.10	-
		481F15**	646	2.3	-	1	10	7.20	-
		481F26	651	2.3	-	1	10	7.20	-
		481F26D**	652	2.3	-	1	10	7.20	-
481F-643E/716**	-	1.2	-	1	10	8.30	-		
481F-BLK	631	2.3	-	1	10	8.10	-		
482 Door Guard 	Brass	482B3	605	5.0	-	1	5	35.90	-
		482B4	606	5.0	-	1	5	39.50	-
		482B10	612	5.0	-	1	5	39.50	-
		482B10B	613	5.0	-	1	5	39.50	-
		482B15	619	5.0	-	1	5	54.20	-
		482B26	625	5.0	-	1	5	39.50	-
		482B26D**	626	5.0	-	1	5	39.50	-
		482B643E/716	-	5.0	-	1	5	39.50	-
	482B-BLK	622	5.0	-	1	5	39.50	-	
	Zinc	482 Z605E	677	3.5	-	1	5	10.70	-
		482 Z609E	-	3.5	-	1	5	10.70	-
482 Z625E		681	3.5	-	1	5	12.70	-	
482 Z626E		682	3.5	-	1	5	12.70	-	
482 ▲ Plate		09-170-605	605	-	-	1	1	8.10	-
		09-170-613	613	-	-	1	1	8.10	-
		09-170-626	626	-	-	1	1	8.10	-
482 ▲ SHIM 1/8 In		09-576-626	626	-	-	1	1	18.50	-
482 ▲ SHIM 3/8 In		09-577-626	626	-	-	1	1	29.30	-
FS495 Auto Door Stop and Holder 3/8" Max Clearance Floor to Door 	Brass	FS495 US3	605	1.8	-	1	1	97.20	-
		FS495 US4	606	1.8	-	1	1	97.20	-
		FS495 US10	612	1.8	-	1	1	116.60	-
		FS495 US10B	613	1.8	-	1	1	116.60	-
		FS495 US26	625	1.8	-	1	1	116.60	-
		FS495 US26D**	626	1.8	-	1	1	97.20	-
FS496 Auto Door Stop and Holder 1" Max Clearance Floor to Door 	Brass	FS496 US3	605	1.5	-	1	1	111.00	-
		FS496 US10	612	1.5	-	-	1	111.00	-
		FS496 US10B	613	1.5	-	1	1	111.00	-
		FS496 US26	625	1.5	-	1	1	111.00	-
		FS496 US26D	626	1.5	-	1	1	111.00	-
FS497 Auto Door Stop and Holder 	Brass	FS497 US3	605	1.4	-	1	1	103.60	-
		FS497 US10	612	1.4	-	1	1	124.40	-
		FS497 US10B	613	1.4	-	1	1	124.40	-
		FS497 US26	625	1.4	-	1	1	124.40	-
		FS497 US26D	626	1.4	-	1	1	103.60	-
FS544 Kick Down Door Holder 4" 	Steel	FS544 SP4	706	-	-	1	-	13.70	-
		FS544 SPI0	691	-	-	1	-	13.70	-
		FS544 SP28**	689	-	-	1	-	13.70	-
		FS544 SP313**	695	-	-	1	-	13.70	-
		FS544 BLK	-	-	-	1	-	13.70	-
FS555 Kick Down Door Holder 5" 	Steel	FS555 SP4	706	-	-	1	-	14.70	-
		FS555 SPI0	691	-	-	1	-	14.70	-
		FS555 SP28**	689	-	-	1	-	14.70	-
		FS555 SP313	695	-	-	1	-	14.70	-
		FS555 BLK	-	-	-	1	-	14.70	-

▲ Fits brass door guards only.

Lead time exception: ** Products are stocked and will typically ship within 3 days

Bold pricing indicates item is in stock and available for **Fast Track** and **ProXpress**

HINGES

CONTINUOUS HINGES

PIVOTS









Numerical 1-059

Numerical 59-437

Numerical 438-1021



Numerical 1152-8190

Numerical 8200-9266

MODEL	SUBSTRATE	MODEL NUMBER	BHMA FINISH	WEIGHT	MUST BE ORDERED IN MULTIPLE QTY	MULTIPLE QTY	PACKED PER BOX	LIST PRICE	
								EACH	PACKAGE
506 Plymouth, Curved Double Coat Hook - Surface Mount 	Brass	506-605	605	-	-	1	20	\$13.10	-
		506-613	613	-	-	1	20	13.10	-
		506-625	625	-	-	1	20	13.10	-
		506-626	626	-	-	1	20	10.50	-
		506-643E/716	-	-	-	1	20	13.10	-
		506-BLK	622	-	-	1	20	13.10	-
507 Rhodes, Parallel Double Coat Hook - Surface Mount 	Brass	507-605	605	-	-	1	20	30.20	-
		507-613	613	-	-	1	20	31.70	-
		507-625	625	-	-	1	20	31.70	-
		507-626**	626	-	-	1	20	25.00	-
		507-643E/716	-	-	-	1	20	31.70	-
		507-BLK	622	-	-	1	20	31.70	-
507B Rhodes Single Coat Hook - Surface Mount	Brass	507B-605	605	-	-	1	50	30.20	-
		507B-613	613	-	-	1	50	31.70	-
		507B-625	625	-	-	1	50	31.70	-
		507B-626	626	-	-	1	50	25.00	-
		507B-643E/716	-	-	-	1	50	31.70	-
		507B-BLK	622	-	-	1	50	31.70	-
508 Greenwich, Wide Body Double Coat Hook - Surface Mount 	Brass	508-605	605	-	-	1	8	80.40	-
		508-613	613	-	-	1	8	83.00	-
		508-625	625	-	-	1	8	83.00	-
		508-626	626	-	-	1	8	64.60	-
		508-643E/716	-	-	-	1	8	83.00	-
		508-BLK	622	-	-	1	8	83.00	-
508C Greenwich, Wide Body Double Coat Hook - Concealed Mount 	Brass	508C-605	605	-	-	1	8	156.80	-
		508C-613	613	-	-	1	8	163.50	-
		508C-625	625	-	-	1	8	125.10	-
		508C-626	626	-	-	1	8	163.50	-
		508C-643E/716	-	-	-	1	8	163.50	-
		508C-BLK	622	-	-	1	8	158.70	-
509C Tubular, Double Coat Hook - Concealed Mount 	Brass	509C-605	605	-	-	1	5	131.70	-
		509C-613	613	-	-	1	5	137.10	-
		509C-625	625	-	-	1	5	137.10	-
		509C-626	626	-	-	1	5	105.20	-
		509C-643E/716	-	-	-	1	5	137.10	-
		509C-BLK	622	-	-	1	5	137.10	-
510C Latitude, Angled Double Coat Hook - Concealed Mount 	Brass	510C-605	605	-	-	1	4	131.70	-
		510C-613	613	-	-	1	4	137.10	-
		510C-625	625	-	-	1	4	137.10	-
		510C-626	626	-	-	1	4	105.20	-
		510C-643E/716	-	-	-	1	4	137.10	-
		510C-BLK	622	-	-	1	4	137.10	-
510BC Latitude, Angled Single Coat Hook - Concealed Mount 	Brass	510BC-605	605	-	-	1	8	93.40	-
		510BC-613	613	-	-	1	8	97.60	-
		510BC-625	625	-	-	1	8	97.60	-
		510BC-626	626	-	-	1	8	75.10	-
		510BC-643E/716	-	-	-	1	8	97.60	-
		510BC-BLK	622	-	-	1	8	97.60	-
511BC Century, Wide Single Coat Hook - Concealed Mount	Brass	511BC-605	605	-	-	1	50	22.50	-
		511BC-613	613	-	-	1	50	22.50	-
		511BC-625	625	-	-	1	50	22.50	-
		511BC-626	626	-	-	1	50	17.10	-
		511BC-643E/716	-	-	-	1	50	22.50	-
		511BC-BLK	622	-	-	1	50	22.50	-
543 Camelot, J Curve, Double Coat Hook - Surface Mount 	Stainless	543-629	629	-	-	1	10	11.90	-
		543-630**	630	-	-	1	10	11.90	-
543B Camelot, J Curve, Single Coat Hook - Surface Mount	Stainless	543B-629	629	-	-	1	10	10.50	-
		543B-630	630	-	-	1	10	10.50	-
554 Century, Wave Double Coat Hook - Surface Mount	Brass	554-605	605	-	-	1	10	32.90	-
		554-619	619	-	-	1	10	32.90	-
		554-625	625	-	-	1	10	26.30	-
		554-626	626	-	-	1	10	26.30	-
		554-643E/716	-	-	-	1	10	32.90	-
		554-BLK	622	-	-	1	10	32.90	-

Lead time exception: ** Products are stocked and will typically ship within 3 days

Bold pricing indicates item is in stock and available for **Fast Track** and **ProXpress**





MODEL	SUBSTRATE	MODEL NUMBER	BHMA FINISH	WEIGHT	MUST BE ORDERED IN MULTIPLE QTY	MULTIPLE QTY	PACKED PER BOX	LIST PRICE	
								EACH	PACKAGE
558B Orbit 1" J Curve w/ Bumper Single Coat Hook - Surface Mount	Brass	558B-605	605	-	-	1	20	\$108.00	-
		558B-613	613	-	-	1	20	113.30	-
		558B-619	619	-	-	1	20	108.00	-
		558B-625	625	-	-	1	20	113.30	-
		558B-626	626	-	-	1	20	86.80	-
		558B-643E/716	-	-	-	1	20	113.30	-
		558B-BLK	622	-	-	1	20	108.00	-
559B Tubular, w/ Disc Single Coat Hook - Surface Mount	Brass	559B-605	605	-	-	1	40	25.00	-
		559B-613	613	-	-	1	40	25.00	-
		559B-619	619	-	-	1	40	25.00	-
		559B-625	625	-	-	1	40	25.00	-
		559B-626	626	-	-	1	40	19.90	-
		559B-643E/716	-	-	-	1	40	25.00	-
571 Coat and Hat Hook 	Aluminum	571A3**	666	1.3	-	1	20	1.40	-
		571A5	-	1.3	-	1	20	2.10	-
		571A10	668	1.3	-	1	20	1.40	-
		571A14**	669	1.3	-	1	20	2.10	-
		571A15**	670	1.3	-	1	20	2.10	-
		571A26	672	1.3	-	1	20	2.10	-
		571A26D**	702	1.3	-	1	20	1.90	-
		571A92**	673	1.3	-	1	20	1.40	-
		571A-643E/716**	-	1.3	-	1	20	2.80	-
		571A-BLK**	-	1.4	-	1	20	2.80	-
		571A-W	-	1.4	-	1	20	2.80	-
		SP571A3	666	47.5	Yes	25	25	-	36.75
		SP571A5	-	47.5	Yes	25	25	-	50.25
		SP571A14	669	47.5	Yes	25	25	-	51.75
	SP571A92**	673	47.5	Yes	25	25	-	36.75	
	SP571A-W	-	47.5	Yes	25	25	-	70.25	
	Brass	571B3	605	1.5	-	-	10	9.40	-
		571B4	606	1.5	-	-	10	11.00	-
		571B5	609	1.5	-	-	10	11.00	-
		571B10B	613	1.5	-	1	10	11.00	-
		571B15**	619	1.5	-	1	10	11.60	-
571B26		625	1.5	-	1	10	11.00	-	
571B26D**		626	1.5	-	1	10	11.00	-	
571B-643E/716		-	1.5	-	1	10	11.00	-	
571B-BLK		622	1.5	-	1	10	11.00	-	
SP571B26		625	24	Yes	10	10	-	115.00	
572 Coat and Hat Hook 	Aluminum	572A3	666	1.9	-	1	20	4.60	-
		572A5	-	1.9	-	1	20	4.80	-
		572A10	668	1.9	-	1	20	4.80	-
		572A10B	703	0.0	-	1	20	4.80	-
		572A14	669	1.9	-	1	20	4.80	-
		572A15**	670	1.9	-	1	20	4.80	-
		572A92**	673	1.9	-	1	20	4.60	-
	Brass	572B3	605	1.1	-	1	10	12.70	-
		572B4	606	1.1	-	1	10	12.70	-
		572B5	609	1.1	-	1	10	15.90	-
		572B10	612	1.1	-	1	10	12.70	-
		572B10B	613	1.1	-	1	10	15.30	-
		572B15	619	1.1	-	1	10	15.90	-
		572B26	625	1.1	-	1	10	15.30	-
572B26D**	626	1.1	-	1	10	15.30	-		

HINGES
 CONTINUOUS HINGES
 PIVOTS
 Numerical 1-059
 Numerical 59-437
 Numerical 438-1021
 Numerical 1152-8190
 Numerical 8200-9266

Lead time exception: ** Products are stocked and will typically ship within 3 days

Bold pricing indicates item is in stock and available for **Fast Track** and **ProXpress**





HINGES
 CONTINUOUS HINGES
 PIVOTS
 Numerical 1-059
 Numerical 59-437
 Numerical 438-1021
 Numerical 1152-8190
 Numerical 8200-9266

MODEL	SUBSTRATE	MODEL NUMBER	BHMA FINISH	WEIGHT	MUST BE ORDERED IN MULTIPLE QTY	MULTIPLE QTY	PACKED PER BOX	LIST PRICE	
								EACH	PACKAGE
574 Coat and Hat Hook 	Aluminum	574A3	666	1.6	-	1	10	\$9.30	-
		574A26	672	1.6	-	1	10	9.30	-
		574A92	673	0.0	-	1	10	9.30	-
	Brass	574B3	605	4.1	-	1	10	31.70	-
		574B4	606	0.0	-	1	10	31.70	-
		574B10	612	0.0	-	1	10	37.90	-
		574B10B	613	4.1	-	1	10	37.90	-
		574B15	619	0.0	-	1	10	41.70	-
		574B26	625	4.1	-	1	10	37.90	-
574B26D**	626	4.1	-	1	10	37.90	-		
575 Coat and Hat Hook 	Aluminum	575A3	666	1.4	-	1	10	5.60	-
		575A10B	703	1.4	-	1	10	6.20	-
		575A92**	673	1.4	-	1	10	5.60	-
580 Ceiling Hook 	Aluminum	580A3	666	1.8	-	1	20	3.20	-
		580A5**	-	0.0	-	1	20	3.40	-
		580A10	668	1.8	-	1	20	3.40	-
		580A14	669	1.8	-	1	20	3.40	-
		580A15**	670	0.0	-	1	20	3.40	-
		580A26	672	1.8	-	1	20	3.40	-
		580A26D	702	1.8	-	1	20	3.40	-
		580A92**	673	1.8	-	1	20	3.20	-
		580A-643E/716**	-	0.0	-	1	20	3.40	-
		580A-BLK	-	0.0	-	1	20	3.40	-
		SP580A14	669	60.0	Yes	25	25	-	86.75
		SP580A3	666	60.0	Yes	25	25	-	80.25
SP580A92	673	60.0	Yes	25	25	-	80.25		
581 Wardrobe Hook 	Aluminum	581A3**	666	0.9	-	1	20	1.90	-
		581A5	-	0.9	-	1	20	2.10	-
		581A14**	669	0.8	-	1	20	2.10	-
		581A15**	670	0.9	-	1	20	2.10	-
		581A26	672	0.9	-	1	20	2.10	-
		581A26D**	702	0.9	-	1	20	2.10	-
		581A92**	673	0.90	-	1	20	1.90	-
		581A-643E/716**	-	0.90	-	1	20	2.10	-
		581A-BLK	-	0.90	-	1	20	2.70	-
		581A-W	-	0.90	-	1	20	2.70	-
		SP581A3	666	120.0	Yes	50	50	-	87.50
		SP581A5	-	120.0	Yes	50	50	-	100.50
		SP581A14	669	120.0	Yes	50	50	-	100.50
	SP581A92**	673	2.4	Yes	50	50	-	87.50	
	Brass	581B3	605	0.8	-	1	10	6.30	-
		581B4	606	0.0	-	1	10	6.70	-
		581B5	609	0.8	-	1	10	7.60	-
		581B10	612	0.0	-	1	10	7.70	-
		581B10B	613	0.8	-	1	10	7.60	-
		581B15**	619	0.8	-	1	10	7.80	-
581B26		625	0.8	-	1	10	7.60	-	
581B26D**	626	0.8	-	1	10	7.60	-		
581B-643E/716	-	-	-	1	10	7.80	-		
581B-BLK	622	-	-	1	10	7.60	-		

Continued on next page.

Lead time exception: ** Products are stocked and will typically ship within 3 days

Bold pricing indicates item is in stock and available for **Fast Track** and **ProXpress**

MODEL	SUBSTRATE	MODEL NUMBER	BHMA FINISH	WEIGHT	MUST BE ORDERED IN MULTIPLE QTY	MULTIPLE QTY	PACKED PER BOX	LIST PRICE	
								EACH	PACKAGE
581 Wardrobe Hook <i>Continued from previous page.</i> 	Brass	SP581B26	625	27.0	Yes	10	10	-	\$74.90
	Zinc	581Z-619E	-	2.6	-	1	20	\$5.60	-
582 Wardrobe Hook 	Aluminum	582A3	666	1.0	-	1	20	2.10	-
		582A5	-	1.0	-	1	20	2.20	-
		582A10	668	1.0	-	1	20	2.20	-
		582A14**	669	1.0	-	1	20	2.20	-
		582A15**	670	1.0	-	1	20	2.20	-
		582A26	672	1.0	-	1	20	2.20	-
		582A26D**	702	1.0	-	1	20	2.20	-
		582A92**	673	1.0	-	1	20	2.10	-
		582A-643E/716	-	1.0	-	1	20	2.20	-
		582A-BLK**	-	1.0	-	1	20	2.90	-
		582A-W**	-	1.0	-	1	20	2.90	-
		SP582A3	666	42.5	Yes	25	25	-	50.25
		SP582A5	-	42.5	Yes	25	25	-	53.25
		SP582A14	669	42.5	Yes	25	25	-	53.25
	SP582A92**	673	42.5	Yes	25	25	-	50.25	
	SP582A-W	-	35.0	Yes	25	25	-	73.25	
	Brass	582B3	605	1.2	-	1	10	8.30	-
		582B4	606	1.2	-	1	10	9.40	-
		582B5	609	1.2	-	1	10	9.40	-
		582B10	612	1.2	-	1	10	10.00	-
582B10B**		613	1.2	-	1	10	10.00	-	
582B15**		619	1.2	-	1	10	10.30	-	
582B26		625	1.2	-	1	10	10.00	-	
582B26D**		626	1.2	-	1	10	10.00	-	
582B-643E/716**		-	1.2	-	1	10	10.30	-	
582B-BLK		622	1.2	-	1	10	10.00	-	
SP582B26	625	12.0	Yes	10	10	-	104.40		
Zinc	582Z-619E	-	4.7	-	1	20	5.60	-	
585/586 Closet Pole Socket 	Steel	SP585F3	632	50.0	Yes	25	25	-	43.25
	Plastic	SP586P**	-	32.0	Yes	20	20	-	27.40
601 Mail Slot Sleeve 	Brass	60113/4 IN**	630	0.4	-	1	1	21.30	-
620 Letter Box Plate Magazine Open Back Plate Spring-Loaded Front Plate 	Brass	620B3**	605	1.5	-	1	1	87.60	-
		620B5	609	1.5	-	1	1	108.00	-
		620B15	619	1.5	-	1	1	104.90	-
		620B26	625	1.5	-	1	1	104.90	-
		620B26D**	626	1.5	-	1	1	104.90	-
		620B-643E/716**	-	3.3	-	1	1	104.90	-
		620B-BLK	622	3.3	-	1	1	104.90	-
	Aluminum	620PA28**	628	0.6	-	1	1	54.60	-

HINGES
 CONTINUOUS HINGES
 PIVOTS
 Numerical 1-059
 Numerical 59-437
 Numerical 438-1021
 Numerical 1152-8190
 Numerical 8200-9266

Lead time exception: ** Products are stocked and will typically ship within 3 days

Bold pricing indicates item is in stock and available for **Fast Track** and **ProXpress**

HINGES

CONTINUOUS HINGES

PIVOTS



Numerical 1-059

Numerical 59-437

Numerical 438-1021



Numerical 1152-8190

Numerical 8200-9266

MODEL	SUBSTRATE	MODEL NUMBER	BHMA FINISH	WEIGHT	MUST BE ORDERED IN MULTIPLE QTY	MULTIPLE QTY	PACKED PER BOX	LIST PRICE	
								EACH	PACKAGE
620 Sex Bolt PKG		09-355-605	605	-	-	1	1	\$12.80	-
		09-355-613	613	-	-	1	1	15.40	-
		09-355-626	626	-	-	1	1	15.40	-
STK685 Double Acting Strike Custom Made Specify Jamb width when ordering	Brass	STK685 US3	605	-	-	1	-	329.00	-
		STK685 US4	606	-	-	1	-	329.00	-
		STK685 US10	612	-	-	1	-	329.00	-
		STK685 US10B	613	-	-	1	-	329.00	-
		STK685 US26	625	-	-	1	-	329.00	-
		STK685 US26D	626	-	-	1	-	329.00	-
STK685L Double Acting Strike, Custom Made Specify Dimple Location and Jamb Width when ordering	Brass	STK685L US3	605	-	-	1	-	329.00	-
		STK685L US4	606	-	-	1	-	329.00	-
		STK685L US10	612	-	-	1	-	329.00	-
		STK685L US10B	613	-	-	1	-	329.00	-
		STK685L US26	625	-	-	1	-	329.00	-
		STK685L US26D	626	-	-	1	-	329.00	-
U696 Door Viewer, 150° UL Listed 90 Min	Brass	U696B4	606	0.5	-	1	10	18.30	-
		U696B10B**	613	0.5	-	1	10	18.30	-
		U696B15	619	0.5	-	1	10	18.30	-
		U696B26	625	0.5	-	1	10	18.30	-
		U696B26D**	626	0.5	-	1	10	18.30	-
		U696B-643E/716	-	0.5	-	1	10	18.30	-
		U696B-BLK	622	0.5	-	1	10	18.30	-
696-700-701 Viewer Cover	Brass	890312606	606	-	-	1	1	2.20	-
		890312613	613	-	-	1	1	2.20	-
		890312619	619	-	-	1	1	2.20	-
		890312625	625	-	-	1	1	2.20	-
		890312626	626	-	-	1	1	2.20	-
		890312716	716	-	-	1	1	2.20	-
		890312622	622	-	-	1	1	2.20	-
696-700-701 Viewer Extension	Brass	890314626	626	-	-	1	1	3.30	-
698 Door Viewer, 190° For Doors 1-3/8" to 2-1/8" U = UL Listed 90 Min P = Plastic Lens 	Brass	698B3**	605	0.8	-	1	10	21.50	-
		698B26D**	626	0.8	-	1	10	21.50	-
		698P-B643E/716**	-	0.8	-	1	10	21.50	-
		U698B3**	605	0.8	-	1	10	25.80	-
		U698B15**	619	0.8	-	1	10	25.80	-
		U698B26	625	0.8	-	1	10	25.80	-
		U698B26D**	626	0.8	-	1	10	25.80	-
		U698B-643E/716**	-	0.8	-	1	10	25.80	-
		U698B-BLK**	622	0.8	-	1	10	25.80	-
698 Viewer Cover	Brass	890311605	605	-	-	1	1	2.80	-
		890311619	619	-	-	1	1	2.80	-
		890311625	625	-	-	1	1	2.80	-
		890311626**	626	-	-	1	1	2.80	-
		890311716	716	-	-	1	1	2.80	-
		890311622	622	-	-	1	1	2.80	-
698 Viewer Extension	Brass	890313626	626	-	-	1	1	4.50	-
700 Door Viewer, 120° For Doors 1-3/8" to 2-1/16" U = UL Listed 90 Min 	Brass	700B4	606	0.5	-	1	10	9.30	-
		700B26D**	626	0.5	-	1	10	9.30	-
		U700B4	606	0.5	-	1	10	12.60	-
		U700B10B	613	0.5	-	1	10	12.60	-
		U700B15**	619	0.5	-	1	10	12.60	-
		U700B26	625	0.5	-	1	10	12.60	-
		U700B26D**	626	0.5	-	1	10	12.60	-
		U700B-643E/716	-	0.5	-	1	10	12.60	-
U700B-BLK	622	0.5	-	1	10	12.60	-		
700 Trim Washer		09-241-606	606	-	-	1	1	0.30	-
		09-241-613	613	-	-	1	1	0.30	-
		09-241-626	626	-	-	1	1	0.30	-
701 Door Viewer, 120° For Doors 2-1/8" to 2-5/8" U = UL Listed 90 Min 	Brass	701B4	606	0.8	-	1	10	10.10	-
		701B10B	613	0.8	-	1	10	10.10	-
		701B26D	626	0.8	-	1	10	10.10	-
		U701B4	606	0.8	-	1	10	14.50	-
		U701B10B	613	0.8	-	1	10	14.50	-
		U701B15	619	0.8	-	1	10	14.50	-
		U701B26	625	0.8	-	1	10	14.50	-
		U701B26D	626	0.5	-	1	10	14.50	-
		U701B-643E/716	-	0.8	-	1	10	14.50	-
		U701B-BLK	622	0.8	-	1	10	14.50	-

Lead time exception: ** Products are stocked and will typically ship within 3 days







Bold pricing indicates item is in stock and available for Fast Track and ProXpress

MODEL	SUBSTRATE	MODEL NUMBER	BHMA FINISH	WEIGHT	MUST BE ORDERED IN MULTIPLE QTY	MULTIPLE QTY	PACKED PER BOX	LIST PRICE	
								EACH	PACKAGE
VR810DT/VR814DT Vandal Resistant Trim Use w/Falcon XX, 18 and 25 Series Exit Devices	Stainless	VR810-DT US32D	630	-	-	1	1	\$322.90	-
		VR814-DT US32D	630	-	-	1	1	322.90	-
VR810NL/VR814NL Vandal Resistant Trim Use w/Falcon XX, and 18 Series Rim Exit Devices	Stainless	VR810-NL RHR US32D	630	-	-	1	1	322.90	-
		VR810-NL LHR US32D	630	-	-	1	1	322.90	-
		VR814-NL RHR US32D	630	-	-	1	1	322.90	-
		VR814-NL LHR US32D	630	-	-	1	1	322.90	-
VR810NL-V/VR814NL-V Vandal Resistant Trim Use w/ Falcon XX-V, and w/ 25-R (Rim) and 25-V (surface vertical) devices	Stainless	VR810-NL-V US32D	630	-	-	1	1	322.90	-
		VR814-NL-V US32D	630	-	-	1	1	322.90	-
AS895 Applied Stop 	Brass	AS895 US3	605	-	-	1	1	58.40	-
		AS895 US4	606	-	-	1	1	53.80	-
		AS895 US10	612	-	-	1	1	54.40	-
		AS895 US10B	613	-	-	1	1	58.40	-
		AS895 US26	625	-	-	1	1	58.40	-
		AS895 US26D	626	-	-	1	1	58.40	-
VR900/VR904 Vandal Resistant Trim Use w/Mortise Locks Outswing Doors	Stainless	VR900 LHR US32D	630	-	-	1	1	322.90	-
		VR900 RHR US32D**	630	-	-	1	1	322.90	-
		VR904 LHR US32D	630	-	-	1	1	322.90	-
		VR904 RHR US32D	630	-	-	1	1	322.90	-
VR900LLP/VR904LLP Vandal Resistant Trim Use w/Mortise Locks Inswing Doors LLP = Less Lock Protectors	Stainless	VR900-LLP LH US32D	630	-	-	1	1	322.90	-
		VR900-LLP RH US32D	630	-	-	1	1	322.90	-
		VR904-LLP LH US32D	630	-	-	1	1	322.90	-
		VR904-LLP RH US32D	630	-	-	1	1	322.90	-
VR910DT/VR914DT Vandal Resistant Trim Use w/Von Duprin 98/99 Series Rim and Verticle Exit Devices	Stainless	VR910-DT US32D**	630	-	-	1	1	322.90	-
		VR914-DT US32D	630	-	-	1	1	322.90	-
VR910NL/VR914NL Vandal Resistant Trim Use w/Von Duprin 98/99 Series Rim and Verticle Exit Devices	Stainless	VR910-NL US32D**	630	-	-	1	1	322.90	-
		VR914-NL US32D	630	-	-	1	1	322.90	-
VR910M-DT/VR914M-DT Vandal Resistant Trim Use w/Von Duprin 98/9975 Series Mortise Exit Devices	Stainless	VR910M-DT US32D	630	-	-	1	1	322.90	-
		VR914M-DT US32D	630	-	-	1	1	322.90	-
VR910M-NL/VR914M-NL Vandal Resistant Trim Use w/Von Duprin 98/9975 Series Mortise Exit Devices	Stainless	VR910M-NL LHR US32D	630	-	-	1	1	322.90	-
		VR910M-NL RHR US32D	630	-	-	1	1	322.90	-
		VR914M-NL LHR US32D	630	-	-	1	1	322.90	-
		VR914M-NL RHR US32D	630	-	-	1	1	322.90	-
919 Flush Pull, Oval 4-23/32" High X 1-19/22" Wide x 15/32" Deep 	Brass	919-626	626	-	-	1	2	81.40	-
950 Flush Pull, Rectangular 3-3/4" High X 2-7/8" Wide x 11/16" Deep 	Brass	950-605	605	-	-	1	2	91.30	-
		950-613	613	-	-	1	2	95.40	-
		950-619	619	-	-	1	2	91.30	-
		950-625	625	-	-	1	2	91.30	-
		950-626**	626	-	-	1	2	73.00	-

HINGES
 CONTINUOUS HINGES
 PIVOTS
 Numerical 1-059
 Numerical 59-437
 Numerical 438-1021
 Numerical 1152-8190
 Numerical 8200-9266





Lead time exception: ** Products are stocked and will typically ship within 3 days

Bold pricing indicates item is in stock and available for **Fast Track** and **ProXpress**

	MODEL	SUBSTRATE	MODEL NUMBER	BHMA FINISH	WEIGHT	MUST BE ORDERED IN MULTIPLE QTY	MULTIPLE QTY	PACKED PER BOX	LIST PRICE		
									EACH	PACKAGE	
HINGES	955 Flush Pull, Rectangular 4-5/8" High X 3-29/32" Wide x 1-3/16" Deep 	Brass	955-613	613	-	-	1	2	\$154.30	-	
			955-626**	626	-	-	1	2	117.90	-	
CONTINUOUS HINGES	960 Flush Pull, Rectangular 3-1/16" High X 1-7/8" Wide x 9/16" Deep 	Brass	960-605	605	-	-	1	2	40.80	-	
			960-613	613	-	-	1	2	42.10	-	
			960-619	619	-	-	1	2	40.80	-	
			960-625	625	-	-	1	2	40.80	-	
			960-626**	626	-	-	1	2	32.20	-	
PIVOTS	962 Flush Pull, Rectangular Black Inset 3-15/16" High X 2-7/16" Wide x 19/32" Deep	Brass	962-613	613	-	-	1	2	86.80	-	
			962-626**	626	-	-	1	2	67.30	-	
Numerical 1-059	990 Sliding Door Pull Doors 1-1/8" to 1-1/2" 	Aluminum	990A3	666	-	-	1	10	8.80	-	
			990A5	-	-	-	1	10	8.80	-	
			990A14	669	-	-	1	10	8.80	-	
			990A15**	670	-	-	1	10	9.90	-	
			990A26D	702	-	-	1	10	8.80	-	
			990A-643E/716	-	-	-	1	10	8.80	-	
		Brass	990B3**	605	1.9	-	-	1	5	13.50	-
			990B-613**	613	1.9	-	-	1	5	15.60	-
			990B-619**	619	1.9	-	-	1	5	15.60	-
			990B26**	625	1.9	-	-	1	5	15.60	-
			990B26D	626	1.9	-	-	1	5	15.60	-
			990B-643E/716**	-	1.9	-	-	1	5	15.60	-
			990B-BLK**	622	1.9	-	-	1	5	15.60	-
			Numerical 59-437	991 Sliding Door Pull Privacy Doors 1-1/8" to 1-1/2" Thumb Turn on One Side Emergency Turn on Other Side 	Aluminum	991A3	666	-	-	1	10
991A5	-	-				-	1	10	10.40	-	
991A14	669	-				-	1	10	12.00	-	
991A15**	670	-				-	1	10	12.00	-	
991A26D**	702	-				-	1	10	12.00	-	
991A-643E/716**	-	-				-	1	10	12.00	-	
Brass	991B3**	605			2.3	-	-	1	5	19.00	-
	991B-613**	613			2.3	-	-	1	5	21.70	-
	991B-619**	619			2.3	-	-	1	5	21.70	-
	991B26**	625			2.3	-	-	1	5	21.70	-
	991B26D**	626			2.3	-	-	1	5	21.70	-
	991B-643E/716**	-			2.3	-	-	1	5	21.70	-
	991B-BLK**	622			2.3	-	-	1	5	21.70	-
	Numerical 438-1021	991 Sliding Door Pull Privacy Doors 1-1/8" to 1-1/2" Thumb Turn on One Side Emergency Turn on Other Side 			Aluminum	991A3	666	-	-	1	10
991A5			-	-		-	1	10	10.40	-	
991A14			669	-		-	1	10	12.00	-	
991A15**			670	-		-	1	10	12.00	-	
991A26D**			702	-		-	1	10	12.00	-	
991A-643E/716**			-	-		-	1	10	12.00	-	
Brass			991B3**	605	2.3	-	-	1	5	19.00	-
			991B-613**	613	2.3	-	-	1	5	21.70	-
			991B-619**	619	2.3	-	-	1	5	21.70	-
			991B26**	625	2.3	-	-	1	5	21.70	-
			991B26D**	626	2.3	-	-	1	5	21.70	-
			991B-643E/716**	-	2.3	-	-	1	5	21.70	-
			991B-BLK**	622	2.3	-	-	1	5	21.70	-
			Numerical 1152-8190	991 Sliding Door Pull Privacy Doors 1-1/8" to 1-1/2" Thumb Turn on One Side Emergency Turn on Other Side 	Aluminum	991A3	666	-	-	1	10
991A5	-	-				-	1	10	10.40	-	
991A14	669	-				-	1	10	12.00	-	
991A15**	670	-				-	1	10	12.00	-	
991A26D**	702	-				-	1	10	12.00	-	
991A-643E/716**	-	-				-	1	10	12.00	-	
Brass	991B3**	605			2.3	-	-	1	5	19.00	-
	991B-613**	613			2.3	-	-	1	5	21.70	-
	991B-619**	619			2.3	-	-	1	5	21.70	-
	991B26**	625			2.3	-	-	1	5	21.70	-
	991B26D**	626			2.3	-	-	1	5	21.70	-
	991B-643E/716**	-			2.3	-	-	1	5	21.70	-
	991B-BLK**	622			2.3	-	-	1	5	21.70	-
	Numerical 8200-9266	991 Sliding Door Pull Privacy Doors 1-1/8" to 1-1/2" Thumb Turn on One Side Emergency Turn on Other Side 			Aluminum	991A3	666	-	-	1	10
991A5			-	-		-	1	10	10.40	-	
991A14			669	-		-	1	10	12.00	-	
991A15**			670	-		-	1	10	12.00	-	
991A26D**			702	-		-	1	10	12.00	-	
991A-643E/716**			-	-		-	1	10	12.00	-	
Brass			991B3**	605	2.3	-	-	1	5	19.00	-
			991B-613**	613	2.3	-	-	1	5	21.70	-
			991B-619**	619	2.3	-	-	1	5	21.70	-
			991B26**	625	2.3	-	-	1	5	21.70	-
			991B26D**	626	2.3	-	-	1	5	21.70	-
			991B-643E/716**	-	2.3	-	-	1	5	21.70	-
			991B-BLK**	622	2.3	-	-	1	5	21.70	-

Lead time exception: ** Products are stocked and will typically ship within 3 days

Bold pricing indicates item is in stock and available for **Fast Track** and **ProXpress**

MODEL	SUBSTRATE	MODEL NUMBER	BHMA FINISH	WEIGHT	MUST BE ORDERED IN MULTIPLE QTY	MULTIPLE QTY	PACKED PER BOX	LIST PRICE	
								EACH	PACKAGE
RL1152 Combination Roller Latch/Applied Stop 	Brass	RL1152 US3	605	-	-	-	-	\$158.80	-
		RL1152 US4	606	-	-	-	-	150.50	-
		RL1152 US10	612	-	-	-	-	150.50	-
		RL1152 US10B	613	-	-	-	-	158.80	-
		RL1152 US15	619	-	-	-	-	158.80	-
		RL1152 US26	625	-	-	-	-	158.80	-
		RL1152 US26D**	626	-	-	-	-	155.50	-
		RL1152 643E/716	-	-	-	-	-	158.80	-
		RL1152 BLK**	622	-	-	-	-	158.80	-
FS1153/FS1154 Plunger Type Door Holder 	Aluminum	FS1153 US28**	628	-	-	-	-	55.70	-
	Brass	FS1154 US3	605	-	-	-	-	100.30	-
		FS1154 US4	606	-	-	-	-	100.30	-
		FS1154 US10	612	-	-	-	-	100.30	-
		FS1154 US10B	613	-	-	-	-	100.30	-
		FS1154 US26	625	-	-	-	-	100.30	-
FS1154 US26D**	626	-	-	-	-	100.30	-		
SB1600M1 Handle Up 1 1/2" Steel Bolt B-Packed w/Mortise Strikes T-Packed w/Universal Strikes L-Locking Version* UL Listed 	Steel	SB1600M1-B SP28	689	-	-	-	-	142.10	-
		SB1600M1-B SP10	691	-	-	-	-	150.20	-
		SB1600M1-B BLK	-	-	-	-	-	150.20	-
		SB1600M1-B SP313	695	-	-	-	-	142.10	-
		SB1600M1-B SP4	706	-	-	-	-	150.20	-
		SB1600M1-T SP10	691	-	-	-	-	150.20	-
		SB1600M1-T SP28	689	-	-	-	-	142.10	-
		SB1600M1-T SP313	695	-	-	-	-	142.10	-
		SB1600M1-T BLK	-	-	-	-	-	150.20	-
		SB1600M1-T SP4	706	-	-	-	-	150.20	-
		SB1600M1-BL SP10	691	-	-	-	-	199.60	-
		SB1600M1-BL SP28	689	-	-	-	-	206.90	-
		SB1600M1-BL SP313	695	-	-	-	-	206.90	-
		SB1600M1-BL BLK	-	-	-	-	-	207.70	-
		SB1600M1-BL SP4	706	-	-	-	-	199.60	-
		SB1600M1-TL SP10	691	-	-	-	-	207.70	-
		SB1600M1-TL SP28	689	-	-	-	-	207.70	-
		SB1600M1-TL SP313	695	-	-	-	-	199.60	-
SB1600M1-TL BLK	-	-	-	-	-	199.60	-		
SB1600M1-TL SP4	706	-	-	-	-	207.70	-		
SB1600M2 Handle Up 1 1/2" Steel Bolt B-Packed w/Mortise Strikes T-Packed w/Universal Strikes L-Locking Version* UL Listed 	Steel	SB1600M2-B SP4	706	-	-	-	-	150.20	-
		SB1600M2-B SP10	691	-	-	-	-	150.20	-
		SB1600M2-B SP28	689	-	-	-	-	142.10	-
		SB1600M2-B SP313	695	-	-	-	-	142.10	-
		SB1600M2-B BLK	-	-	-	-	-	150.20	-
		SB1600M2-BL SP4	706	-	-	-	-	207.70	-
		SB1600M2-T SP10	691	-	-	-	-	150.20	-
		SB1600M2-T SP28	689	-	-	-	-	142.10	-
		SB1600M2-T SP313	695	-	-	-	-	142.10	-
		SB1600M2-T BLK	-	-	-	-	-	150.20	-
		SB1600M2-T SP4	706	-	-	-	-	150.20	-
		SB1600M2-BL SP10	691	-	-	-	-	207.70	-
		SB1600M2-BL SP28	689	-	-	-	-	206.90	-
		SB1600M2-BL SP313	695	-	-	-	-	206.90	-
		SB1600M2-BL BLK	-	-	-	-	-	207.70	-
		SB1600M2-TL SP4	706	-	-	-	-	207.70	-
		SB1600M2-TL SP10	691	-	-	-	-	207.70	-
		SB1600M2-TL SP28	689	-	-	-	-	206.90	-
SB1600M2-TL SP313	695	-	-	-	-	206.90	-		
SB1600M2-TL BLK	-	-	-	-	-	207.70	-		

* Lock default code = 1289. Alternative Codes: 1360/1390/1395.

Lead time exception: ** Products are stocked and will typically ship within 3 days

Bold pricing indicates item is in stock and available for **Fast Track** and **ProXpress**



HINGES
 CONTINUOUS HINGES
 PIVOTS
 Numerical 1-059
 Numerical 59-437
 Numerical 438-1021
 Numerical 1152-8190
 Numerical 8200-9266

HINGES

CONTINUOUS
HINGES

PIVOTS



Numerical
1-059Numerical
59-437Numerical
438-1021Numerical
1152-8190Numerical
8200-9266

MODEL	SUBSTRATE	MODEL NUMBER	BHMA FINISH	WEIGHT	MUST BE ORDERED IN MULTIPLE QTY	MULTIPLE QTY	PACKED PER BOX	LIST PRICE	
								EACH	PACKAGE
SB1630 8" Steel Bolts B-Packed w/Mortise Strikes T-Packed w/Universal Strikes L-Locking Version* UL Listed 	Steel	SB1630-B US2G	603	-	-	-	-	47.90	-
		SB1630-B US10B	640	-	-	-	-	110.70	-
		SB1630-B US26D	652	-	-	-	-	68.40	-
		SB1630-T US2G	603	-	-	-	-	53.40	-
		SB1630-T US10B	640	-	-	-	-	116.00	-
		SB1630-T US26D	652	-	-	-	-	75.20	-
		SB1630-BL US2G	603	-	-	-	-	103.80	-
		SB1630-BL US10B	640	-	-	-	-	149.00	-
		SB1630-BL US26D	652	-	-	-	-	124.40	-
		SB1630-TL US2G	603	-	-	-	-	86.20	-
		SB1630-TL US10B	640	-	-	-	-	157.20	-
		SB1630-TL US26D	652	-	-	-	-	135.30	-
		SB1630-TB US2G	603	-	-	-	-	63.20	-
		SB1630-TB US10B	640	-	-	-	-	131.10	-
		SB1630-TB US26D	652	-	-	-	-	87.40	-
		SB1630-TBL US2G	603	-	-	-	-	99.70	-
SB1630-TBL US10B	640	-	-	-	-	169.20	-		
SB1630-TBL US26D	652	-	-	-	-	149.00	-		
SB1640 8" Steel Bolts B-Packed w/Mortise Strikes T-Packed w/Universal Strikes L-Locking Version* 	Brass	SB1640-B US3	605	-	-	-	-	135.30	-
		SB1640-B US10B	613	-	-	-	-	135.30	-
		SB1640-B US26D	626	-	-	-	-	121.70	-
		SB1640-T US3	605	-	-	-	-	142.10	-
		SB1640-T US10B	613	-	-	-	-	142.10	-
		SB1640-T US26D	626	-	-	-	-	131.10	-
		SB1640-BL US3	605	-	-	-	-	180.40	-
		SB1640-BL US10B	613	-	-	-	-	180.40	-
		SB1640-BL US26D	626	-	-	-	-	166.80	-
		SB1640-TL US3	605	-	-	-	-	189.90	-
SB1640-TL US10B	613	-	-	-	-	189.90	-		
SB1640-TL US26D	626	-	-	-	-	174.90	-		

* Lock default code = 1289. Alternative Codes: 1360/1390/1395.

Lead time exception: ** Products are stocked and will typically ship within 3 days

Bold pricing indicates item is in stock and available for **Fast Track** and **ProXpress**

MODEL	SUBSTRATE	MODEL NUMBER	VIEW NUMBER & FINISH	BHMA FINISH	MUST BE			LIST PRICE		
					ORDERED IN WEIGHT	MULTIPLE QTY	PACKED PER BOX	EACH	PACKAGE	
3125 Door Knocker 	Brass	02-3125-605	-	605	1	-	-	1	30.70	-
		02-3125-609	-	609	1	-	-	1	36.10	-
		02-3125-619	-	619	1	-	-	1	36.10	-
		02-3125-625	-	625	1	-	-	1	36.10	-
		02-3125-626	-	626	1	-	-	1	30.70	-
		02-3125-643E/716	-	-	1	-	-	1	36.10	-
		02-3125-BLK	-	622	1	-	-	1	36.10	-
31251/31252 Knocker/Viewer Available w/UL Viewer Only 	Brass	02-31251U-605	U700 w 606 viewer	605	-	-	-	1	44.50	-
		02-31251U-619	U700 w 619 viewer	619	-	-	-	1	50.80	-
		02-31251U-625	U700 w 625 viewer	625	-	-	-	1	50.80	-
		02-31251U-626	U700 w 626 viewer	626	-	-	-	1	50.80	-
		02-31251U-643E/716	U700 w 10B viewer	-	-	-	-	1	42.20	-
		02-31251U-BLK	U700 w BLK viewer	622	-	-	-	1	50.80	-
		02-31252U-605	U701 w 606 viewer	605	-	-	-	1	46.40	-
		02-31252U-619	U701 w 619 viewer	619	-	-	-	1	52.90	-
		02-31252U-625	U701 w 625 viewer	625	-	-	-	1	52.90	-
		02-31252U-626	U701 w 626 viewer	626	-	-	-	1	52.90	-
		02-31252U-643E/716	U701 w 10B viewer	-	-	-	-	1	44.20	-
		02-31252U-BLK	U701 w BLK viewer	622	-	-	-	1	52.90	-

HINGES
 CONTINUOUS HINGES
 PIVOTS
 Numerical 1-059
 Numerical 59-437
 Numerical 438-1021
 Numerical 1152-8190
 Numerical 8200-9266

Lead time exception: ** Products are stocked and will typically ship within 3 days Bold pricing indicates item is in stock and available for **Fast Track** and **ProXpress**

8100/8300/9100/9200 Series Pulls

8169/8181/8281/8189/8312/8320/8371/8372/8373/8700/8800/8848/8975 - Decorative Series

Mounting Methods

HINGES
 CONTINUOUS HINGES
 PIVOTS
 Numerical 1-059
 Numerical 59-437
 Numerical 438-1021
 Numerical 1152-8190
 Numerical 8200-9266

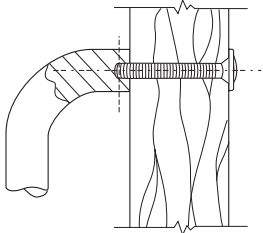
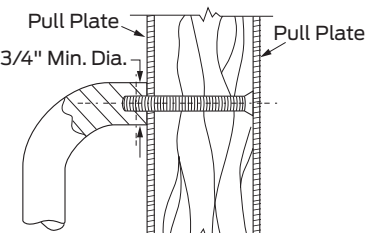
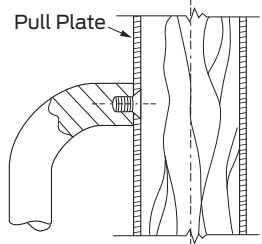
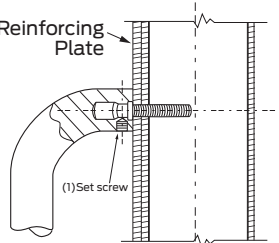
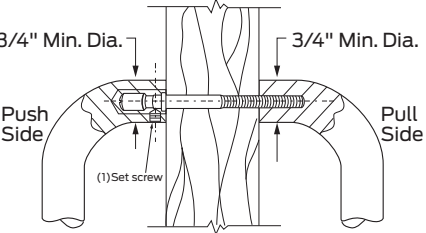
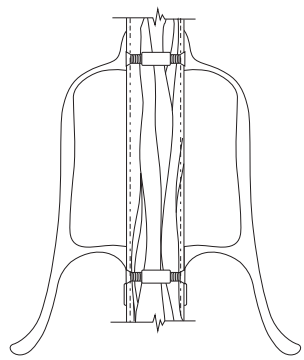
<p>Type Standard Mount</p>  <p>Standard Mounting</p>	<p>Type F Mount</p>  <p>Wood Doors Concealed Pull Mounting With Push Plate</p>	<p>Type G Mount</p>  <p>Concealed Pull Plate Mounting</p>
<p>Type L Mount</p>  <p>Reinforced Hollow Metal Door Concealed Pull Mounting</p>	<p>Type J or N Mount</p>  <p>Back to Back "Two-Anchor" Wood or Metal Door</p>	 <p>Back to Back Pull Mounting</p>

Lead time exception: ** Products are stocked and will typically ship within 3 days

Bold pricing indicates item is in stock and available for **Fast Track** and **ProXpress**

8100/8300/9100/9200 Series Pulls

8169/8181/8281/8189/8312/8320/8371/8372/8373/8700/8800/8848/8975 - Decorative Series

Mounting Methods

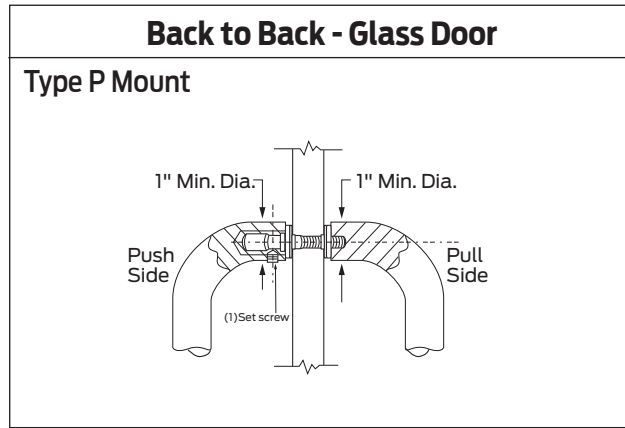
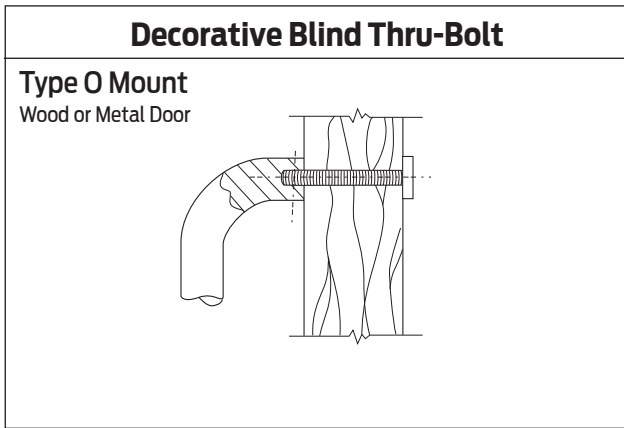

HINGES
CONTINUOUS HINGES
PIVOTS
Numerical 1-059
Numerical 59-437
Numerical 438-1021
Numerical 1152-8190
Numerical 8200-9266

Lead time exception: ** Products are stocked and will typically ship within 3 days

*Bold pricing indicates item is in stock and available for **Fast Track** and **ProXpress***

8100/8200/8300/9100/9200 - Series

8169/8181/8281/8189/8312/8320/8371/8372/8373/8700/8800/8848/8975 - Decorative Series

Special Pricing Information

- Through bolt fasteners are for standard 1-3/4" thick doors.
- Specify door thickness if other than standard. \$25 List Add for door thicknesses greater than 2 1/4".
- All screws are furnished standard as Phillips Head Drive.
- For fasteners other than shown contact our Customer Service Department for availability.

	Suffix		List Add	
Optional Mounting Types:	No Suffix Req'd	Standard (Provided with all single pulls unless other mount noted.)	8102HD, 8103HD, 8103EZHD, 8105, 8111-5, 8145EZHD, 8190HD, 8190EZHD, 8302, 8303, 8305, 8311, 9100HD, 9264, 9266 8169, 8181, 8281, 8189, 8312, 8320, 8371, 8372, 8373, 8700, 8800, 8848, 8975	No Additional Charge
	A	Concealed (One side, Aluminum)	8103HD, 8103EZHD, 8145EZHD, 8190HD, 8190EZHD, 8303, 9100HD, 9264, 9266 8169, 8181, 8281, 8189, 8312, 8320, 8371, 8848, 8975	20.00
	F	Countersunk Thru Bolt	8102HD, 8103HD, 8103EZHD, 8105, 8111-5, 8145EZHD, 8190HD, 8190EZHD, 8302, 8303, 8305, 8311, 9100HD 8169, 8181, 8281, 8189, 8312, 8320, 8371, 8372, 8373, 8700, 8800, 8848, 8975	No Additional Charge
	G	Concealed Pull Plate	8102, 8103, 8111, 8300, 8302, 8303, 8311	No Additional Charge
	I	Concealed (One Side, Wood Door)	8102HD, 8103HD, 8103EZHD, 8145EZHD, 8190HD, 8190EZHD, 8302, 8303, 9100HD, 9264, 9266 8169, 8181, 8281, 8189, 8312, 8320, 8371, 8372, 8373, 8700, 8800, 8848, 8975	14.00
	J*	Back to Back (Wood/Hollow Metal - 3/4" Round and Flat)	8102HD, 8302 8372, 8373, 8700, 8800	28.00
	K*	Back to Back (8121)	8121	9.00
	L	Concealed (One Side, Hollow Metal)	8103HD, 8103EZHD, 8145EZHD, 8190HD, 8190EZHD, 8303, 9100HD, 9264, 9266 8169, 8181, 8281, 8189, 8312, 8320, 8371, 8372, 8373, 8700, 8800, 8848, 8975	20.00
	N*	Back to Back (Wood/Hollow Metal - 1" Round)	8103HD, 8103EZHD, 8145EZHD, 8190HD, 8190EZHD, 8303, 9100HD, 9264, 9266 8169, 8181, 8281, 8189, 8312, 8320, 8371, 8848, 8975	28.00
	NO	Push Bar and Pull - Back to Back & Decorative Blind Thru Bolt (Wood/Hollow Metal)	9100HD, 9103EZHD, 9145EZHD, 9190HD, 9190EZHD	42.00
	NS	Push Bar and Pull - Back to Back & Standard (Wood/Hollow Metal)	9100HD, 9103EZHD, 9145EZHD, 9190HD, 9190EZHD	No Additional Charge
	O	Decorative Blind Thru Bolt (Wood/Hollow Metal)	8103HD, 8103EZHD, 8145EZHD, 8190HD, 8190EZHD, 9100HD, 9264, 9266 8169, 8181, 8281, 8189, 8312, 8320, 8371, 8848, 8975	32.00
	P*	Back to Back (1/2" Glass)	8103HD, 8103EZHD, 8145EZHD, 8190HD, 8190EZHD, 9100HD, 9264, 9266 8169, 8181, 8281, 8189, 8312, 8320, 8371, 8848, 8975	33.00
	PQ	Push Bar and Pull - Back to Back and Decorative Blind Thru Bolt (1/2" Glass)	9100HD, 9103EZHD, 9145EZHD, 9190HD, 9190EZHD	70.00
	Q	Decorative Blind Thru Bolt (1/2" Glass)	8103HD, 8103EZHD, 8145EZHD, 8190HD, 8190EZHD, 9100HD, 9264, 9266 8169, 8181, 8281, 8189, 8312, 8320, 8371, 8848, 8975	45.00
	X	Security Thru Bolt with Std. Washer.	8103HD, 8103EZHD, 8145EZHD, 8190HD, 8190EZHD, 8303, 9100HD, 9264, 9266 8169, 8181, 8281, 8189, 8312, 8320, 8371, 8848, 8975	54.00 - 613/US10B 34.00 all other Finishes
		Prefix		
	* PR	Order as pair with model numbers (e.g. - PR8103EZ)	Double the list price for single unit and add mounting price from above.	
	SGL	Single pull model machined for back to back application.	Based on mounting	
	Model			
Optional Custom Lengths: (available in 1" increments, fractional increments available as engineered specials)	9100HD, 9103EZHD, 9145EZHD, 9190HD, 9190EZHD	For lengths <28"	Same as 28" List Price	
		For lengths >28" and <33"	Same as 33" List Price	
		For lengths >33"	9.00/additional inch	
		Fractional increments available as engineered specials. List Add in addition to custom length pricing	181.00 List Add	
Optional Finish	AM	Anti-microbial Coating - US26D or US32D finishes only	40.00	
Optional Cut-Outs:	CFC	Cut for cylinder on 8200/8300 Series Push or Pull Plates (1-1/4" diameter)	7.00	
	CFT	Cut for Thumbturn on 8200/8300 Series Push or Pull Plates (3/8" diameter)	8.00	
Plates ordered for cut-out for cylinder or thumbturn, cutout is positioned 2" from top and centered in the plate width, up to 4" wide plates. For plates over 4" in width, cut-out is located 2" from edge. Please specify Door Handing LH or RH when ordering plates wider than 4".				
	Model	Description	List Add	
Optional Plate:	8300	For plate pierced for Pull, order 8300 Series Specify Center to Center dimension (5-1/4", 6", 8", 10"), Finish, and Plate Size	(to 8200 list price) 2.50	

Lead time exception: ** Products are stocked and will typically ship within 3 days

Bold pricing indicates item is in stock and available for **Fast Track** and **ProXpress**

MODEL	PULL CTC	SUBSTRATE	MODEL NUMBER	BHMA FINISH	WEIGHT	MUST BE ORDERED IN MULTIPLE QTY	MULTIPLE QTY	PACKED PER BOX	LIST PRICE		
									EACH	PACKAGE	
8102HD Straight Door Pull 3/4" Round, 1-1/2" Clearance Antimicrobial Coating US26D-AM or US32D-AM available. See page 68 for optional mounting types and pricing.	6"	Brass	8102HD-6 US3	605	-	-	1	-	\$53.90	-	
			8102HD-6 US4	606	-	-	1	-	53.90	-	
			8102HD-6 US10	612	-	-	1	-	61.50	-	
			8102HD-6 US10B	613	-	-	1	-	63.60	-	
			8102HD-6 US26	625	-	-	1	-	60.60	-	
			8102HD-6 US26D	626	-	-	1	-	53.90	-	
		Aluminum	8102HD-6 US28	628	-	-	1	-	21.50	-	
			Stainless	8102HD-6 US15	619	-	-	1	-	63.60	-
				8102HD-6 US32D	630	-	-	1	-	32.60	-
		8"	Brass	8102HD-8 US3	605	-	-	1	-	60.60	-
				8102HD-8 US4	606	-	-	1	-	60.60	-
				8102HD-8 US10	612	-	-	1	-	69.50	-
	8102HD-8 US10B			613	-	-	1	-	71.90	-	
	8102HD-8 US26			625	-	-	1	-	67.40	-	
	8102HD-8 US26D			626	-	-	1	-	60.60	-	
	Aluminum	8102HD-8 US28	628	-	-	1	-	22.40	-		
		Stainless	8102HD-8 US15	619	-	-	1	-	71.90	-	
			8102HD-8 US32D	630	-	-	1	-	36.70	-	
			8102HD-8 643E/716	-	-	-	1	-	71.90	-	
			8102HD-8 BLK	-	-	-	1	-	60.60	-	
		10"	Brass	8102HD-0 US3	605	-	-	1	-	70.80	-
	8102HD-0 US4			606	-	-	1	-	70.80	-	
	8102HD-0 US10			612	-	-	1	-	81.60	-	
	8102HD-0 US10B			613	-	-	1	-	83.70	-	
	8102HD-0 US26			625	-	-	1	-	69.10	-	
	8102HD-0 US26D			626	-	-	1	-	69.50	-	
	Aluminum		8102HD-0 US28	628	-	-	1	-	23.90	-	
			Stainless	8102HD-0 US15	619	-	-	1	-	83.70	-
8102HD-0 US32D	630			-	-	1	-	43.10	-		
8102HD-0 643E/716	-			-	-	1	-	83.70	-		
8102HD-0 BLK	-			-	-	1	-	70.80	-		
8103HD Straight Door Pull 1" Round, 1-1/2" Clearance Antimicrobial Coating US26D-AM or US32D-AM available. See page 64 for optional mounting types and pricing.	8"		Brass	8103HD-8 US3	605	-	-	1	-	107.60	-
		8103HD-8 US4		606	-	-	1	-	107.60	-	
		8103HD-8 US10		612	-	-	1	-	121.20	-	
		8103HD-8 US10B		613	-	-	1	-	125.50	-	
		8103HD-8 US26		625	-	-	1	-	114.60	-	
		8103HD-8 US26D		626	-	-	1	-	108.10	-	
		Aluminum	8103HD-8 US28	628	-	-	1	-	31.20	-	
			Stainless	8103HD-8 US15	619	-	-	1	-	125.50	-
				8103HD-8 US32	629	-	-	1	-	77.50	-
		8103HD-8 US32D		630	-	-	1	-	64.00	-	
		8103HD-8 643E/716		-	-	-	1	-	125.50	-	
		8103HD-8 BLK	-	-	-	1	-	107.60	-		
	10"	Brass	8103HD-0 US3	605	-	-	1	-	118.90	-	
			8103HD-0 US4	606	-	-	1	-	118.90	-	
			8103HD-0 US10	612	-	-	1	-	136.80	-	
			8103HD-0 US10B	613	-	-	1	-	136.80	-	
			8103HD-0 US26	625	-	-	1	-	125.50	-	
			8103HD-0 US26D	626	-	-	1	-	118.90	-	
		Aluminum	8103HD-0 US28	628	-	-	1	-	32.80	-	
			Stainless	8103HD-0 US15	619	-	-	1	-	141.40	-
		8103HD-0 US32		629	-	-	1	-	86.00	-	
		8103HD-0 US32D		630	-	-	1	-	71.80	-	
		8103HD-0 643E/716		-	-	-	1	-	136.80	-	
		8103HD-0 BLK	-	-	-	1	-	118.90	-		



Continued on next page.

Lead time exception: ** Products are stocked and will typically ship within 3 days

Bold pricing indicates item is in stock and available for **Fast Track** and **ProXpress**

HINGES
 CONTINUOUS HINGES
 PIVOTS
 Numerical 1-059
 Numerical 59-437
 Numerical 438-1021
 Numerical 1152-8190
 Numerical 8200-9266

HINGES
 CONTINUOUS HINGES
 PIVOTS
 Numerical 1-059
 Numerical 59-437
 Numerical 438-1021
 Numerical 1152-8190
 Numerical 8200-9266

MODEL	PULL CTC	SUBSTRATE	MODEL NUMBER	BHMA FINISH	WEIGHT	MUST BE ORDERED IN MULTIPLE QTY	MULTIPLE QTY	PACKED PER BOX	LIST PRICE			
									EACH	PACKAGE		
8103HD Straight Door Pull 1" Round, 1-1/2" Clearance  <i>Continued from previous page.</i>	12"	Brass	8103HD-2 US3	605	-	-	1	-	\$129.90	-		
			8103HD-2 US4	606	-	-	1	-	129.90	-		
			8103HD-2 US10	612	-	-	1	-	152.40	-		
			8103HD-2 US10B	613	-	-	1	-	154.90	-		
			8103HD-2 US26	625	-	-	1	-	138.10	-		
			8103HD-2 US26D	626	-	-	1	-	132.40	-		
		Aluminum	8103HD-2 US28	628	-	-	1	-	34.50	-		
		Stainless	8103HD-2 US15	619	-	-	1	-	154.90	-		
			8103HD-2 US32	629	-	-	1	-	94.30	-		
			8103HD-2 US32D	630	-	-	1	-	82.60	-		
			8103HD-2 643E/716	-	-	-	1	-	154.90	-		
8103HD-2 BLK	-		-	-	1	-	129.90	-				
8103EZHD Straight Door Pull 1" Round, 2-1/2" Clearance Antimicrobial Coating US26D-AM or US32D-AM available. See page 68 for optional mounting types and pricing. 	8"	Brass	8103EZHD-8 US3	605	-	-	1	-	117.20	-		
			8103EZHD-8 US4	606	-	-	1	-	117.20	-		
			8103EZHD-8 US10	612	-	-	1	-	130.40	-		
			8103EZHD-8 US10B	613	-	-	1	-	134.70	-		
			8103EZHD-8 US26	625	-	-	1	-	123.60	-		
			8103EZHD-8 US26D	626	-	-	1	-	117.40	-		
		Aluminum	8103EZHD-8 US28	628	-	-	1	-	41.90	-		
		316 Stainless	8103EZHD-8 US15	619	-	-	1	-	134.70	-		
			8103EZHD-8 US32	629-316	-	-	1	-	102.80	-		
			8103EZHD-8 US32D	630-316	-	-	1	-	89.50	-		
			8103EZHD-8 643E/716	-	-	-	1	-	134.70	-		
			8103EZHD-8 BLK	-	-	-	1	-	117.20	-		
			10"	Brass	8103EZHD-0 US3	605	-	-	1	-	128.10	-
					8103EZHD-0 US4	606	-	-	1	-	128.10	-
	8103EZHD-0 US10	612			-	-	1	-	146.00	-		
	8103EZHD-0 US10B	613		-	-	1	-	150.50	-			
	8103EZHD-0 US26	625		-	-	1	-	134.70	-			
	8103EZHD-0 US26D	626		-	-	1	-	128.10	-			
	Aluminum	8103EZHD-0 US28	628	-	-	1	-	43.80	-			
	316 Stainless	8103EZHD-0 US15	619	-	-	1	-	150.50	-			
		8103EZHD-0 32-316	629-316	-	-	1	-	112.70	-			
		8103EZHD-0 32D-316**	630-316	-	-	1	-	99.20	-			
		8103EZHD-0 643E/716	-	-	-	1	-	150.50	-			
		8103EZHD-0 BLK	-	-	-	1	-	128.10	-			
	12"	Brass	8103EZHD-2 US3	605	-	-	1	-	139.20	-		
			8103EZHD-2 US4	606	-	-	1	-	139.20	-		
			8103EZHD-2 US10	612	-	-	1	-	161.70	-		
8103EZHD-2 US10B			613	-	-	1	-	164.00	-			
8103EZHD-2 US26			625	-	-	1	-	147.40	-			
8103EZHD-2 US26D			626	-	-	1	-	141.80	-			
Aluminum		8103EZHD-2 US28	628	-	-	1	-	45.70	-			
316 Stainless		8103EZHD-2 US15	619	-	-	1	-	164.00	-			
		8103EZHD-2 32-316	629-316	-	-	1	-	122.50	-			
		8103EZHD-2 32D-316	630-316	-	-	1	-	108.60	-			
		8103EZHD-2 643E/716	-	-	-	1	-	164.00	-			
		8103EZHD-2 BLK	-	-	-	1	-	139.20	-			

Lead time exception: ** Products are stocked and will typically ship within 3 days

Bold pricing indicates item is in stock and available for **Fast Track** and **ProXpress**

MODEL	PULL CTC	SUBSTRATE	MODEL NUMBER	BHMA FINISH	WEIGHT	MUST BE ORDERED IN MULTIPLE QTY	MULTIPLE QTY	PACKED PER BOX	LIST PRICE	
									EACH	PACKAGE
8105 Straight Door Pull 1" Flattened 1/2 Round, 1-1/2" Clearance Antimicrobial Coating US26D-AM or US32D-AM available. See page 68 for optional mounting types and pricing.	6"	Brass	8105-6 US3	605	-	-	1	-	\$58.70	-
			8105-6 US4	606	-	-	1	-	58.70	-
			8105-6 US10	612	-	-	1	-	72.10	-
			8105-6 US10B	613	-	-	1	-	74.00	-
			8105-6 US26	625	-	-	1	-	74.00	-
			8105-6 US26D	626	-	-	1	-	59.20	-
		Aluminum	8105-6 US28	628	-	-	1	-	54.00	-
		Stainless	8105-6 US15	619	-	-	1	-	24.50	-
			8105-6 US32D	630	-	-	1	-	44.80	-
	8105-6 643E/716		-	-	-	1	-	74.00	-	
	8105-6 BLK	-	-	-	1	-	58.70	-		
	8"	Brass	8105-8 US3	605	-	-	1	-	91.30	-
			8105-8 US4	606	-	-	1	-	91.30	-
			8105-8 US10	612	-	-	1	-	99.20	-
			8105-8 US10B	613	-	-	1	-	99.20	-
			8105-8 US26	625	-	-	1	-	99.20	-
			8105-8 US26D	626	-	-	1	-	95.20	-
		Aluminum	8105-8 US28	628	-	-	1	-	95.20	-
		Stainless	8105-8 US15	619	-	-	1	-	30.70	-
			8105-8 US32D	630	-	-	1	-	65.30	-
	8105-8 643E/716		-	-	-	1	-	99.20	-	
8105-8 BLK	-	-	-	1	-	91.30	-			
10"	Brass	8105-0 US3	605	-	-	1	-	99.20	-	
		8105-0 US4	606	-	-	1	-	99.20	-	
		8105-0 US10	612	-	-	1	-	111.00	-	
		8105-0 US10B	613	-	-	1	-	111.00	-	
		8105-0 US26	625	-	-	1	-	111.00	-	
		8105-0 US26D	626	-	-	1	-	103.20	-	
	Aluminum	8105-0 US28	628	-	-	1	-	103.20	-	
	Stainless	8105-0 US15	619	-	-	1	-	31.60	-	
		8105-0 US32D	630	-	-	1	-	73.50	-	
8105-0 643E/716		-	-	-	1	-	111.00	-		
8105-0 BLK	-	-	-	1	-	99.20	-			
8111 Door Pull 1-3/16" Projection Antimicrobial Coating US26D-AM or US32D-AM available. See page 68 for optional mounting types and pricing.	5" (Actual CTC = 5-1/4")	Brass	8111-5 US3	605	-	-	1	-	55.60	-
			8111-5 US4	606	-	-	1	-	55.60	-
			8111-5 US10	612	-	-	1	-	62.10	-
			8111-5 US10B	613	-	-	1	-	62.10	-
			8111-5 US26	625	-	-	1	-	62.10	-
			8111-5 US26D	626	-	-	1	-	55.60	-
		Aluminum	8111-5 US28	628	-	-	1	-	59.50	-
		Stainless	8111-5 US15	619	-	-	1	-	34.60	-
			8111-5 US32D	630	-	-	1	-	51.40	-
			8111-5 643E/716	613	-	-	1	-	62.10	-
			8111-5 BLK	605	-	-	1	-	55.60	-
8112 Door Pull 2-3/16" Surface Mounted Antimicrobial Coating US26D-AM available.	5"	Brass	8112-5 US26D	626	-	-	1	-	43.50	-

HINGES
 CONTINUOUS HINGES
 PIVOTS
 Numerical 1-059
 Numerical 59-437
 Numerical 438-1021
 Numerical 1152-8190
 Numerical 8200-9266

Lead time exception: ** Products are stocked and will typically ship within 3 days

Bold pricing indicates item is in stock and available for **Fast Track** and **ProXpress**

HINGES

CONTINUOUS HINGES

PIVOTS



Numerical 1-059

Numerical 59-437

Numerical 438-1021

Numerical 1152-8190



Numerical 8200-9266

MODEL	PULL CTC	SUBSTRATE	MODEL NUMBER	BHMA FINISH	WEIGHT	MUST BE ORDERED IN MULTIPLE QTY	MULTIPLE QTY	PACKED PER BOX	LIST PRICE		
									EACH	PACKAGE	
8121 Door Pull 3-1/2" Antimicrobial Coating US26D-AM available. Surface Mounted 	5"	Brass	8121-5 US26D	626	-	-	1	-	\$63.30	-	
			See page 68 for optional mounting types and pricing.								
8145EZHD 45 Offset Door Pull 1" Round, 2-1/2" Clearance Antimicrobial Coating US26D-AM or US32D-AM available. See page 68 for optional mounting types and pricing.	8"	Brass	8145EZHD-8 US3	605	-	-	1	-	134.00	-	
			8145EZHD-8 US4	606	-	-	1	-	134.00	-	
			8145EZHD-8 US10	612	-	-	1	-	154.50	-	
			8145EZHD-8 US10B	613	-	-	1	-	154.50	-	
			8145EZHD-8 US26	625	-	-	1	-	142.00	-	
			8145EZHD-8 US26D	626	-	-	1	-	142.00	-	
			316 Stainless	8145EZHD-8 US15	619	-	-	1	-	154.50	-
				8145EZHD-8 32-316	629-316	-	-	1	-	140.80	-
	8145EZHD-8 32D-316	630-316		-	-	1	-	116.20	-		
	8145EZHD-8 643E/716	-		-	-	1	-	154.50	-		
	10"	Brass	8145EZHD-0 US3	605	-	-	1	-	146.10	-	
			8145EZHD-0 US4	606	-	-	1	-	146.10	-	
			8145EZHD-0 US10	612	-	-	1	-	163.30	-	
			8145EZHD-0 US10B	613	-	-	1	-	163.30	-	
			8145EZHD-0 US26	625	-	-	1	-	154.50	-	
			8145EZHD-0 US26D	626	-	-	1	-	154.50	-	
			316 Stainless	8145EZHD-0 US15	619	-	-	1	-	163.30	-
				8145EZHD-0 32-316	629-316	-	-	1	-	150.70	-
	8145EZHD-0 32D-316	630-316		-	-	1	-	126.00	-		
	8145EZHD-0 643E/716	-		-	-	1	-	163.30	-		
	12"	Brass	8145EZHD-2 US3	605	-	-	1	-	154.50	-	
			8145EZHD-2 US4	606	-	-	1	-	154.50	-	
			8145EZHD-2 US10	612	-	-	1	-	175.70	-	
			8145EZHD-2 US10B	613	-	-	1	-	175.70	-	
			8145EZHD-2 US26	625	-	-	1	-	167.50	-	
			8145EZHD-2 US26D	626	-	-	1	-	167.50	-	
			316 Stainless	8145EZHD-2 US15	619	-	-	1	-	175.70	-
				8145EZHD-2 32-316	629-316	-	-	1	-	160.70	-
8145EZHD-2 32D-316	630-316	-		-	1	-	136.00	-			
8145EZHD-2 643E/716	-	-		-	1	-	175.70	-			
18"	Brass	8145EZHD-18 US3	605	-	-	1	-	209.20	-		
		8145EZHD-18 US4	606	-	-	1	-	209.20	-		
		8145EZHD-18 US10	612	-	-	1	-	234.30	-		
		8145EZHD-18 US10B	613	-	-	1	-	234.30	-		
		8145EZHD-18 US26	625	-	-	1	-	221.50	-		
		8145EZHD-18 US26D	626	-	-	1	-	221.50	-		
		316 Stainless	8145EZHD-18 US15	619	-	-	1	-	234.30	-	
			8145EZHD-18 32-316	629-316	-	-	1	-	217.40	-	
8145EZHD-18 32D-316	630-316		-	-	1	-	192.90	-			
8145EZHD-18 643E/716	-		-	-	1	-	234.30	-			
8169 Tubular Decorative C Shaped Pull 1" Dia. See page 68 for optional mounting types and pricing. 	10"	Brass	8169-10-605	605	-	-	1	-	319.90	-	
			8169-10-613	613	-	-	1	-	319.90	-	
			8169-10-619*	619	-	-	1	-	319.90	-	
			8169-10-625*	625	-	-	1	-	319.90	-	
			8169-10-626*	626	-	-	1	-	319.90	-	
			Stainless	8169-10-630	630	-	-	1	-	284.40	-
				8169-10-BLK	-	-	-	1	-	319.90	-
	12"	Brass	8169-12-605	605	-	-	1	-	419.40	-	
			8169-12-613*	613	-	-	1	-	419.40	-	
			8169-12-619*	619	-	-	1	-	419.40	-	
			8169-12-625*	625	-	-	1	-	419.40	-	
			8169-12-626*	626	-	-	1	-	419.40	-	
			Stainless	8169-12-630	630	-	-	1	-	294.20	-
				8169-12-BLK*	-	-	-	1	-	419.40	-

Lead time exception: ** Products are stocked and will typically ship in 3-5 days

*Finishes marked may date up to 4-5 weeks for shipment.

Bold pricing indicates item is in stock and available for **Fast Track** and **ProXpress**

MODEL	PULL CTC	SUBSTRATE	MODEL NUMBER	BHMA FINISH	WEIGHT	MUST BE ORDERED IN MULTIPLE QTY	MULTIPLE QTY	PACKED PER BOX	LIST PRICE		
									EACH	PACKAGE	
8181 Georgian Decorative Offset Pull 3/4" Dia. See page 68 for optional mounting types and pricing. 	12"	Brass	8181-12-605	605	-	-	1	-	\$508.60	-	
			8181-12-613	613	-	-	1	-	508.60	-	
			8181-12-619*	619	-	-	1	-	508.60	-	
			8181-12-625*	625	-	-	1	-	508.60	-	
			8181-12-626*	626	-	-	1	-	508.60	-	
		Aluminum	8181-12-628*	628	-	-	1	-	478.20	-	
	16"	Brass	8181-12-630	630	-	-	1	-	490.30	-	
			8181-12-BLK*	-	-	-	1	-	508.60	-	
			8181-16-605	605	-	-	1	-	570.50	-	
			8181-16-613	613	-	-	1	-	570.50	-	
			8181-16-619*	619	-	-	1	-	570.50	-	
		8181-16-625*	625	-	-	1	-	570.50	-		
	18"	Brass	8181-16-626*	626	-	-	1	-	570.50	-	
			Aluminum	8181-16-628*	628	-	-	1	-	571.30	-
			Stainless	8181-16-630	630	-	-	1	-	570.50	-
			8181-16-BLK*	-	-	-	1	-	570.50	-	
			8181-18-605	605	-	-	1	-	601.50	-	
		8181-18-613	613	-	-	1	-	601.50	-		
	19 13/16"	Brass	8181-18-619*	619	-	-	1	-	601.50	-	
			8181-18-625*	625	-	-	1	-	601.50	-	
			8181-18-626*	626	-	-	1	-	601.50	-	
			Aluminum	8181-18-628*	628	-	-	1	-	602.30	-
			Stainless	8181-18-630	630	-	-	1	-	601.50	-
		8181-18-BLK*	-	-	-	1	-	601.50	-		
8189 Athens Decorative Offset Long Pull - 1 1/4" Dia. See page 68 for optional mounting types and pricing. Custom lengths available as engineered special 	19 13/16"	Brass	8189-19-605*	605	-	-	1	-	1,287.00	-	
			8189-19-613*	613	-	-	1	-	1,338.40	-	
			8189-19-619*	619	-	-	1	-	1,421.90	-	
			8189-19-625*	625	-	-	1	-	1,421.90	-	
			8189-19-626*	626	-	-	1	-	1,421.90	-	
		Stainless	8189-19-630*	630	-	-	1	-	807.80	-	
	8189-19-BLK*	-	-	-	1	-	1,421.90	-			
	8190HD 90° Offset Door Pull 1" Round, 2-1/4" Clearance Antimicrobial Coating US26D-AM or US32D-AM available. See page 68 for optional mounting types and pricing. 	8"	Brass	8190HD-8 US3	605	-	-	1	-	126.90	-
				8190HD-8 US4	606	-	-	1	-	126.90	-
				8190HD-8 US10	612	-	-	1	-	146.60	-
				8190HD-8 US10B	613	-	-	1	-	146.60	-
				8190HD-8 US26	625	-	-	1	-	134.60	-
8190HD-8 US26D				626	-	-	1	-	134.60	-	
Stainless			8190HD-8 US15	619	-	-	1	-	146.60	-	
			8190HD-8 US32	629	-	-	1	-	112.90	-	
			8190HD-8 US32D	630	-	-	1	-	93.20	-	
			8190HD-8 643E/716	-	-	-	1	-	146.60	-	
			8190HD-8 BLK	-	-	-	1	-	126.90	-	
			10"	Brass	8190HD-0 US3	605	-	-	1	-	138.60
8190HD-0 US4		606			-	-	1	-	138.60	-	
8190HD-0 US10		612			-	-	1	-	154.50	-	
8190HD-0 US10B		613			-	-	1	-	148.50	-	
8190HD-0 US26		625			-	-	1	-	146.60	-	
8190HD-0 US26D		626			-	-	1	-	140.50	-	
Stainless		8190HD-0 US15		619	-	-	1	-	154.50	-	
		8190HD-0 US32		629	-	-	1	-	120.80	-	
		8190HD-0 US32D**		630	-	-	1	-	96.90	-	
		8190HD-0 643E/716		-	-	-	1	-	148.50	-	
		8190HD-0 BLK		-	-	-	1	-	138.60	-	
		12"		Brass	8190HD-2 US3	605	-	-	1	-	146.60
8190HD-2 US4			606		-	-	1	-	146.60	-	
8190HD-2 US10			612		-	-	1	-	166.50	-	
8190HD-2 US10B			613		-	-	1	-	166.50	-	
8190HD-2 US26			625		-	-	1	-	158.70	-	
8190HD-2 US26D			626		-	-	1	-	158.70	-	
Stainless			8190HD-2 US15	619	-	-	1	-	166.50	-	
			8190HD-2 US32	629	-	-	1	-	129.00	-	
			8190HD-2 US32D**	630	-	-	1	-	104.50	-	
			8190HD-2 643E/716	-	-	-	1	-	166.50	-	
			8190HD-2 BLK	-	-	-	1	-	146.60	-	
			18"	Brass	8190HD-18 US3	605	-	-	1	-	198.20
8190HD-18 US4		606			-	-	1	-	198.20	-	
8190HD-18 US10		612			-	-	1	-	222.00	-	
8190HD-18 US10B	613	-			-	1	-	222.00	-		
8190HD-18 US26	625	-			-	1	-	210.00	-		
8190HD-18 US26D	626	-			-	1	-	210.00	-		
Stainless	8190HD-18 US15	619		-	-	1	-	222.00	-		
	8190HD-18 US32	629		-	-	1	-	174.20	-		
	8190HD-18 US32D	630		-	-	1	-	148.50	-		
	8190HD-18 643E/716	-		-	-	1	-	222.00	-		
	8190HD-18 BLK	-		-	-	1	-	198.20	-		

HINGES

CONTINUOUS HINGES

PIVOTS

Numerical 1-059

Numerical 59-437

Numerical 438-1021

Numerical 1152-8190

Numerical 8200-9266

Lead time exception: ** Products are stocked and will typically ship in 3-5 days

*Finishes marked may date up to 4-5 weeks for shipment.

Bold pricing indicates item is in stock and available for **Fast Track** and **ProXpress**

Additional 8190 Pulls Available in Fast Track and ProXpress				
MODELNUMBER	DESCRIPTION	SIZE	FINISH	Price
8190HD-0	90 Degree Offset Door Pull 1-3/4" (Mounting Type O)	10"	US32D	\$128.90
8190HD-2	90 Degree Offset Door Pull 1-3/4" (Mounting Type O)	12"	US32D	136.50

MODEL	PULL CTC	SUBSTRATE	MODEL NUMBER	BHMA FINISH	WEIGHT	MUST BE ORDERED IN MULTIPLE QTY	MULTIPLE QTY	PACKED PER BOX	LIST PRICE	
									EACH	PACKAGE
8190EZHD 90 Offset Door Pull 1" Round, 2-1/2" Clearance Antimicrobial Coating US26D-AM or US32D-AM available. See page 68 for optional mounting types and pricing.	8"	Brass	8190EZHD-8 US3	605	-	-	1	-	\$134.00	-
			8190EZHD-8 US4	606	-	-	1	-	134.00	-
			8190EZHD-8 US10	612	-	-	1	-	154.50	-
			8190EZHD-8 US10B	613	-	-	1	-	154.50	-
			8190EZHD-8 US26	625	-	-	1	-	142.00	-
		8190EZHD-8 US26D	626	-	-	1	-	142.00	-	
		316 Stainless	8190EZHD-8 US15	619	-	-	1	-	154.50	-
			8190EZHD-8 32-316	629-316	-	-	1	-	140.80	-
	8190EZHD-8 32D-316		630-316	-	-	1	-	116.20	-	
	10"	Brass	8190EZHD-0 US3	605	-	-	1	-	146.10	-
			8190EZHD-0 US4	606	-	-	1	-	146.10	-
			8190EZHD-0 US10	612	-	-	1	-	163.30	-
			8190EZHD-0 US10B	613	-	-	1	-	163.30	-
			8190EZHD-0 US26	625	-	-	1	-	154.50	-
		8190EZHD-0 US26D	626	-	-	1	-	154.50	-	
		316 Stainless	8190EZHD-0 US15	619	-	-	1	-	163.30	-
8190EZHD-0 32-316			629-316	-	-	1	-	150.70	-	
8190EZHD-0 32D-316**	630-316		-	-	1	-	126.00	-		
12"	Brass	8190EZHD-2 US3	605	-	-	1	-	154.50	-	
		8190EZHD-2 US4	606	-	-	1	-	154.50	-	
		8190EZHD-2 US10	612	-	-	1	-	175.70	-	
		8190EZHD-2 US10B	613	-	-	1	-	175.70	-	
		8190EZHD-2 US26	625	-	-	1	-	167.50	-	
	8190EZHD-2 US26D	626	-	-	1	-	167.50	-		
	316 Stainless	8190EZHD-2 US15	619	-	-	1	-	175.70	-	
		8190EZHD-2 32-316	629-316	-	-	1	-	160.70	-	
8190EZHD-2 32D-316		630-316	-	-	1	-	136.00	-		
18"	Brass	8190EZHD-18 US3	605	-	-	1	-	209.20	-	
		8190EZHD-18 US4	606	-	-	1	-	209.20	-	
		8190EZHD-18 US10	612	-	-	1	-	234.30	-	
		8190EZHD-18 US10B	613	-	-	1	-	234.30	-	
		8190EZHD-18 US26	625	-	-	1	-	221.50	-	
	8190EZHD-18 US26D	626	-	-	1	-	221.50	-		
	316 Stainless	8190EZHD-18 US15	619	-	-	1	-	234.30	-	
		8190EZHD-18 32-316	629-316	-	-	1	-	217.40	-	
8190EZHD-18 32D-316		630-316	-	-	1	-	192.90	-		
			8190EZHD-18 643E/716	-	-			234.30	-	
			8190EZHD-18 BLK	-	-			209.20	-	

Lead time exception: ** Products are stocked and will typically ship within 3 days

Bold pricing indicates item is in stock and available for **Fast Track** and **ProXpress**

MODEL	PLATE SIZE	SUBSTRATE	MODEL NUMBER	BHMA FINISH	WEIGHT	MUST BE ORDERED IN MULTIPLE QTY	MULTIPLE QTY	PACKED PER BOX	LIST PRICE	
									EACH	PACKAGE
8200 Push Plate Antimicrobial Coating Available Specify US26D AM or US32D AM See page 68 for pricing.	3x12" (89x306mm)	Brass	8200 US3	605	-	-	-	-	\$23.70	-
			8200 US4	606	-	-	-	-	23.70	-
			8200 US10	612	-	-	-	-	26.40	-
			8200 US10B	613	-	-	-	-	29.50	-
			8200 US26	625	-	-	-	-	29.50	-
			8200 US26D	626	-	-	-	-	29.50	-
		Aluminum	8200 US28	628	-	-	-	-	14.90	-
		Stainless	8200 US15	619	-	-	-	-	29.50	-
			8200 US32D	630	-	-	-	-	14.60	-
	8200 BLK		-	-	-	-	-	23.70	-	
	3.5x15" (89x381mm)	Brass	8200 US3	605	-	-	-	-	26.00	-
			8200 US4	606	-	-	-	-	26.40	-
			8200 US10	612	-	-	-	-	31.20	-
			8200 US10B	613	-	-	-	-	32.10	-
			8200 US26	625	-	-	-	-	31.20	-
			8200 US26D	626	-	-	-	-	30.60	-
		Aluminum	8200 US28	628	-	-	-	-	12.20	-
		Stainless	8200 US15	619	-	-	-	-	32.10	-
			8200 US32D**	630	-	-	-	-	15.00	-
	8200 BLK		-	-	-	-	-	26.00	-	
	4x16" (102x408mm)	Brass	8200 US3	605	-	-	-	-	30.60	-
			8200 US4	606	-	-	-	-	30.60	-
			8200 US10	612	-	-	-	-	34.90	-
			8200 US10B**	613	-	-	-	-	36.30	-
			8200 US26	625	-	-	-	-	35.70	-
			8200 US26D**	626	-	-	-	-	34.90	-
		Aluminum	8200 US28	628	-	-	-	-	11.50	-
		Stainless	8200 US15	619	-	-	-	-	36.30	-
			8200 US32D**	630	-	-	-	-	17.50	-
	8200 BLK**		-	-	-	-	-	30.60	-	
	6x16" (153x408mm)	Brass	8200 US3	605	-	-	-	-	49.10	-
			8200 US4	606	-	-	-	-	49.10	-
			8200 US10	612	-	-	-	-	54.70	-
			8200 US10B	613	-	-	-	-	58.20	-
			8200 US26	625	-	-	-	-	52.10	-
			8200 US26D	626	-	-	-	-	52.10	-
		Aluminum	8200 US28	628	-	-	-	-	14.90	-
		Stainless	8200 US15	619	-	-	-	-	59.50	-
			8200 US32D**	630	-	-	-	-	23.90	-
	8200 BLK		-	-	-	-	-	49.10	-	
	8x16" (204x408mm)	Brass	8200 US3	605	-	-	-	-	60.60	-
			8200 US4	606	-	-	-	-	60.60	-
8200 US10			612	-	-	-	-	69.80	-	
8200 US10B			613	-	-	-	-	74.40	-	
8200 US26			625	-	-	-	-	68.20	-	
8200 US26D			626	-	-	-	-	68.20	-	
Aluminum		8200 US28	628	-	-	-	-	18.50	-	
Stainless		8200 US15	619	-	-	-	-	74.40	-	
		8200 US32D**	630	-	-	-	-	33.30	-	
	8200 BLK	-	-	-	-	-	60.60	-		

HINGES
 CONTINUOUS HINGES
 PIVOTS
 Numerical 1-059
 Numerical 59-437
 Numerical 438-1021
 Numerical 1152-8190
 Numerical 8200-9266

Lead time exception: ** Products are stocked and will typically ship within 3 days

Bold pricing indicates item is in stock and available for **Fast Track** and **ProXpress**

HINGES
 CONTINUOUS HINGES
 PIVOTS
 Numerical 1-059
 Numerical 59-437
 Numerical 438-1021
 Numerical 1152-8190
 Numerical 8200-9266

MODEL	PULL CTC	PLATE SIZE	SUBSTRATE	MODEL NUMBER	BHMA FINISH	WEIGHT	MUST BE ORDERED IN MULTIPLE PACKED			LIST PRICE	
							MULTIPLE QTY	QTY	PER BOX	EACH	PACKAGE
8281 Georgian Decorative Straight Pull 1" Dia. with 1 1/4" Dia. Grip See page 68 for optional mounting types and pricing. 	12"		Brass	8281-12-605	605	-	-	1	-	\$1,011.70	-
				8281-12-613	613	-	-	1	1,052.20	-	
				8281-12-619*	619	-	-	1	809.30	-	
				8281-12-625*	625	-	-	1	809.30	-	
				8281-12-626*	626	-	-	1	809.30	-	
				8281-12-628*	628	-	-	1	417.70	-	
			Aluminum	8281-12-630	630	-	-	1	809.30	-	
				8281-12-BLK*	-	-	-	1	809.30	-	
				Stainless Steel	8281-16-605	605	-	-	1	1,044.30	-
					8281-16-613	613	-	-	1	1,086.00	-
					8281-16-619*	619	-	-	1	835.50	-
					8281-16-625*	625	-	-	1	835.50	-
	8281-16-626*	626	-		-	1	835.50	-			
	8281-16-628*	628	-		-	1	433.50	-			
	16"	Brass	8281-16-630	630	-	-	1	835.50	-		
			8281-16-BLK*	-	-	-	1	835.50	-		
			Aluminum	8281-18-605	605	-	-	1	1,060.70	-	
				8281-18-613	613	-	-	1	1,103.00	-	
				8281-18-619*	619	-	-	1	848.50	-	
				8281-18-625*	625	-	-	1	848.50	-	
		8281-18-626*		626	-	-	1	848.50	-		
		8281-18-628*		628	-	-	1	441.20	-		
		Stainless Steel	8281-18-630	630	-	-	1	848.50	-		
			8281-18-BLK*	-	-	-	1	848.50	-		
18"			Brass	8302-6 US3	605	-	-	-	-	86.70	-
				8302-6 US4	606	-	-	-	-	86.70	-
	8302-6 US10			612	-	-	-	-	99.30	-	
	8302-6 US10B			613	-	-	-	-	103.20	-	
	8302-6 US26	625		-	-	-	-	98.30	-		
	8302-6 US26D	626		-	-	-	-	91.40	-		
	Aluminum	8302-6 US28	628	-	-	-	-	38.10	-		
		Stainless	8302-6 US15	619	-	-	-	-	103.20	-	
			8302-6 US32D	630	-	-	-	-	52.00	-	
			8302-6 643E/716	-	-	-	-	-	103.20	-	
			8302-6 BLK	-	-	-	-	-	86.70	-	
			6"	Brass	8302-6 US3	605	-	-	-	-	91.40
8302-6 US4	606				-	-	-	-	91.40	-	
8302-6 US10	612	-			-	-	-	103.60	-		
8302-6 US10B	613	-			-	-	-	107.50	-		
8302-6 US26	625	-			-	-	-	103.00	-		
8302-6 US26D	626	-			-	-	-	95.70	-		
Aluminum	8302-6 US28	628		-	-	-	-	37.50	-		
	Stainless	8302-6 US15		619	-	-	-	-	107.50	-	
		8302-6 US32D**		630	-	-	-	-	54.20	-	
		8302-6 643E/716		-	-	-	-	-	107.50	-	
		8302-6 BLK		-	-	-	-	-	91.40	-	
		6"		Brass	8302-6 US3	605	-	-	-	-	109.30
8302-6 US4			606		-	-	-	-	109.30	-	
8302-6 US10	612		-		-	-	-	122.80	-		
8302-6 US10B	613		-		-	-	-	129.80	-		
8302-6 US26	625		-		-	-	-	119.30	-		
8302-6 US26D	626		-		-	-	-	112.20	-		
Aluminum	8302-6 US28		628	-	-	-	-	40.60	-		
	Stainless		8302-6 US15	619	-	-	-	-	129.80	-	
			8302-8 US32D	630	-	-	-	-	63.20	-	
			8302-6 643E/716	-	-	-	-	-	129.80	-	
			8302-6 BLK	-	-	-	-	-	109.30	-	
			8"	Brass	8302-8 US3	605	-	-	-	-	93.80
8302-8 US4		606			-	-	-	-	93.80	-	
8302-8 US10	612	-			-	-	-	107.70	-		
8302-8 US10B	613	-			-	-	-	112.00	-		
8302-8 US26	625	-			-	-	-	105.60	-		
8302-8 US26D	626	-			-	-	-	98.30	-		
Aluminum	8302-8 US28	628		-	-	-	-	37.30	-		
	Stainless	8302-8 US15		619	-	-	-	-	112.00	-	
		8302-8 US32D		630	-	-	-	-	56.60	-	
		8302-8 643E/716		-	-	-	-	-	112.00	-	
		8302-8 BLK		-	-	-	-	-	93.80	-	

Continued on next page.

Lead time exception: ** Products are stocked and will typically ship in 3-5 days
 *Finishes marked may date up to 4-5 weeks for shipment.

Bold pricing indicates item is in stock and available for **Fast Track** and **ProXpress**

MODEL	PULL CTC	PLATE SIZE	SUBSTRATE	MODEL NUMBER	BHMA FINISH	WEIGHT	MUST BE ORDERED IN			LIST PRICE	
							MULTIPLE QTY	MULTIPLE QTY	PACKED PER BOX	EACH	PACKAGE
8302 Pull Plate See page 68 for optional mounting types and pricing. Continued from previous page.	8"	4x16" (102x408mm)	Brass	8302-8 US3	605	-	-	-	-	\$98.30	-
				8302-8 US4	606	-	-	-	-	98.30	-
				8302-8 US10	612	-	-	-	-	112.50	-
				8302-8 US10B	613	-	-	-	-	111.60	-
				8302-8 US26	625	-	-	-	-	110.10	-
				8302-8 US26D	626	-	-	-	-	103.00	-
			Aluminum	8302-8 US28	628	-	-	-	-	38.20	-
				8302-8 US15	619	-	-	-	-	116.40	-
			Stainless	8302-8 US32D**	630	-	-	-	-	58.80	-
				8302-8 643E/716	-	-	-	-	-	111.60	-
				8302-8 BLK	-	-	-	-	-	98.30	-
				8302-8 US3	605	-	-	-	-	116.30	-
	6x16" (153x408mm)	Brass	8302-8 US4	606	-	-	-	-	116.30	-	
			8302-8 US10	612	-	-	-	-	131.60	-	
			8302-8 US10B	613	-	-	-	-	138.70	-	
			8302-8 US26	625	-	-	-	-	126.30	-	
			8302-8 US26D	626	-	-	-	-	119.30	-	
			Aluminum	8302-8 US28	628	-	-	-	-	41.30	-
		Stainless	8302-8 US15	619	-	-	-	-	138.70	-	
			8302-8 US32D	630	-	-	-	-	68.00	-	
			8302-8 643E/716	-	-	-	-	-	138.70	-	
			8302-8 BLK	-	-	-	-	-	116.30	-	
		3.5x15" (89x381mm)	Brass	8302-0 US3	605	-	-	-	-	104.70	-
				8302-0 US4	606	-	-	-	-	104.70	-
	8302-0 US10			612	-	-	-	-	120.60	-	
	8302-0 US10B			613	-	-	-	-	124.70	-	
	8302-0 US26			625	-	-	-	-	107.40	-	
	8302-0 US26D			626	-	-	-	-	107.70	-	
	Aluminum		8302-0 US28	628	-	-	-	-	40.60	-	
			8302-0 US15	619	-	-	-	-	124.70	-	
	Stainless		8302-0 US32D	630	-	-	-	-	63.30	-	
			8302-0 643E/716	-	-	-	-	-	124.70	-	
			8302-0 BLK	-	-	-	-	-	104.70	-	
			8302-0 US3	605	-	-	-	-	109.40	-	
	4x16" (102x408mm)	Brass	8302-0 US4	606	-	-	-	-	109.40	-	
			8302-0 US10	612	-	-	-	-	125.30	-	
			8302-0 US10B	613	-	-	-	-	129.10	-	
			8302-0 US26	625	-	-	-	-	112.00	-	
			8302-0 US26D	626	-	-	-	-	112.50	-	
			Aluminum	8302-0 US28	628	-	-	-	-	39.80	-
		Stainless	8302-0 US15	619	-	-	-	-	129.10	-	
			8302-0 US32D**	630	-	-	-	-	65.50	-	
8302-0 643E/716			-	-	-	-	-	129.10	-		
8302-0 BLK			-	-	-	-	-	109.40	-		
6x16" (153x408mm)		Brass	8302-0 US3	605	-	-	-	-	127.30	-	
			8302-0 US4	606	-	-	-	-	127.30	-	
	8302-0 US10		612	-	-	-	-	144.40	-		
	8302-0 US10B		613	-	-	-	-	151.30	-		
	8302-0 US26		625	-	-	-	-	128.20	-		
	8302-0 US26D		626	-	-	-	-	128.80	-		
	Aluminum	8302-0 US28	628	-	-	-	-	43.00	-		
		8302-0 US15	619	-	-	-	-	151.30	-		
	Stainless	8302-0 US32D	630	-	-	-	-	71.80	-		
		8302-0 643E/716	-	-	-	-	-	151.30	-		
		8302-0 BLK	-	-	-	-	-	127.30	-		



HINGES
 CONTINUOUS HINGES
 PIVOTS
 Numerical 1-059
 Numerical 59-437
 Numerical 438-1021
 Numerical 1152-8190
 Numerical 8200-9266

Lead time exception: ** Products are stocked and will typically ship within 3 days

Bold pricing indicates item is in stock and available for **Fast Track** and **ProXpress**



HINGES
 CONTINUOUS HINGES
 PIVOTS
 Numerical 1-059
 Numerical 59-437
 Numerical 438-1021
 Numerical 1152-8190
 Numerical 8200-9266

MODEL	PULL CTC	PLATE SIZE	SUBSTRATE	MODEL NUMBER	BHMA FINISH	WEIGHT	MUST BE ORDERED IN			LIST PRICE				
							MULTIPLE QTY	MULTIPLE QTY	PACKED PER BOX	EACH	PACKAGE			
8303 Pull Plate Antimicrobial Coating US26D-AM or US32D-AM available. See page 68 for optional mounting types and pricing.		8"	3.5x15" (89x381mm)	Brass	8303-8 US3	605	-	-	-	-	\$143.90	-		
					8303-8 US4	606	-	-	-	-	143.90	-		
					8303-8 US10	612	-	-	-	-	163.10	-		
					8303-8 US10B	613	-	-	-	-	169.00	-		
					8303-8 US26	625	-	-	-	-	155.90	-		
					8303-8 US26D	626	-	-	-	-	148.80	-		
				Aluminum	8303-8 US28	628	-	-	-	-	48.30	-		
				Stainless	8303-8 US15	619	-	-	-	-	169.00	-		
					8303-8 US32D	630	-	-	-	-	88.90	-		
					8303-8 643E/716	-	-	-	-	-	169.00	-		
					8303-8 BLK	-	-	-	-	-	143.90	-		
					8303-8 US3	605	-	-	-	-	148.50	-		
				8"	4x16" (102x408mm)	Brass	8303-8 US4	606	-	-	-	-	148.50	-
							8303-8 US10	612	-	-	-	-	167.30	-
							8303-8 US10B	613	-	-	-	-	173.50	-
8303-8 US26	625	-	-				-	-	160.40	-				
8303-8 US26D	626	-	-				-	-	153.50	-				
Aluminum	8303-8 US28	628	-				-	-	-	47.50	-			
Stainless	8303-8 US15	619	-			-	-	-	173.50	-				
	8303-8 US32D**	630	-			-	-	-	87.80	-				
	8303-8 643E/716	-	-			-	-	-	173.50	-				
	8303-8 BLK	-	-			-	-	-	148.50	-				
	8303-8 US3	605	-			-	-	-	166.50	-				
8"	6x16" (153x408mm)	Brass	8303-8 US4			606	-	-	-	-	166.50	-		
			8303-8 US10			612	-	-	-	-	186.60	-		
			8303-8 US10B			613	-	-	-	-	195.60	-		
			8303-8 US26			625	-	-	-	-	176.60	-		
			8303-8 US26D	626	-	-	-	-	169.70	-				
			Aluminum	8303-8 US28	628	-	-	-	-	50.60	-			
		Stainless	8303-8 US15	619	-	-	-	-	195.60	-				
			8303-8 US32D	630	-	-	-	-	97.90	-				
			8303-8 643E/716	-	-	-	-	-	195.60	-				
			8303-8 BLK	-	-	-	-	-	166.50	-				
			8303-0 US3	605	-	-	-	-	156.00	-				
		10"	3.5x15" (89x381mm)	Brass	8303-0 US4	606	-	-	-	-	156.00	-		
					8303-0 US10	612	-	-	-	-	179.50	-		
					8303-0 US10B	613	-	-	-	-	181.20	-		
					8303-0 US26	625	-	-	-	-	167.30	-		
8303-0 US26D	626				-	-	-	-	160.50	-				
Aluminum	8303-0 US28				628	-	-	-	-	50.10	-			
Stainless	8303-0 US15			619	-	-	-	-	186.10	-				
	8303-0 US32D			630	-	-	-	-	93.70	-				
	8303-0 643E/716			-	-	-	-	-	181.20	-				
	8303-0 BLK			-	-	-	-	-	156.00	-				
	8303-0 US3			605	-	-	-	-	160.50	-				
10"	4x16" (102x408mm)			Brass	8303-0 US4	606	-	-	-	-	160.50	-		
					8303-0 US10	612	-	-	-	-	184.10	-		
					8303-0 US10B	613	-	-	-	-	177.90	-		
					8303-0 US26	625	-	-	-	-	172.00	-		
		8303-0 US26D	626		-	-	-	-	164.90	-				
		Aluminum	8303-0 US28		628	-	-	-	-	49.30	-			
		Stainless	8303-0 US15	619	-	-	-	-	190.30	-				
			8303-0 US32D**	630	-	-	-	-	96.00	-				
			8303-0 643E/716	-	-	-	-	-	177.90	-				
			8303-0 BLK	-	-	-	-	-	160.50	-				

Continued on next page.

Lead time exception: ** Products are stocked and will typically ship within 3 days

Bold pricing indicates item is in stock and available for **Fast Track** and **ProXpress**

MODEL	PULL CTC	PLATE SIZE	SUBSTRATE	MODEL NUMBER	BHMA FINISH	WEIGHT	MUST BE ORDERED IN			LIST PRICE			
							MULTIPLE QTY	MULTIPLE QTY	PACKED PER BOX	EACH	PACKAGE		
8303 Pull Plate <i>Continued from previous page.</i> 	10"	6x16" (153x408mm)	Brass	8303-0 US3	605	-	-	-	-	\$178.50	-		
				8303-0 US4	606	-	-	-	-	178.50	-		
				8303-0 US10	612	-	-	-	-	203.20	-		
				8303-0 US10B	613	-	-	-	-	207.80	-		
				8303-0 US26	625	-	-	-	-	188.20	-		
			8303-0 US26D	626	-	-	-	-	181.50	-			
			Aluminum	8303-0 US28	628	-	-	-	-	52.40	-		
			Stainless	8303-0 US15	619	-	-	-	-	-	212.80	-	
				8303-0 US32D	630	-	-	-	-	-	102.20	-	
				8303-0 643E/716	-	-	-	-	-	-	207.80	-	
8303-0 BLK	-	-		-	-	-	-	178.50	-				
8305 Pull Plate Antimicrobial Coating US26D-AM or US32D-AM available. See page 68 for optional mounting types and pricing. 	6"	3.5x15" (89x381mm)	Brass	8305-6 US3	605	-	-	-	-	91.80	-		
				8305-6 US4	606	-	-	-	-	91.80	-		
				8305-6 US10	612	-	-	-	-	110.70	-		
				8305-6 US10B	613	-	-	-	-	114.30	-		
				8305-6 US26	625	-	-	-	-	96.80	-		
			8305-6 US26D	626	-	-	-	-	91.50	-			
			Aluminum	8305-6 US28	628	-	-	-	-	41.30	-		
			Stainless	8305-6 US15	619	-	-	-	-	-	114.30	-	
				8305-6 US32D	630	-	-	-	-	-	65.70	-	
				8305-6 643E/716	-	-	-	-	-	-	114.30	-	
				8305-6 BLK	-	-	-	-	-	-	91.80	-	
				8305-6 US3	605	-	-	-	-	-	96.40	-	
			6"	4x16" (102x408mm)	Brass	8305-6 US4	606	-	-	-	-	96.40	-
						8305-6 US10	612	-	-	-	-	115.10	-
						8305-6 US10B	613	-	-	-	-	118.60	-
	8305-6 US26	625				-	-	-	-	101.30	-		
	8305-6 US26D	626				-	-	-	-	96.00	-		
	Aluminum	8305-6 US28			628	-	-	-	-	40.70	-		
	Stainless	8305-6 US15			619	-	-	-	-	-	118.60	-	
		8305-6 US32D			630	-	-	-	-	-	65.40	-	
		8305-6 643E/716			-	-	-	-	-	-	118.60	-	
		8305-6 BLK			-	-	-	-	-	-	96.40	-	
		6"			6x16" (153x408mm)	Brass	8305-6 US3	605	-	-	-	-	114.30
	8305-6 US4						606	-	-	-	-	114.40	-
	8305-6 US10						612	-	-	-	-	134.70	-
	8305-6 US10B						613	-	-	-	-	141.10	-
	8305-6 US26						625	-	-	-	-	117.70	-
	8305-6 US26D		626	-		-	-	-	112.50	-			
	Aluminum		8305-6 US28	628		-	-	-	-	43.80	-		
	Stainless		8305-6 US15	619		-	-	-	-	-	141.10	-	
8305-6 US32D			630	-		-	-	-	-	74.90	-		
8305-6 643E/716			-	-		-	-	-	-	141.10	-		
8305-6 BLK		-	-	-	-	-	-	114.40	-				
8"		3.5x15" (89x381mm)	Brass	8305-8 US3	605	-	-	-	-	126.30	-		
	8305-8 US4			606	-	-	-	-	126.30	-			
	8305-8 US10			612	-	-	-	-	139.30	-			
	8305-8 US10B			613	-	-	-	-	140.90	-			
	8305-8 US26			625	-	-	-	-	135.20	-			
	8305-8 US26D		626	-	-	-	-	135.20	-				
	Aluminum		8305-8 US28	628	-	-	-	-	47.60	-			
	Stainless		8305-8 US15	619	-	-	-	-	-	140.90	-		
			8305-8 US32D	630	-	-	-	-	-	87.80	-		
			8305-8 643E/716	-	-	-	-	-	-	140.90	-		
8305-8 BLK		-	-	-	-	-	-	126.30	-				

HINGES
 CONTINUOUS HINGES
 PIVOTS
 Numerical 1-059
 Numerical 59-437
 Numerical 438-1021
 Numerical 1152-8190
 Numerical 8200-9266

Lead time exception: ** Products are stocked and will typically ship within 3 days



Bold pricing indicates item is in stock and available for **Fast Track** and **ProXpress**

HINGES
 CONTINUOUS HINGES
 PIVOTS
 Numerical 1-059
 Numerical 59-437
 Numerical 438-1021
 Numerical 1152-8190
 Numerical 8200-9266

MODEL	PULL CTC	PLATE SIZE	SUBSTRATE	MODEL NUMBER	BHMA FINISH	WEIGHT	MUST BE ORDERED IN			LIST PRICE	
							MULTIPLE QTY	MULTIPLE QTY	PACKED PER BOX	EACH	PACKAGE
8305 Pull Plate <i>Continued from previous page.</i> 	8"	4x16" (102x408mm)	Brass	8305-8 US3	605	-	-	-	-	\$131.00	-
				8305-8 US4	606	-	-	-	-	131.00	-
				8305-8 US10	612	-	-	-	-	143.90	-
				8305-8 US10B	613	-	-	-	-	145.40	-
				8305-8 US26	625	-	-	-	-	139.50	-
				8305-8 US26D	626	-	-	-	-	139.50	-
			Aluminum	8305-8 US28	628	-	-	-	-	47.00	-
			Stainless	8305-8 US15	619	-	-	-	-	145.40	-
				8305-8 US32D**	630	-	-	-	-	86.40	-
	8305-8 643E/716	-		-	-	-	-	145.40	-		
	8305-8 BLK	-	-	-	-	-	-	131.00	-		
	8"	6x16" (153x408mm)	Brass	8305-8 US3	605	-	-	-	-	148.80	-
				8305-8 US4	606	-	-	-	-	148.80	-
				8305-8 US10	612	-	-	-	-	163.30	-
				8305-8 US10B	613	-	-	-	-	167.50	-
				8305-8 US26	625	-	-	-	-	156.00	-
				8305-8 US26D	626	-	-	-	-	156.00	-
			Aluminum	8305-8 US28	628	-	-	-	-	50.20	-
Stainless			8305-8 US15	619	-	-	-	-	167.50	-	
			8305-8 US32D	630	-	-	-	-	96.60	-	
	8305-8 643E/716	-	-	-	-	-	167.50	-			
8305-8 BLK	-	-	-	-	-	-	148.80	-			
10"	3.5x15" (89x381mm)	Brass	8305-0 US3	605	-	-	-	-	134.90	-	
			8305-0 US4	606	-	-	-	-	134.90	-	
			8305-0 US10	612	-	-	-	-	151.90	-	
			8305-0 US10B	613	-	-	-	-	153.60	-	
			8305-0 US26	625	-	-	-	-	143.70	-	
			8305-0 US26D	626	-	-	-	-	143.70	-	
		Aluminum	8305-0 US28	628	-	-	-	-	48.90	-	
		Stainless	8305-0 US15	619	-	-	-	-	153.60	-	
			8305-0 US32D	630	-	-	-	-	96.30	-	
8305-0 643E/716	-		-	-	-	-	153.60	-			
8305-0 BLK	-	-	-	-	-	-	134.90	-			
10"	4x16" (102x408mm)	Brass	8305-0 US3	605	-	-	-	-	139.30	-	
			8305-0 US4	606	-	-	-	-	139.30	-	
			8305-0 US10	612	-	-	-	-	156.50	-	
			8305-0 US10B	613	-	-	-	-	157.90	-	
			8305-0 US26	625	-	-	-	-	148.30	-	
			8305-0 US26D	626	-	-	-	-	148.30	-	
		Aluminum	8305-0 US28	628	-	-	-	-	48.00	-	
		Stainless	8305-0 US15	619	-	-	-	-	157.90	-	
			8305-0 US32D**	630	-	-	-	-	94.50	-	
8305-0 643E/716	-		-	-	-	-	157.90	-			
8305-0 BLK	-	-	-	-	-	-	139.30	-			
10"	6x16" (153x408mm)	Brass	8305-0 US3	605	-	-	-	-	157.20	-	
			8305-0 US4	606	-	-	-	-	157.20	-	
			8305-0 US10	612	-	-	-	-	175.80	-	
			8305-0 US10B	613	-	-	-	-	180.10	-	
			8305-0 US26	625	-	-	-	-	164.40	-	
			8305-0 US26D	626	-	-	-	-	164.40	-	
		Aluminum	8305-0 US28	628	-	-	-	-	51.10	-	
		Stainless	8305-0 US15	619	-	-	-	-	180.10	-	
			8305-0 US32D	630	-	-	-	-	105.00	-	
8305-0 643E/716	-		-	-	-	-	180.10	-			
8305-0 BLK	-	-	-	-	-	-	157.20	-			

Lead time exception: ** Products are stocked and will typically ship within 3 days

Bold pricing indicates item is in stock and available for **Fast Track** and **ProXpress**



MODEL	PULL CTC	PLATE SIZE	SUBSTRATE	MODEL NUMBER	BHMA FINISH	WEIGHT	MUST BE ORDERED IN			LIST PRICE			
							MULTIPLE QTY	MULTIPLE QTY	PACKED PER BOX	EACH	PACKAGE		
8311 Pull Plate Antimicrobial Coating US26D-AM or US32D-AM available. See page 68 for optional mounting types and pricing. 	5" (Actual CTC = 5-1/4")	3.5x15" (89x381mm)	Brass	8311-5 US3	605	-	-	-	-	\$88.50	-		
				8311-5 US4	606	-	-	-	-	88.50	-		
				8311-5 US10	612	-	-	-	-	99.90	-		
				8311-5 US10B	613	-	-	-	-	101.50	-		
				8311-5 US26	625	-	-	-	-	93.10	-		
				8311-5 US26D	626	-	-	-	-	97.10	-		
			Aluminum	8311-5 US28	628	-	-	-	-	52.10	-		
			Stainless	8311-5 US15	619	-	-	-	-	-	101.50	-	
	8311-5 US32D	630		-	-	-	-	-	72.90	-			
	8311-5 643E/716	-		-	-	-	-	-	101.50	-			
	8311-5 BLK	-		-	-	-	-	-	88.50	-			
	5" (Actual CTC = 5-1/4")	4x16" (102x408mm)	Brass	8311-5 US3	605	-	-	-	-	-	93.10	-	
				8311-5 US4	606	-	-	-	-	-	93.10	-	
				8311-5 US10	612	-	-	-	-	-	104.50	-	
8311-5 US10B				613	-	-	-	-	-	106.00	-		
8311-5 US26				625	-	-	-	-	-	97.60	-		
8311-5 US26D				626	-	-	-	-	-	101.60	-		
Aluminum			8311-5 US28	628	-	-	-	-	-	51.20	-		
Stainless			8311-5 US15	619	-	-	-	-	-	-	106.00	-	
			8311-5 US32D	630	-	-	-	-	-	-	72.20	-	
			8311-5 643E/716	-	-	-	-	-	-	-	106.00	-	
			8311-5 BLK	-	-	-	-	-	-	-	93.10	-	
5" (Actual CTC = 5-1/4")			6x16" (153x408mm)	Brass	8311-5 US3	605	-	-	-	-	-	110.90	-
					8311-5 US4	606	-	-	-	-	-	110.90	-
					8311-5 US10	612	-	-	-	-	-	123.80	-
	8311-5 US10B	613			-	-	-	-	-	128.20	-		
	8311-5 US26	625			-	-	-	-	-	113.90	-		
	8311-5 US26D	626			-	-	-	-	-	118.00	-		
	Aluminum	8311-5 US28		628	-	-	-	-	-	54.30	-		
	Stainless	8311-5 US15		619	-	-	-	-	-	-	128.20	-	
		8311-5 US32D		630	-	-	-	-	-	-	82.00	-	
		8311-5 643E/716		-	-	-	-	-	-	-	128.20	-	
		8311-5 BLK		-	-	-	-	-	-	-	110.90	-	
	8312 Plymouth Decorative Curved Pull - 1" Dia. See page 68 for optional mounting types and pricing. 	12"			Brass	8312-12-605	605	-	-	1		369.90	-
						8312-12-613	613	-	-	1		449.20	-
						8312-12-619*	619	-	-	1		449.20	-
8312-12-625*			625			-	-	1		449.20	-		
8312-12-626*			626			-	-	1		449.20	-		
Stainless Steel			8312-12-630		630	-	-	1		1,044.30	-		
			8312-12-BLK*		-	-	-	1		449.20	-		
8320 Plymouth Decorative Curved Pull - 1 1/4" Dia. See page 68 for optional mounting types and pricing. 	20"		Brass	8320-20-605	605	-	-	1		686.90	-		
				8320-20-613	613	-	-	1		739.90	-		
				8320-20-619*	619	-	-	1		739.90	-		
				8320-20-625*	625	-	-	1		739.90	-		
				8320-20-626*	626	-	-	1		739.90	-		
			Stainless Steel	8320-20-630	630	-	-	1		1,175.00	-		
				8320-20-BLK*	-	-	-	1		739.90	-		

HINGES
 CONTINUOUS HINGES
 PIVOTS
 Numerical 1-059
 Numerical 59-437
 Numerical 438-1021
 Numerical 1152-8190
 Numerical 8200-9266

Lead time exception: ** Products are stocked and will typically ship in 3-5 days
 *Finishes marked may date up to 4-5 weeks for shipment.

Bold pricing indicates item is in stock and available for **Fast Track** and **ProXpress**

HINGES
 CONTINUOUS HINGES
 PIVOTS
 Numerical 1-059
 Numerical 59-437
 Numerical 438-1021
 Numerical 1152-8190
 Numerical 8200-9266

MODEL	PULL CTC	PLATE SIZE	SUBSTRATE	MODEL NUMBER	BHMA FINISH	WEIGHT	MUST BE ORDERED IN			LIST PRICE	
							MULTIPLE QTY	MULTIPLE QTY	PACKED PER BOX	EACH	PACKAGE
8371 Addison Decorative Flat Tip, Straight Pull 1" Dia. See page 68 for optional mounting types and pricing. 	12"		Brass	8371-12-605	605	-	-	1	-	\$835.50	-
				8371-12-613	613	-	-	1	-	835.50	-
				8371-12-619*	619	-	-	1	-	835.50	-
				8371-12-625*	625	-	-	1	-	835.50	-
				8371-12-626*	626	-	-	1	-	835.40	-
				8371-12-BLK*	622	-	-	1	-	835.50	-
	18"		Brass	8371-18-605	605	-	-	1	-	882.40	-
				8371-18-613	613	-	-	1	-	882.40	-
				8371-18-619*	619	-	-	1	-	882.40	-
				8371-18-625*	625	-	-	1	-	882.40	-
				8371-18-626*	626	-	-	1	-	882.40	-
				8371-18-BLK*	622	-	-	1	-	882.40	-
	24"		Brass	8371-24-605	605	-	-	1	-	914.00	-
				8371-24-613	613	-	-	1	-	914.00	-
				8371-24-619*	619	-	-	1	-	914.00	-
				8371-24-625*	625	-	-	1	-	914.00	-
				8371-24-626*	626	-	-	1	-	914.00	-
				8371-24-BLK*	622	-	-	1	-	914.00	-
8372 Camelot Decorative Steeple Tip, Straight Pull 1" Dia. See page 68 for optional mounting types and pricing. 	12"		Brass	8372-12-605	605	-	-	1	-	835.50	-
				8372-12-613	613	-	-	1	-	835.50	-
				8372-12-619*	619	-	-	1	-	835.50	-
				8372-12-625*	625	-	-	1	-	835.50	-
				8372-12-626*	626	-	-	1	-	835.40	-
				8372-12-BLK*	622	-	-	1	-	835.50	-
	18"		Brass	8372-18-605	605	-	-	1	-	882.40	-
				8372-18-613	613	-	-	1	-	882.40	-
				8372-18-619*	619	-	-	1	-	882.40	-
				8372-18-625*	625	-	-	1	-	882.40	-
				8372-18-626*	626	-	-	1	-	882.40	-
				8372-18-BLK*	622	-	-	1	-	882.40	-
	24"		Brass	8372-24-605	605	-	-	1	-	914.00	-
				8372-24-613	613	-	-	1	-	914.00	-
				8372-24-619*	619	-	-	1	-	914.00	-
				8372-24-625*	625	-	-	1	-	914.00	-
				8372-24-626*	626	-	-	1	-	914.00	-
				8372-24-BLK*	622	-	-	1	-	914.00	-
8373 Brookshire Decorative Acorn Tip, Straight Pull 1" Dia. See page 68 for optional mounting types and pricing. 	12"		Brass	8373-12-605	605	-	-	1	-	835.50	-
				8373-12-613	613	-	-	1	-	835.50	-
				8373-12-619*	619	-	-	1	-	835.50	-
				8373-12-625*	625	-	-	1	-	835.50	-
				8373-12-626*	626	-	-	1	-	835.40	-
				8373-12-BLK*	622	-	-	1	-	835.50	-
	18"		Brass	8373-18-605	605	-	-	1	-	882.40	-
				8373-18-613	613	-	-	1	-	882.40	-
				8373-18-619*	619	-	-	1	-	882.40	-
				8373-18-625*	625	-	-	1	-	882.40	-
				8373-18-626*	626	-	-	1	-	882.40	-
				8373-18-BLK*	622	-	-	1	-	882.40	-
	24"		Brass	8373-24-605	605	-	-	1	-	914.00	-
				8373-24-613	613	-	-	1	-	914.00	-
				8373-24-619*	619	-	-	1	-	914.00	-
				8373-24-625*	625	-	-	1	-	914.00	-
				8373-24-626*	626	-	-	1	-	914.00	-
				8373-24-BLK*	622	-	-	1	-	914.00	-

Lead time exception: ** Products are stocked and will typically ship in 3-5 days
 *Finishes marked may date up to 4-5 weeks for shipment.

Bold pricing indicates item is in stock and available for **Fast Track** and **ProXpress**

8400 Protection Plates Stocked Protection Plates

All protection plates come standard with 4 Beveled Edges and Counter Sunk Holes (B-CS) at no extra charge.

MODEL	SUBSTRATE	FINISH	PLATE SIZE	WEIGHT	MUST BE ORDERED IN MULTIPLE QTY	MULTIPLE QTY	PACKED PER BOX	LIST PRICE		
								EACH	PACKAGE	
8400	Brass	US10B	8X34	---	---	---	---	\$132.48	---	
			10X34	---	---	---	---	165.60	---	
	Stainless	BLK	10X34	---	---	---	---	---	124.82	---
			US32D	4X34	---	---	---	---	---	23.02
		4X35		---	---	---	---	---	24.37	---
		6X34		---	---	---	---	---	34.53	---
		6X35		---	---	---	---	---	36.55	---
		8X34		---	---	---	---	---	40.78	---
		8X34.5		---	---	---	---	---	43.20	---
		8X35		---	---	---	---	---	43.20	---
		8X40		---	---	---	---	---	47.99	---
		8X46		---	---	---	---	---	55.19	---
		10X22		---	---	---	---	---	33.00	---
		10X23		---	---	---	---	---	35.99	---
		10X28		---	---	---	---	---	42.00	---
		10X30		---	---	---	---	---	45.00	---
		10X32		---	---	---	---	---	47.99	---
		10X34		---	---	---	---	---	50.99	---
		10X34.5		---	---	---	---	---	53.99	---
		10X35		---	---	---	---	---	53.99	---
		10X38		---	---	---	---	---	56.98	---
		10X40	---	---	---	---	---	59.98	---	
		10X41	---	---	---	---	---	62.98	---	
		10X42	---	---	---	---	---	62.98	---	
		10X43	---	---	---	---	---	65.98	---	
		10X46	---	---	---	---	---	68.97	---	
		10X47	---	---	---	---	---	71.99	---	
		12X34	---	---	---	---	---	61.19	---	
		12X40	---	---	---	---	---	71.99	---	
		16X34	---	---	---	---	---	81.57	---	
30X34	---	---	---	---	---	166.04	---			
34X34	---	---	---	---	---	188.17	---			
34X35	---	---	---	---	---	199.24	---			
34X40	---	---	---	---	---	221.38	---			
34X46	---	---	---	---	---	254.59	---			
36X34	---	---	---	---	---	199.24	---			
36X46	---	---	---	---	---	269.56	---			

For all other Protection Plates, see pricing in the table on next page.

HINGES
 CONTINUOUS HINGES
 PIVOTS
 Numerical 1-059
 Numerical 59-437
 Numerical 438-1021
 Numerical 1152-8190
 Numerical 8200-9266

Contact Ives Customer Service for pricing on additional sizes and finishes

Bold pricing indicates item is in stock and available for **Fast Track** and **ProXpress**

8400 Protection Plates

All protection plates come standard with 4 Beveled Edges and Counter Sunk Holes (B-CS) at no extra charge.

8400 Protection Plate (List Price (Per 100 Square Inches))

FINISH	SUBSTRATE	MAX SIZE	UNDER 8"	8" ≤ 16"	OVER 16" ≤ 36"	OVER 36" ≤ 48"
US32D	Stainless	48 x 48"	17.70	15.60	17.00	\$17.00
US32	Stainless	48 x 48"	38.80	36.70	37.50	\$37.50
BLK	Stainless	24 x 48"	38.80	36.70	37.50	\$37.50
US3	Brass	24 x 48"	47.90	45.30	59.90	NA
US4	Brass	24 x 48"	47.90	45.30	59.90	NA
US10	Brass	24 x 48"	53.50	50.80	66.90	NA
US10B	Brass	36 x 48"	54.40	50.80	66.90	NA
US15	Stainless	24 x 48"	54.40	51.90	66.90	NA
US26	Stainless	36 x 48"	52.60	50.10	66.90	NA
US26D	Stainless	24 x 48"	52.60	50.10	66.90	NA
US28	Aluminum	48 x 48"	16.30	13.60	14.90	\$14.40
Clear	Plastic	48 x 48"	14.70	11.60	13.30	\$13.30
P-BLK	Plastic	48 x 48"	14.70	11.60	13.30	\$13.30
654	Satin Stainless Steel	48 x 48"	15.00	13.50	14.70	\$14.70

Kickplates must be ordered in 1/2" increments

8400 Options

MODEL	DESCRIPTION	SIZE	LIST ADD PER PLATE
B-CS	Hand Bevel Four Edges (B4E) and Counter Sunk Holes		Standard
B-NH	No Mounting Holes - US32D, US32, US3, US4, US28, Clear Plastic, Black Plastic only (Not available on 8402)		30.00
B-NHA	No Mounting Holes with Adhesive - US32D, US32, US3, US4, US28, Clear, Black only	12" and under over 12" up to 24"	30.00 61.00
TK-TX	Includes Self Drilling Tek Screws and Torx Brand Security Screws (package of 16 each)		15.00
ERS	Prepped for Extra Row of Screws (For extra mounting hole option, customer must specify location and quantity of holes required)		Consult Factory

MODEL	DESCRIPTION	SIZE	LIST ADD PER PLATE
8401	Gasket Tape Kit (sold separately)	Fits 8" x 34"	\$24.00 ea.
8402	UL Label Kickplate (not available on plastic kickplates)		21.00 ea.

Lead time exception: ** Products are stocked and will typically ship within 3 days

Bold pricing indicates item is in stock and available for **Fast Track** and **ProXpress**

Door Plate Hundred Square Inch Sizing Chart

width

height	inches	22	24	26	28	30	32	34	36	38	40	42	44	46	48
4	0.88	0.96	1.04	1.12	1.2	1.28	1.36	1.44	1.52	1.6	1.68	1.76	1.84	1.92	
6	1.32	1.44	1.56	1.68	1.8	1.92	2.04	2.16	2.28	2.4	2.52	2.64	2.76	2.88	
8	1.76	1.92	2.08	2.24	2.4	2.56	2.72	2.88	3.04	3.2	3.36	3.52	3.68	3.84	
10	2.2	2.4	2.6	2.8	3	3.2	3.4	3.60	3.80	4	4.2	4.4	4.6	4.8	
12	2.64	2.88	3.12	3.36	3.6	3.84	4.08	4.32	4.56	4.8	5.04	5.28	5.52	5.76	
14	3.08	3.36	3.64	3.92	4.2	4.48	4.76	5.04	5.32	5.6	5.88	6.16	6.44	6.72	
16	3.52	3.84	4.16	4.48	4.8	5.12	5.44	5.76	6.08	6.4	6.72	7.04	7.36	7.68	
18	3.96	4.32	4.68	5.04	5.4	5.76	6.12	6.48	6.84	7.2	7.56	7.92	8.28	8.64	
20	4.4	4.8	5.2	5.6	6	6.4	6.8	7.20	7.60	8	8.4	8.8	9.2	9.6	
22	4.84	5.28	5.72	6.16	6.6	7.04	7.48	7.92	8.36	8.8	9.24	9.68	10.12	10.56	
24	5.28	5.76	6.24	6.72	7.2	7.68	8.16	8.64	9.12	9.6	10.08	10.56	11.04	11.52	
26	5.72	6.24	6.76	7.28	7.8	8.32	8.84	9.36	9.88	10.4	10.92	11.44	11.96	12.48	
28	6.16	6.72	7.28	7.84	8.4	8.96	9.52	10.08	10.64	11.2	11.76	12.32	12.88	13.44	
30	6.6	7.2	7.8	8.4	9	9.6	10.2	10.80	11.40	12	12.6	13.2	13.8	14.4	
32	7.04	7.68	8.32	8.96	9.6	10.24	10.88	11.52	12.16	12.8	13.44	14.08	14.72	15.36	
34	7.48	8.16	8.84	9.52	10.2	10.88	11.56	12.24	12.92	13.6	14.28	14.96	15.64	16.32	
36	7.92	8.64	9.36	10.08	10.8	11.52	12.24	12.96	13.68	14.4	15.12	15.84	16.56	17.28	
38	8.36	9.12	9.88	10.64	11.4	12.16	12.92	13.68	14.44	15.2	15.96	16.72	17.48	18.24	
40	8.8	9.6	10.4	11.2	12	12.8	13.6	14.40	15.20	16	16.8	17.6	18.4	19.2	
42	9.24	10.08	10.92	11.76	12.6	13.44	14.28	15.12	15.96	16.8	17.64	18.48	19.32	20.16	
44	9.68	10.56	11.44	12.32	13.2	14.08	14.96	15.84	16.72	17.6	18.48	19.36	20.24	21.12	
46	10.12	11.04	11.96	12.88	13.8	14.72	15.64	16.56	17.48	18.4	19.32	20.24	21.16	22.08	
48	10.56	11.52	12.48	13.44	14.4	15.36	16.32	17.28	18.24	19.2	20.16	21.12	22.08	23.04	

How to price protection plates

1) Look to see if the desired plate is in the the Stocked table. If it is, use this price shown.

2) If the plate is not a stocked plate,

a) Determine the hundred square inch size using the Door Plate Hundred Square Inch Sizing Chart above. If ordering in increments not shown on the chart, use the next larger size (height and/or width) shown in the chart.

Example: For a 6 1/2" x 33 1/2" plate, use 8 x 34 = 2.72 sq. inches.

b) Determine the list price for the height of plate and desired finish from the List Price (per 100 square inches) table.

Example: For a 6 1/2" height plate in US32D finish, use Under 8" column = \$17.70

For base plate pricing, multiply square inch size from part a) times the list price from b)

Example = 2.72 sq. inches X \$17.70 = \$48.14

3) If any options are desired, then add the list add per plate pricing to the base plate pricing.

For a 8402 8 X 34 US32D TK-TX, use the following.

Examples = 2.72 sq. inches X \$15.60 (base price) + \$21.00 (for UL) + \$21.00 (for TK-TX) = \$84.43

Return Policy - requires prior approval, consult factory.

HINGES

CONTINUOUS HINGES

PIVOTS

Numerical 1-059

Numerical 59-437

Numerical 438-1021



Numerical 1152-8190

Numerical 8200-9266

Lead time exception: ** Products are stocked and will typically ship within 3 days

Bold pricing indicates item is in stock and available for **Fast Track** and **ProXpress**

HINGES
 CONTINUOUS HINGES
 PIVOTS
 Numerical 1-059
 Numerical 59-437
 Numerical 438-1021
 Numerical 1152-8190
 Numerical 8200-9266

MODEL	PULL CTC	SUBSTRATE	MODEL NUMBER	BHMA Finish	WEIGHT	Must Be Ordered in Multiple QTY	Multiple QTY	List Price	
								EACH	PACKAGE
8700 Greenwich Decorative Arc Straight Pull 3/4" Dia. See page 68 for optional mounting types and pricing. 	9"	Brass	8700-09-605	605	-	-	1	\$251.90	-
			8700-09-613	613	-	-	1	251.90	-
			8700-09-619*	619	-	-	1	251.90	-
			8700-09-625*	625	-	-	1	251.90	-
			8700-09-626*	626	-	-	1	251.90	-
		8700-09-630	630	-	-	1	245.00	-	
	12"	Brass	8700-12-605	605	-	-	1	262.20	-
			8700-12-613	613	-	-	1	262.20	-
			8700-12-619*	619	-	-	1	262.20	-
			8700-12-625*	625	-	-	1	262.20	-
			8700-12-626*	626	-	-	1	262.20	-
		8700-12-630	630	-	-	1	287.00	-	
	18"	Brass	8700-18-605	605	-	-	1	301.90	-
			8700-18-613	613	-	-	1	301.90	-
			8700-18-619*	619	-	-	1	301.90	-
			8700-18-625*	625	-	-	1	301.90	-
			8700-18-626*	626	-	-	1	301.90	-
		8700-18-630	630	-	-	1	275.70	-	
	24"	Brass	8700-24-605	605	-	-	1	301.90	-
			8700-24-613	613	-	-	1	301.90	-
			8700-24-619*	619	-	-	1	301.90	-
			8700-24-625*	625	-	-	1	301.90	-
			8700-24-626*	626	-	-	1	301.90	-
		8700-24-630	630	-	-	1	275.70	-	
8800 Greenwich Decorative Arc Offset Pull 3/4" Dia. See page 68 for optional mounting types and pricing. 	9"	Brass	8800-09-605	605	-	-	1	323.80	-
			8800-09-613	613	-	-	1	323.80	-
			8800-09-619*	619	-	-	1	323.80	-
			8800-09-625*	625	-	-	1	323.80	-
			8800-09-626*	626	-	-	1	323.80	-
		8800-09-630	630	-	-	1	313.40	-	
	12"	Brass	8800-12-605	605	-	-	1	343.50	-
			8800-12-613	613	-	-	1	343.50	-
			8800-12-619*	619	-	-	1	343.50	-
			8800-12-625*	625	-	-	1	343.50	-
			8800-12-626*	626	-	-	1	343.50	-
		8800-12-630	630	-	-	1	339.40	-	
	18"	Brass	8800-18-605	605	-	-	1	376.60	-
			8800-18-613	613	-	-	1	376.60	-
			8800-18-619*	619	-	-	1	376.60	-
			8800-18-625*	625	-	-	1	376.60	-
			8800-18-626*	626	-	-	1	376.60	-
		8800-18-630	630	-	-	1	365.50	-	
	24"	Brass	8800-24-605	605	-	-	1	462.20	-
			8800-24-613	613	-	-	1	462.20	-
			8800-24-619*	619	-	-	1	462.20	-
			8800-24-625*	625	-	-	1	462.20	-
			8800-24-626*	626	-	-	1	462.20	-
		8800-24-630	630	-	-	1	391.80	-	
8848 Latitude Decorative Straight Pull w/ Black Stand Offs - 1" Dia. See page 68 for optional mounting types and pricing. 	12"	Brass	8848-12-605	605	-	-	1	626.50	-
			8848-12-613	613	-	-	1	626.50	-
			8848-12-619*	619	-	-	1	626.50	-
			8848-12-625*	625	-	-	1	626.50	-
			8848-12-626*	626	-	-	1	626.50	-
		8848-12-630	630	-	-	1	522.20	-	
	12"	Stainless Steel	8848-12-630	630	-	-	1	522.20	-
			8848-12-BLK*	-	-	-	1	626.50	-
			8848-12-605	605	-	-	1	626.50	-
			8848-12-613	613	-	-	1	626.50	-
			8848-12-619*	619	-	-	1	626.50	-
		8848-12-625*	625	-	-	1	626.50	-	
12"	Aluminum	8975-12-628	628	-	-	1	626.50	-	
		8975-12-613	613	-	-	1	626.50	-	
		8975-12-619*	619	-	-	1	626.50	-	
		8975-12-625*	625	-	-	1	626.50	-	
		8975-12-626*	626	-	-	1	626.50	-	
	8975-12-630	630	-	-	1	522.20	-		

Lead time exception: ** Products are stocked and will typically ship in 3-5 days
 *Finishes marked may date up to 4-5 weeks for shipment.

Bold pricing indicates item is in stock and available for **Fast Track** and **ProXpress**

MODEL	PUSH CTC	PULL CTC	SUBSTRATE	FINISH	MODEL NUMBER	DESCRIPTION	WEIGHT	ORDER QTY	BOX QTY	LIST PRICE	
9100HD Push Bar, 1" Round, 2-1/2" Projection Pull Plate Custom Sizing Available in 1" increments. Fractional increments available as Engineered Specials. See page 68 for pricing Antimicrobial Coating US26D-AM or US32D-AM available. Standard with NS mounting; See page 68 for optional mounting types and pricing.	28"		Brass	605	9100HD-28-US3					\$258.60	
				606	9100HD-28-US4			258.60			
				612	9100HD-28-US10			304.80			
				613	9100HD-28-US10B			304.80			
				625	9100HD-28-US26			267.00			
			626	9100HD-28-US26D			267.00				
			Stainless	619	9100HD-28-US15			304.80			
				629	9100HD-28 32			211.60			
				630	9100HD-28 32D			186.70			
				-	9100HD-28-643E/716			304.80			
	-	9100HD-28-BLK				258.60					
	316 Stainless	629-316	9100HD-28-32-316			243.70					
		630-316	9100HD-28-32D-316			215.00					
	28"	33"	Brass	605	9100HD-33-US3						258.60
				606	9100HD-33-US4			258.60			
				612	9100HD-33-US10			304.80			
				613	9100HD-33-US10B			304.80			
				625	9100HD-33-US26			267.00			
				626	9100HD-33-US26D			267.00			
				Stainless	619	9100HD-33-US15			304.80		
629					9100HD-33 32			284.40			
630					9100HD-33 32D			186.70			
-					9100HD-33-643E/716			304.80			
316 Stainless			629-316	9100HD-33-32-316			327.40				
			630-316	9100HD-33-32D-316			215.00				
			Brass	605	9103EZHD-28-8-US3			392.50			
				606	9103EZHD-28-8-US4			392.50			
612				9103EZHD-28-8-US10			459.20				
613				9103EZHD-28-8-US10B			459.20				
625				9103EZHD-28-8-US26			409.00				
626				9103EZHD-28-8-US26D			409.00				
316 Stainless	619	9103EZHD-28-8-US15				459.20					
	629-316	9103EZHD-28-8-32-316				379.00					
	630-316	9103EZHD-28-8-32D-316				336.50					
	-	9103EZHD-28-8-643E/716				459.20					
28"	10"	Brass	605	9103EZHD-28-0-US3						370.40	
			606	9103EZHD-28-0-US4			390.70				
			612	9103EZHD-28-0-US10			390.70				
			613	9103EZHD-28-0-US10B			390.70				
			625	9103EZHD-28-0-US26			390.70				
		626	9103EZHD-28-0-US26D			390.70					
		316 Stainless	619	9103EZHD-28-0-US15			390.70				
			629-316	9103EZHD-28-0-32-316			389.50				
			630-316	9103EZHD-28-0-32D-316			346.60				
			-	9103EZHD-28-0-643E/716			390.70				
-	9103EZHD-28-0-BLK				370.40						
28"	12"	Brass	605	9103EZHD-28-2-US3						387.10	
			606	9103EZHD-28-2-US4			387.10				
			612	9103EZHD-28-2-US10			449.80				
			613	9103EZHD-28-2-US10B			449.80				
			625	9103EZHD-28-2-US26			399.60				
		626	9103EZHD-28-2-US26D			399.60					
		316 Stainless	619	9103EZHD-28-2-US15			449.80				
			629-316	9103EZHD-28-2-32-316			399.80				
			630-316	9103EZHD-28-2-32D-316			356.60				
			-	9103EZHD-28-2-643E/716			449.80				
-	9103EZHD-28-2-BLK				387.10						
33"	8"	Brass	605	9103EZHD-33-8-US3						392.50	
			606	9103EZHD-33-8-US4			392.50				
			612	9103EZHD-33-8-US10			459.20				
			613	9103EZHD-33-8-US10B			459.20				
			625	9103EZHD-33-8-US26			409.00				
		626	9103EZHD-33-8-US26D			409.00					
		316 Stainless	619	9103EZHD-33-8-US15			459.20				
			629-316	9103EZHD-33-8-32-316			462.70				
			630-316	9103EZHD-33-8-32D-316			336.50				
			-	9103EZHD-33-8-643E/716			459.20				
-	9103EZHD-33-8-BLK				392.50						
33"	10"	Brass	605	9103EZHD-33-0-US3						379.00	
			606	9103EZHD-33-0-US4			379.00				
			612	9103EZHD-33-0-US10			437.20				
			613	9103EZHD-33-0-US10B			437.20				
			625	9103EZHD-33-0-US26			391.70				
		626	9103EZHD-33-0-US26D			391.70					
		316 Stainless	619	9103EZHD-33-0-US15			390.70				
			629-316	9103EZHD-33-0-32-316			473.00				
			630-316	9103EZHD-33-0-32D-316			346.60				
			-	9103EZHD-33-0-643E/716			437.20				
-	9103EZHD-33-0-BLK				379.00						
33"	12"	Brass	605	9103EZHD-33-2-US3						387.10	
			606	9103EZHD-33-2-US4			387.10				
			612	9103EZHD-33-2-US10			449.80				
			613	9103EZHD-33-2-US10B			449.80				
			625	9103EZHD-33-2-US26			399.60				
		626	9103EZHD-33-2-US26D			399.60					
		316 Stainless	619	9103EZHD-33-2-US15			449.80				
			629-316	9103EZHD-33-2-32-316			483.30				
			630-316	9103EZHD-33-2-32D-316			356.60				
			-	9103EZHD-33-2-643E/716			449.80				
-	9103EZHD-33-2-BLK				387.10						

HINGES
 CONTINUOUS HINGES
 PIVOTS
 Numerical 1-059
 Numerical 59-437
 Numerical 438-1021
 Numerical 1152-8190
 Numerical 8200-9266

Lead time exception: ** Products are stocked and will typically ship within 3 days

Bold pricing indicates item is in stock and available for **Fast Track** and **ProXpress**

HINGES
 CONTINUOUS HINGES
 PIVOTS
 Numerical 1-059
 Numerical 59-437
 Numerical 438-1021
 Numerical 1152-8190
 Numerical 8200-9266

MODEL	PUSH CTC	PULL CTC	SUBSTRATE	FINISH	MODEL NUMBER	DESCRIPTION	WEIGHT	ORDER QTY	BOX QTY	LIST PRICE			
9145EZHD Push / Pull Combo 1" Round (8145EZHD Pull + 9100HD Push) <i>Custom Sizing Available in 1" increments</i> <i>Fractional increments available as Engineered Specials</i> See page 68 for pricing <i>Antimicrobial Coating US26D-AM or US32D-AM available.</i> See page 68 for optional mounting types and pricing.	28"	8"	Brass	605	9145EZHD-28-8-USB3					\$426.60			
				606	9145EZHD-28-8-US4			426.60					
				612	9145EZHD-28-8-US10			494.60					
				613	9145EZHD-28-8-US10B			494.60					
				625	9145EZHD-28-8-US26			494.60					
			626	9145EZHD-28-8-US26D			443.40						
			619	9145EZHD-28-8-US15			443.40						
			629-316	9145EZHD-28-8-32-316			418.90						
			630-316	9145EZHD-28-8-32D-316			364.40						
			-	9145EZHD-28-8-643E/716			494.60						
			-	9145EZHD-28-8-BLK			426.60						
			28"	10"	Brass	605	9145EZHD-28-0-US3						439.50
						606	9145EZHD-28-0-US4			439.50			
						612	9145EZHD-28-0-US10			503.60			
						613	9145EZHD-28-0-US10B			503.60			
						625	9145EZHD-28-0-US26			503.60			
					626	9145EZHD-28-0-US26D			456.70				
					619	9145EZHD-28-0-US15			456.70				
					629-316	9145EZHD-28-0-32-316			429.30				
					630-316	9145EZHD-28-0-32D-316			374.80				
	-	9145EZHD-28-0-643E/716					503.60						
	-	9145EZHD-28-0-BLK					439.50						
	28"	12"			Brass	605	9145EZHD-28-2-US3						448.60
						606	9145EZHD-28-2-US4			448.60			
						612	9145EZHD-28-2-US10			516.80			
						613	9145EZHD-28-2-US10B			516.80			
						625	9145EZHD-28-2-US26			516.80			
					626	9145EZHD-28-2-US26D			470.20				
					619	9145EZHD-28-2-US15			470.20				
					629-316	9145EZHD-28-2-32-316			439.80				
					630-316	9145EZHD-28-2-32D-316			385.20				
			-	9145EZHD-28-2-643E/716			516.80						
			-	9145EZHD-28-2-BLK			448.60						
			28"	18"	Brass	605	9145EZHD-28-18-US3						505.60
						606	9145EZHD-28-18-US4			505.60			
						612	9145EZHD-28-18-US10			578.10			
						613	9145EZHD-28-18-US10B			578.10			
						625	9145EZHD-28-18-US26			578.10			
					626	9145EZHD-28-18-US26D			526.90				
					619	9145EZHD-28-18-US15			526.90				
					629-316	9145EZHD-28-18-32-316			499.20				
					630-316	9145EZHD-28-18-32D-316			444.90				
	-	9145EZHD-28-18-643E/716					578.10						
	-	9145EZHD-28-18-BLK					505.60						
	33"	8"			Brass	605	9145EZHD-33-8-US3						426.60
						606	9145EZHD-33-8-US4			426.60			
						612	9145EZHD-33-8-US10			494.60			
						613	9145EZHD-33-8-US10B			494.60			
						625	9145EZHD-33-8-US26			494.60			
					626	9145EZHD-33-8-US26D			443.40				
					619	9145EZHD-33-8-US15			443.40				
					629-316	9145EZHD-33-8-32-316			502.60				
					630-316	9145EZHD-33-8-32D-316			364.40				
			-	9145EZHD-33-8-643E/716			494.60						
			-	9145EZHD-33-8-BLK			426.60						
			33"	10"	Brass	605	9145EZHD-33-0-US3						439.50
						606	9145EZHD-33-0-US4			439.50			
						612	9145EZHD-33-0-US10			503.60			
						613	9145EZHD-33-0-US10B			503.60			
						625	9145EZHD-33-0-US26			503.60			
					626	9145EZHD-33-0-US26D			456.70				
					619	9145EZHD-33-0-US15			456.70				
					629-316	9145EZHD-33-0-32-316			512.90				
					630-316	9145EZHD-33-0-32D-316			374.80				
	-	9145EZHD-33-0-643E/716					503.60						
	-	9145EZHD-33-0-BLK					439.50						
	33"	12"			Brass	605	9145EZHD-33-2-US3						448.60
						606	9145EZHD-33-2-US4			448.60			
						612	9145EZHD-33-2-US10			516.80			
						613	9145EZHD-33-2-US10B			516.80			
						625	9145EZHD-33-2-US26			516.80			
					626	9145EZHD-33-2-US26D			470.20				
					619	9145EZHD-33-2-US15			470.20				
					629-316	9145EZHD-33-2-32-316			523.40				
					630-316	9145EZHD-33-2-32D-316			385.20				
			-	9145EZHD-33-2-643E/716			516.80						
			-	9145EZHD-33-2-BLK			448.60						
			33"	18"	Brass	605	9145EZHD-33-18-US3						505.60
						606	9145EZHD-33-18-US4			505.60			
						612	9145EZHD-33-18-US10			578.10			
						613	9145EZHD-33-18-US10B			578.10			
						625	9145EZHD-33-18-US26			578.10			
					626	9145EZHD-33-18-US26D			526.90				
					619	9145EZHD-33-18-US15			526.90				
					629-316	9145EZHD-33-18-32-316			582.70				
					630-316	9145EZHD-33-18-32D-316			444.90				
	-	9145EZHD-33-18-643E/716					578.10						
	-	9145EZHD-33-18-BLK					505.60						

Lead time exception: ** Products are stocked and will typically ship within 3 days

Bold pricing indicates item is in stock and available for **Fast Track** and **ProXpress**

MODEL	PUSH CTC	PULL CTC	SUBSTRATE	FINISH	MODEL NUMBER	DESCRIPTION	WEIGHT	ORDER QTY	BOX QTY	LIST PRICE	
9190HD Push / Pull Combo 1" Round (8190HD Pull + 9100HD PUSH) Custom Sizing Available in 1" increments. Fractional increments available as Engineered Specials. See page 68 for pricing Antimicrobial Coating US26D-AM or US32D-AM available. See page 68 for optional mounting types and pricing.	28"	8"	Brass	605	9190HD-28-8-US3					\$399.60	
				606	9190HD-28-8-US4			399.60			
				612	9190HD-28-8-US10			466.50			
				613	9190HD-28-8-US10B			466.50			
				625	9190HD-28-8-US26			459.00			
			626	9190HD-28-8-US26D			416.40				
			Stainless	619	9190HD-28-8-US15			416.40			
				629	9190HD-28-8-US32			337.80			
				630	9190HD-28-8-US32D			292.00			
				-	9190HD-28-8-643E/716			466.50			
	-	9190HD-28-8-BLK				399.60					
	28"	10"	Brass	605	9190HD-28-0-US3						412.20
				606	9190HD-28-0-US4			412.20			
				612	9190HD-28-0-US10			474.60			
				613	9190HD-28-0-US10B			474.60			
				625	9190HD-28-0-US26			467.60			
			626	9190HD-28-0-US26D			428.90				
			Stainless	619	9190HD-28-0-US15			428.90			
				629	9190HD-28-0-US32			345.80			
				630	9190HD-28-0-US32D			300.40			
				-	9190HD-28-0-643E/716			474.60			
	-	9190HD-28-0-BLK				412.20					
	28"	12"	Brass	605	9190HD-28-2-US3						420.80
				606	9190HD-28-2-US4			420.80			
				612	9190HD-28-2-US10			487.40			
				613	9190HD-28-2-US10B			487.40			
				625	9190HD-28-2-US26			479.90			
			626	9190HD-28-2-US26D			441.60				
			Stainless	619	9190HD-28-2-US15			441.60			
				629	9190HD-28-2-US32			427.00			
				630	9190HD-28-2-US32D			308.40			
				-	9190HD-28-2-643E/716			487.40			
	-	9190HD-28-2-BLK				420.80					
	28"	18"	Brass	605	9190HD-28-18-US3						467.60
				606	9190HD-28-18-US4			467.60			
				612	9190HD-28-18-US10			538.30			
				613	9190HD-28-18-US10B			538.30			
				625	9190HD-28-18-US26			538.30			
			626	9190HD-28-18-US26D			488.20				
			Stainless	619	9190HD-28-18-US15			488.20			
				629	9190HD-28-18-US32			394.70			
				630	9190HD-28-18-US32D			348.80			
				-	9190HD-28-18-643E/716			538.30			
	-	9190HD-28-18-BLK				467.60					
	33"	8"	Brass	605	9190HD-33-8-US3						399.60
				606	9190HD-33-8-US4			399.60			
				612	9190HD-33-8-US10			466.50			
				613	9190HD-33-8-US10B			466.50			
				625	9190HD-33-8-US26			459.00			
			626	9190HD-33-8-US26D			416.40				
			Stainless	619	9190HD-33-8-US15			416.40			
				629	9190HD-33-8-US32			337.80			
				630	9190HD-33-8-US32D			292.00			
				-	9190HD-33-8-643E/716			467.60			
	-	9190HD-33-8-BLK				399.60					
	33"	10"	Brass	605	9190HD-33-0-US3						412.20
				606	9190HD-33-0-US4			412.20			
				612	9190HD-33-0-US10			474.60			
				613	9190HD-33-0-US10B			474.60			
				625	9190HD-33-0-US26			467.60			
			626	9190HD-33-0-US26D			428.90				
			Stainless	619	9190HD-33-0-US15			428.90			
				629	9190HD-33-0-US32			345.80			
				630	9190HD-33-0-US32D**			300.40			
				-	9190HD-33-0-643E/716			474.60			
	-	9190HD-33-0-BLK				412.20					
	33"	12"	Brass	605	9190HD-33-2-US3						420.80
				606	9190HD-33-2-US4			420.80			
				612	9190HD-33-2-US10			487.40			
				613	9190HD-33-2-US10B			487.40			
				625	9190HD-33-2-US26			479.90			
			626	9190HD-33-2-US26D			441.60				
			Stainless	619	9190HD-33-2-US15			441.60			
				629	9190HD-33-2-US32			427.00			
				630	9190HD-33-2-US32D			308.40			
				-	9190HD-33-2-643E/716			487.40			
	-	9190HD-33-2-BLK				420.80					
	33"	18"	Brass	605	9190HD-33-18-US3						467.60
				606	9190HD-33-18-US4			467.60			
				612	9190HD-33-18-US10			538.30			
				613	9190HD-33-18-US10B			538.30			
				625	9190HD-33-18-US26			538.30			
			626	9190HD-33-18-US26D			488.20				
			Stainless	619	9190HD-33-18-US15			488.20			
				629	9190HD-33-18-US32			467.30			
				630	9190HD-33-18-US32D			348.80			
				-	9190HD-33-18-643E/716			538.30			
	-	9190HD-33-18-BLK				467.60					

Lead time exception: ** Products are stocked and will typically ship within 3 days

Bold pricing indicates item is in stock and available for **Fast Track** and **ProXpress**

HINGES
 CONTINUOUS HINGES
 PIVOTS
 Numerical 1-059
 Numerical 59-437
 Numerical 438-1021
 Numerical 1152-8190
 Numerical 8200-9266

HINGES
 CONTINUOUS HINGES
 PIVOTS
 Numerical 1-059
 Numerical 59-437
 Numerical 438-1021
 Numerical 1152-8190
 Numerical 8200-9266

MODEL	PUSH CTC	PULL CTC	SUBSTRATE	FINISH	MODEL NUMBER	DESCRIPTION	WEIGHT	ORDER QTY	BOX QTY	LIST PRICE	
9190EZHD Push / Pull Combo 1" Round (8190EZHD Pull + 9100HD Push) <i>Custom Sizing Available in 1" increments</i> <i>Fractional increments available as Engineered Specials</i> See page 68 for pricing <i>Antimicrobial Coating US26D-AM or US32D-AM available.</i> See page 68 for optional mounting types and pricing.	28"	8"	Brass	605	9190EZHD-28-8-USB3					\$426.60	
				606	9190EZHD-28-8-US4				426.60		
				612	9190EZHD-28-8-US10				494.60		
				613	9190EZHD-28-8-US10B				494.60		
				625	9190EZHD-28-8-US26				494.60		
				626	9190EZHD-28-8-US26D				443.40		
		316 Stainless	619	9190EZHD-28-8-US15				443.40			
			629-316	9190EZHD-28-8-32-316				418.90			
			630-316	9190EZHD-28-8-32D-316				364.40			
			-	9190EZHD-28-8-643E/716				494.60			
			-	9190EZHD-28-8-BLK				426.60			
			-								
	28"	10"	Brass	605	9190EZHD-28-0-US3						439.50
				606	9190EZHD-28-0-US4				439.50		
				612	9190EZHD-28-0-US10				503.60		
				613	9190EZHD-28-0-US10B				503.60		
				625	9190EZHD-28-0-US26				503.60		
				626	9190EZHD-28-0-US26D				456.70		
		316 Stainless	619	9190EZHD-28-0-US15				456.70			
			629-316	9190EZHD-28-0-32-316				429.30			
			630-316	9190EZHD-28-0-32D-316				374.80			
			-	9190EZHD-28-0-643E/716				503.60			
			-	9190EZHD-28-0-BLK				439.50			
			-								
	28"	12"	Brass	605	9190EZHD-28-2-US3						448.60
				606	9190EZHD-28-2-US4				448.60		
				612	9190EZHD-28-2-US10				516.80		
				613	9190EZHD-28-2-US10B				516.80		
				625	9190EZHD-28-2-US26				516.80		
				626	9190EZHD-28-2-US26D				470.20		
		316 Stainless	619	9190EZHD-28-2-US15				470.20			
			629-316	9190EZHD-28-2-32-316				439.80			
			630-316	9190EZHD-28-2-32D-316				385.20			
			-	9190EZHD-28-2-643E/716				516.80			
			-	9190EZHD-28-2-BLK				448.60			
			-								
	28"	18"	Brass	605	9190EZHD-28-18-US3						505.60
				606	9190EZHD-28-18-US4				505.60		
				612	9190EZHD-28-18-US10				578.10		
				613	9190EZHD-28-18-US10B				578.10		
				625	9190EZHD-28-18-US26				578.10		
				626	9190EZHD-28-18-US26D				526.90		
		316 Stainless	619	9190EZHD-28-18-US15				526.90			
			629-316	9190EZHD-28-18-32-316				499.20			
			630-316	9190EZHD-28-18-32D-316				444.90			
			-	9190EZHD-28-18-643E/716				578.10			
			-	9190EZHD-28-18-BLK				505.60			
			-								
33"	8"	Brass	605	9190EZHD-33-8-US3						426.60	
			606	9190EZHD-33-8-US4				426.60			
			612	9190EZHD-33-8-US10				494.60			
			613	9190EZHD-33-8-US10B				494.60			
			625	9190EZHD-33-8-US26				494.60			
			626	9190EZHD-33-8-US26D				443.40			
	316 Stainless	619	9190EZHD-33-8-US15				443.40				
		629-316	9190EZHD-33-8-32-316				502.60				
		630-316	9190EZHD-33-8-32D-316				364.40				
		-	9190EZHD-33-8-643E/716				494.60				
		-	9190EZHD-33-8-BLK				426.60				
		-									
33"	10"	Brass	605	9190EZHD-33-0-US3						439.50	
			606	9190EZHD-33-0-US4				439.50			
			612	9190EZHD-33-0-US10				503.60			
			613	9190EZHD-33-0-US10B				503.60			
			625	9190EZHD-33-0-US26				503.60			
			626	9190EZHD-33-0-US26D				456.70			
	316 Stainless	619	9190EZHD-33-0-US15				456.70				
		629-316	9190EZHD-33-0-32-316				512.90				
		630-316	9190EZHD-33-0-32D-316				374.80				
		-	9190EZHD-33-0-643E/716				503.60				
		-	9190EZHD-33-0-BLK				439.50				
		-									
33"	12"	Brass	605	9190EZHD-33-2-US3						448.60	
			606	9190EZHD-33-2-US4				448.60			
			612	9190EZHD-33-2-US10				516.80			
			613	9190EZHD-33-2-US10B				516.80			
			625	9190EZHD-33-2-US26				516.80			
			626	9190EZHD-33-2-US26D				470.20			
	316 Stainless	619	9190EZHD-33-2-US15				470.20				
		629-316	9190EZHD-33-2-32-316				523.40				
		630-316	9190EZHD-33-2-32D-316				385.20				
		-	9190EZHD-33-2-643E/716				516.80				
		-	9190EZHD-33-2-BLK				448.60				
		-									
33"	18"	Brass	605	9190EZHD-33-18-US3						505.60	
			606	9190EZHD-33-18-US4				505.60			
			612	9190EZHD-33-18-US10				578.10			
			613	9190EZHD-33-18-US10B				578.10			
			625	9190EZHD-33-18-US26				578.10			
			626	9190EZHD-33-18-US26D				526.90			
	316 Stainless	619	9190EZHD-33-18-US15				526.90				
		629-316	9190EZHD-33-18-32-316				582.70				
		630-316	9190EZHD-33-18-32D-316				444.90				
		-	9190EZHD-33-18-643E/716				578.10				
		-	9190EZHD-33-18-BLK				505.60				
		-									

Lead time exception: ** Products are stocked and will typically ship within 3 days

Bold pricing indicates item is in stock and available for **Fast Track** and **ProXpress**

Offset Long Pulls

	Length	Pull CTC	FINISH	List
9264 (Round Tip) or 9264F (Flat Tip)	12"	8"	605	\$426.60
	12"	8"	606	426.60
	12"	8"	613	439.10
	12"	8"	619	439.10
	12"	8"	629-316	432.80
	12"	8"	630-316	363.80
	12"	8"	643E/716	439.10
	12"	8"	BLK	426.60
9264 (Round Tip) or 9264F (Flat Tip)	18"	12"	605	489.30
	18"	12"	606	489.30
	18"	12"	613	502.00
	18"	12"	619	502.00
	18"	12"	629-316	483.10
	18"	12"	630-316	395.20
	18"	12"	643E/716	502.00
	18"	12"	BLK	489.30
9264 (Round Tip) or 9264F (Flat Tip)	24"	18"	605	552.00
	24"	18"	606	552.00
	24"	18"	613	564.60
	24"	18"	619	564.60
	24"	18"	629-316	533.30
	24"	18"	630-316	426.60
	24"	18"	643E/716	564.60
	24"	18"	BLK	552.00
9264 (Round Tip) or 9264F (Flat Tip)	36"	20"	605	827.10
	36"	20"	606	862.20
	36"	20"	613	910.50
	36"	20"	619	910.50
	36"	20"	629-316	837.10
	36"	20"	630-316**	563.50
	36"	20"	643E/716	910.50
	36"	20"	BLK	862.20
9264 (Round Tip) or 9264F (Flat Tip)	72"	56"	605	1,013.20
	72"	56"	606	1,013.20
	72"	56"	613	1,053.50
	72"	56"	619	1,053.50
	72"	56"	629-316	983.60
	72"	56"	630-316	673.40
	72"	56"	BLK	1,013.20
	72"	56"	BLK	1,013.20

Straight Long Pulls

9266 (Round Tip) or 9266F (Flat Tip)	12"	8"	605	\$338.80
	12"	8"	606	338.80
	12"	8"	613	345.10
	12"	8"	619	345.10
	12"	8"	629-316	338.80
	12"	8"	630-316	269.80
	12"	8"	643E/716	345.10
	12"	8"	BLK	338.80
9266 (Round Tip) or 9266F (Flat Tip)	18"	12"	605	401.40
	18"	12"	606	401.40
	18"	12"	613	407.70
	18"	12"	619	407.70
	18"	12"	629-316	389.10
	18"	12"	630-316	301.10
	18"	12"	643E/716	407.70
	18"	12"	BLK	401.40
9266 (Round Tip) or 9266F (Flat Tip)	24"	18"	605	464.30
	24"	18"	606	464.30
	24"	18"	613	470.40
	24"	18"	619	470.40
	24"	18"	629-316	439.10
	24"	18"	630-316	332.50
	24"	18"	643E/716	470.40
	24"	18"	BLK	464.30
9266 (Round Tip) or 9266F (Flat Tip)	36"	20"	605	644.00
	36"	20"	606	671.30
	36"	20"	613	688.30
	36"	20"	619	688.30
	36"	20"	629-316	651.90
	36"	20"	630-316	471.20
	36"	20"	643E/716*	688.30
	36"	20"	BLK	671.30
9266 (Round Tip) or 9266F (Flat Tip)	72"	56"	605	821.30
	72"	56"	606	821.30
	72"	56"	613	830.80
	72"	56"	619	830.80
	72"	56"	629-316	798.50
	72"	56"	630-316	589.40
	72"	56"	BLK	821.30
	72"	56"	BLK	821.30

See Next Page for Long Pull Options Pricing

See page 68 for optional mounting types and pricing.

* Max length for 643E/716 finish is 36"

- Custom Lengths, Center to Center, and Finishes
- Additional Mounting Brackets

Lead time exception: ** Products are stocked and will typically ship within 3 days

Bold pricing indicates item is in stock and available for Fast Track and ProXpress

Long Pull Options

Custom Lengths*		FINISH	List
· Order in 1" increments. List price for 1" increments between 12" and 72" use next larger size list price.			
· Greater than 72", use list price add per inch charge per finish.		605, 606, BLK	\$67.00
		613, 619,	76.00
		629-316	79.00
		630-316	15.00
· If fractional lengths are required, use the following list adder. For pulls less than 72" long, use the next higher standard length price plus the list adder for pricing. For pulls greater than 72", use the 72" price plus the price add per inch plus the fractional list adder.			181.00
Custom Center to Center*		FINISH	List
· If not specified, standard center to center length for pulls 36" or longer, center to center length is 16" less than total pull length. Center to Center length must be specified for lengths less than 36"			
· For non standard center to center lengths or locations on standard length pulls, use the following list adder. Consult factory if the center to center length is less than half the total pull length. If the fractional custom length adder is being applied, then the custom center to center will not be applied			92.00
Custom Finishes*		FINISH	List
Custom painting & Antimicrobial Coating <i>US32D-AM only</i>	Contact customer service for size availability, pricing, and color approval. Additional lead time up to 6 weeks may be needed.		
*Return Policy - requires prior approval, consult factory			
Optional Mounting Hardware		FINISH	List
MB	Additional Mounting Bracket, list price adder per bracket <i>Unless specified, additional mounting brackets are centered on pull. Mounting Bracket and list adder are required for pulls over 96".</i>		162.00
See page 68 for optional mounting types and pricing.			

HINGES
 CONTINUOUS HINGES
 PIVOTS
 Numerical 1-059
 Numerical 59-437
 Numerical 438-1021
 Numerical 1152-8190
 Numerical 8200-9266

Lead time exception: ** Products are stocked and will typically ship within 3 days

Bold pricing indicates item is in stock and available for **Fast Track** and **ProXpress**

IVES ARCHITECTURAL HARDWARE - Parts Price List

Description	Finish	Part No.	List Price Each
3.5X3.5 HINGES Item 3CB1, 3PB1, 5BB1, 5PB1			
3.5X3.5 Hinge Mtg Pkg	600(USP)	HGPART.1171	\$3.60
3.5X3.5 Hinge Mtg Pkg	630(US32D), 629(US32), 646/619(US15)	HGPART.1170	3.60
3.5X3.5 Hinge Mtg Pkg	632/605(US3), 633/606(US4)	HGPART.1173	3.60
3.5X3.5 Hinge Mtg Pkg	639(US10), 612 (US10)	HGPART.1174	3.60
3.5X3.5 Hinge Mtg Pkg	640/613(US10B), 641/614(US10A), 643/616(US11)	HGPART.1175	3.60
3.5X3.5 Hinge Mtg Pkg	651/625(US26), 652/626(US26D)	HGPART.1176	3.60
3.5X3.5 Hinge Mtg Pkg	BLK	HGPART.1172	3.60
HINGES Item 3CB1, 3PB1, 3SP1*, 5BB1, 5BB1SC, 5PB1 (4X4 Hinges or Larger)			
Hinge Mtg Pkg	605(US3), 632(US3), 633(US4)	HGPART.1001	3.60
Hinge Mtg Pkg	639(US10)	HGPART.1002	3.60
Hinge Mtg Pkg	600(USP),630(US32D),651(US26)	HGPART.1003	3.60
Hinge Mtg Pkg	643(US11)	HGPART.1004	3.60
Hinge MS Security Mtg Pkg	-	HGPART.1005	25.10
Hinge MS Mtg Screws Pkg of 100 - Steel	600(USP)	HGPART.1026	6.70
Hinge MS Mtg Screws Pkg of 100 - Brass	605(US3)	HGPART.1008	13.30
Hinge MS Mtg Screws Pkg of 100 - Steel	632(US3)	HGPART.1018	6.70
Hinge MS Mtg Screws Pkg of 100 - Brass	606(US4)	HGPART.1032	13.30
Hinge MS Mtg Screws Pkg of 100 - Steel	633(US4)	HGPART.1035	6.70
Hinge MS Mtg Screws Pkg of 100 - Brass	612(US10)	HGPART.1010	13.30
Hinge MS Mtg Screws Pkg of 100 - Steel	639(US10)	HGPART.1019	6.70
Hinge MS Mtg Screws Pkg of 100 - Brass	613(US10B)	HGPART.1011	13.30
Hinge MS Mtg Screws Pkg of 100 - Steel	640(US10B)	HGPART.1020	6.70
Hinge MS Mtg Screws Pkg of 100 - Steel	641(US10A)	HGPART.1028	6.70
Hinge MS Mtg Screws Pkg of 100 - Steel	643(US11)	HGPART.1029	6.70
Hinge MS Mtg Screws Pkg of 100 - Brass	619(US15)	HGPART.1009	13.30
Hinge MS Mtg Screws Pkg of 100 - Steel	646(US15)	HGPART.1021	6.70
Hinge MS Mtg Screws Pkg of 100 - Brass	625(US26)	HGPART.1033	13.30
Hinge MS Mtg Screws Pkg of 100 - Steel	651(US26)	HGPART.1036	6.70
Hinge MS Mtg Screws Pkg of 100 - Brass	626(US26D)	HGPART.1034	13.30
Hinge MS Mtg Screws Pkg of 100 - Steel	652(US26D)	HGPART.1037	6.70
Hinge MS Mtg Screws Pkg of 100 - Stainless Steel	630(US32D)	HGPART.1016	13.30
Hinge WS Mtg Screws Pkg of 100 - Steel	600(USP)	HGPART.1027	6.70
Hinge WS Mtg Screws Pkg of 100 - Brass	605(US3)	HGPART.1012	26.40
Hinge WS Mtg Screws Pkg of 100 - Steel	632(US3)	HGPART.1022	6.70
Hinge WS Mtg Screws Pkg of 100 - Brass	606(US4)	HGPART.1038	28.20
Hinge WS Mtg Screws Pkg of 100 - Steel	633(US4)	HGPART.1041	6.70
Hinge WS Mtg Screws Pkg of 100 - Brass	612(US10)	HGPART.1014	28.20
Hinge WS Mtg Screws Pkg of 100 - Steel	639(US10)	HGPART.1023	6.70
Hinge WS Mtg Screws Pkg of 100 - Brass	613(US10B)	HGPART.1015	28.20
Hinge WS Mtg Screws Pkg of 100 - Steel	640(US10B)	HGPART.1024	6.70
Hinge WS Mtg Screws Pkg of 100 - Steel	641(US10A)	HGPART.1030	6.70
Hinge WS Mtg Screws Pkg of 100 - Steel	643(US11)	HGPART.1031	6.70
Hinge WS Mtg Screws Pkg of 100 - Brass	619(US15)	HGPART.1013	26.40
Hinge WS Mtg Screws Pkg of 100 - Steel	646(US15)	HGPART.1025	6.70
Hinge WS Mtg Screws Pkg of 100 - Brass	625(US26)	HGPART.1039	26.40
Hinge WS Mtg Screws Pkg of 100 - Steel	651(US26)	HGPART.1042	6.70
Hinge WS Mtg Screws Pkg of 100 - Brass	626(US26D)	HGPART.1040	26.40
Hinge WS Mtg Screws Pkg of 100 - Steel	652(US26D)	HGPART.1043	6.70
Hinge WS Mtg Screws Pkg of 100 - Stainless Steel	630(US32D)	HGPART.1017	26.40
CONTINUOUS HINGES - GEARED			
Chinge Geared Tek Scr Pkg Us28 (Pkg of 48)	US28	HGPART.1070	24.30
Chinge Geared Tek Scr Pkg 313AN, 315AN (Pkg of 48)	313AN, 315AN	HGPART.1071	24.30
Chinge Geared Tek/Wd Scr Pkg Us28 (24 Tek/24 Wood)	US28	HGPART.1102	24.30

Contact Ives Customer Service for pricing on additional sizes and finishes
 *Tension Adjustment Locking Pins- 2.5mm x 8mm pin supplied by others.

Bold pricing indicates item is in stock and available for **Fast Track** and **ProXpress**

IVES ARCHITECTURAL HARDWARE - Parts Price List

Description	Finish	Part No.	List Price Each
CONTINUOUS HINGES - GEARED (Continued)			
Chinge Geared Tek/Wd Scr Pkg 313AN, 315AN (24 Tek/24 Wood)	313AN, 315AN	HGPART.1103	\$23.40
Chinge Geared Wd Scr Pkg Us28 (Pkg of 48)	US28	HGPART.1068	23.40
Chinge Geared Wd Scr Pkg 313AN, 315AN (Pkg of 48)	313AN, 315AN	HGPART.1069	23.40
Chinge Geared Hm Sec Scr Pkg Us32D (Pkg of 24)	US32D	HGPART.1104	41.50
Chinge Geared Wd Sec Scr Pkg Us32D (Pkg of 24)	US32D	HGPART.1105	41.50
112HD TWP Panel Service Kit	US28	840737-28	293.00
112HD TWP Panel Service Kit	313AN, 315AN	840737-42	293.00
224HD TWP Panel Service Kit	US28	840738-28	293.00
224HD TWP Panel Service Kit	313AN, 315AN	840738-42	293.00
XY TWP CON Panel Service Kit	US28	HGPART.1159	345.00
XY TWP CON Panel Service Kit	313AN, 315AN	HGPART.1160	345.00
112HD/224HD 6' Power Cable Kit	US28	840738-00	414.00
CONTINUOUS HINGES - Pin & Barrel			
Chinge Pin & Barrel #10 X 1/2 Tek Screw SELF DRILL (Pkg of 54)	US32D	HGPART.1044	27.10
Chinge Pin & Barrel #10 X 1 Flat Head Wood Screw (Pkg of 27)	US32D	HGPART.1046	13.40
Chinge Pin & Barrel #10 X 3/4" Tek Screw (Pkg of 27)	US32D	HGPART.1050	23.00
Chinge Pin & Barrel 120" 1/2" TEK screw pkg		HGPART.1044	27.10
Chinge Pin & Barrel 120" Full Surface screw pkg (Pan Head TEK)		HGPART.1045	21.60
Chinge Pin & Barrel 120" wood screw pkg		HGPART.1046	13.30
Chinge Pin & Barrel 120" Full Surface cover clip pkg		HGPART.1047	45.40
Chinge Pin & Barrel 120" Adjustment stud (with machine screws) pkg of 27		HGPART.1048	106.60
Chinge Pin & Barrel 120" Full Surface sexbolt pkg		HGPART.1049	106.60
Chinge Pin & Barrel 120" 3/4" TEK screw pkg		HGPART.1050	22.70
Chinge Pin & Barrel Replacment ETW Module	US32D	HGPART.1108	363.70
Chinge Pin & Barrel 83" Full Surface screw cover	US32D	HGPART.1109	93.80
Chinge Pin & Barrel 85" Full Surface screw cover	US32D	HGPART.1110	93.80
Chinge Pin & Barrel 95" Full Surface screw cover	US32D	HGPART.1111	107.80
Chinge Pin & Barrel 120" Full Surface screw cover	US32D	HGPART.1112	125.00
Chinge Pin & Barrel 120" hollow metal security screw pkg (Torx screws)		HGPART.1113	191.20
Chinge Pin & Barrel 120" hollow metal machine screw pkg		HGPART.1114	45.40
Chinge Pin & Barrel 120" wood door security screw pkg (wood Torx screws)		HGPART.1124	191.30
700CSTWP Panel Service Kit	US32D	HGPART.1153	987.00
PIVOTS 7212/15/22/26/27 & 7215F/26F/27F Top Pivot			
7212/15/22/26/27 Top Bearing Leaf	US3	PVPART.1001	153.50
7212/15/22/26/27 Top Bearing Leaf	US4	PVPART.1002	153.50
7212/15/22/26/27 Top Bearing Leaf	US10	PVPART.1003	153.50
7212/15/22/26/27 Top Bearing Leaf	US10B	PVPART.1004	153.50
7212/15/22/26/27 Top Bearing Leaf	US26	PVPART.1005	153.50
7212/15/22/26/27 Top Bearing Leaf	US26D	PVPART.1006	131.60
7212/15/22/26/27 Top Bearing Leaf	SP4	PVPART.1007	94.50
7212/15/22/26/27 Top Bearing Leaf	SPI0	PVPART.1008	94.50
7212/15/22/26/27 Top Bearing Leaf	SP28	PVPART.1009	94.50
7212/15/22/26/27 Top Bearing Leaf	SP313	PVPART.1010	94.50
7212/15/22/26/27 Top Bearing Leaf	SPBLK	PVPART.1011	94.50
7212/15/22/26/27 Top Pin Leaf	US3	PVPART.1012	153.50
7212/15/22/26/27 Top Pin Leaf	US4	PVPART.1013	153.50
7212/15/22/26/27 Top Pin Leaf	US10	PVPART.1014	153.50
7212/15/22/26/27 Top Pin Leaf	US10B	PVPART.1015	153.50
7212/15/22/26/27 Top Pin Leaf	US26	PVPART.1016	153.50

Contact Ives Customer Service for pricing on additional sizes and finishes

Bold pricing indicates item is in stock and available for **Fast Track** and **ProXpress**

IVES ARCHITECTURAL HARDWARE - Parts Price List

Description	Finish	Part No.	List Price Each
PIVOTS 7212/15/22/26/27 & 7215F/26F/27F Top Pivot (Continued)			
7212/15/22/26/27 Top Pin Leaf	US26D	PVPART.1017	\$131.60
7212/15/22/26/27 Top Pin Leaf	SP4	PVPART.1018	94.50
7212/15/22/26/27 Top Pin Leaf	SP10	PVPART.1019	94.50
7212/15/22/26/27 Top Pin Leaf	SP28	PVPART.1020	94.50
7212/15/22/26/27 Top Pin Leaf	SP313	PVPART.1021	94.50
7212/15/22/26/27 Top Pin Leaf	SPBLK	PVPART.1022	94.50
7215F/26F/27F Top Bearing Leaf	US3	PVPART.1227	272.00
7215F/26F/27F Top Bearing Leaf	US10	PVPART.1228	272.00
7215F/26F/27F Top Bearing Leaf	US32	PVPART.1229	272.00
7215F/26F/27F Top Bearing Leaf	US32D	PVPART.1230	235.00
7215F/26F/27F Top Bearing Leaf	SP4	PVPART.1231	197.80
7215F/26F/27F Top Bearing Leaf	SP10	PVPART.1232	197.80
7215F/26F/27F Top Bearing Leaf	SP28	PVPART.1233	197.80
7215F/26F/27F Top Bearing Leaf	SP313	PVPART.1234	197.80
7215F/26F/27F Top Bearing Leaf	SPBLK	PVPART.1235	197.80
7215F/26F/27F Top Pin Leaf	US3	PVPART.1236	272.00
7215F/26F/27F Top Pin Leaf	US10	PVPART.1237	272.00
7215F/26F/27F Top Pin Leaf	US32	PVPART.1238	272.00
7215F/26F/27F Top Pin Leaf	US32D	PVPART.1239	235.00
7215F/26F/27F Top Pin Leaf	SP4	PVPART.1240	197.80
7215F/26F/27F Top Pin Leaf	SP10	PVPART.1241	197.80
7215F/26F/27F Top Pin Leaf	SP28	PVPART.1242	197.80
7215F/26F/27F Top Pin Leaf	SP313	PVPART.1243	197.80
7215F/26F/27F Top Pin Leaf	SPBLK	PVPART.1244	197.80
7212/12V/15/22/26/27/44/45 Top Mounting Pkg	US3, US4, SP4	PVPART.1023	16.30
7212/12V/15/22/26/27/44/45 Top Mounting Pkg	US10, SP10	PVPART.1024	16.30
7212/12V/15/22/26/27/44/45 Top Mounting Pkg	US10B, SP313	PVPART.1025	16.30
7212/12V/15/22/26/27/44/45 Top Mounting Pkg	US26, US26D, SP28, US32, US32D	PVPART.1026	16.30
7212/12V/15/22/26/27/44/45 Top Mounting Pkg	SPBLK	PVPART.1027	16.30
7212/12V/15/22/26/27/44/45 Top Security Mtg Pkg	-	PVPART.1028	29.40
7212/12V/15/22/26/27/44/45 Top Wood Mtg Pkg	US3, US4, SP4	PVPART.1821	14.90
7212/12V/15/22/26/27/44/45 Top Wood Mtg Pkg	US10, SP10	PVPART.1822	14.90
7212/12V/15/22/26/27/44/45 Top Wood Mtg Pkg	US10B, SP313	PVPART.1823	14.90
7212/12V/15/22/26/27/44/45 Top Wood Mtg Pkg	US26, US26D, SP28, US32, US32D	PVPART.1824	14.90
7212/12V/15/22/26/27/44/45 Top Wood Mtg Pkg	SPBLK	PVPART.1825	14.90
7212/15/22/26/27/30/37/44/45 Top Pivot Pin	-	PVPART.1029	7.50
Pivot Set Screw (Pkg of 10)	-	PVPART.1030	6.00
Pivot Bushing	-	PVPART.1870	3.60
7212/15/22/26/27/30/37/44/45 Cap Screw	US3	PVPART.1032	23.60
7212/15/22/26/27/30/37/44/45 Cap Screw	US4	PVPART.1033	23.60
7212/15/22/26/27/30/37/44/45 Cap Screw	US10	PVPART.1034	23.60
7212/15/22/26/27/30/37/44/45 Cap Screw	US10B	PVPART.1035	23.60
7212/15/22/26/27/30/37/44/45 Cap Screw	US26, US32	PVPART.1036	23.60
7212/15/22/26/27/30/37/44/45 Cap Screw	US26D, US32D	PVPART.1037	23.60
7212/15/22/26/27/30/37/44/45 Cap Screw	SP4	PVPART.1038	23.60
7212/15/22/26/27/30/37/44/45 Cap Screw	SP10	PVPART.1039	23.60
7212/15/22/26/27/30/37/44/45 Cap Screw	SP28	PVPART.1040	23.60
7212/15/22/26/27/30/37/44/45 Cap Screw	SP313	PVPART.1041	23.60
7212/15/22/26/27/30/37/44/45 Cap Screw	SPBLK	PVPART.1042	23.60
7212V Top Pivot			
7212V Top Door Leaf - RH	US3	PVPART.1144	159.70
7212V Top Door Leaf - RH	US4	PVPART.1145	159.70
7212V Top Door Leaf - RH	US10	PVPART.1146	159.70

Contact Ives Customer Service for pricing on additional sizes and finishes

Bold pricing indicates item is in stock and available for **Fast Track** and **ProXpress**

IVES ARCHITECTURAL HARDWARE - Parts Price List

Description	Finish	Part No.	List Price Each
7212V Top Pivot (Continued)			
7212V Top Door Leaf - RH	US10B	PVPART.1147	\$159.70
7212V Top Door Leaf - RH	US26	PVPART.1148	159.70
7212V Top Door Leaf - RH	US26D	PVPART.1149	137.20
7212V Top Door Leaf - RH	SP4	PVPART.1150	104.70
7212V Top Door Leaf - RH	SP10	PVPART.1151	104.70
7212V Top Door Leaf - RH	SP28	PVPART.1152	104.70
7212V Top Door Leaf - RH	SP313	PVPART.1153	104.70
7212V Top Door Leaf - RH	SPBLK	PVPART.1154	104.70
7212V Top Jamb Leaf - RH	US3	PVPART.1155	159.70
7212V Top Jamb Leaf - RH	US4	PVPART.1156	159.70
7212V Top Jamb Leaf - RH	US10	PVPART.1157	159.70
7212V Top Jamb Leaf - RH	US10B	PVPART.1158	159.70
7212V Top Jamb Leaf - RH	US26	PVPART.1159	159.70
7212V Top Jamb Leaf - RH	US26D	PVPART.1160	137.20
7212V Top Jamb Leaf - RH	SP4	PVPART.1161	104.70
7212V Top Jamb Leaf - RH	SP10	PVPART.1162	104.70
7212V Top Jamb Leaf - RH	SP28	PVPART.1163	104.70
7212V Top Jamb Leaf - RH	SP313	PVPART.1164	104.70
7212V Top Jamb Leaf - RH	SPBLK	PVPART.1165	104.70
7212V Top Door Leaf - LH	US3	PVPART.1166	159.70
7212V Top Door Leaf - LH	US4	PVPART.1167	159.70
7212V Top Door Leaf - LH	US10	PVPART.1168	159.70
7212V Top Door Leaf - LH	US10B	PVPART.1169	159.70
7212V Top Door Leaf - LH	US26	PVPART.1170	159.70
7212V Top Door Leaf - LH	US26D	PVPART.1171	137.20
7212V Top Door Leaf - LH	SP4	PVPART.1172	104.70
7212V Top Door Leaf - LH	SP10	PVPART.1173	104.70
7212V Top Door Leaf - LH	SP28	PVPART.1174	104.70
7212V Top Door Leaf - LH	SP313	PVPART.1175	104.70
7212V Top Door Leaf - LH	SPBLK	PVPART.1176	104.70
7212V Top Jamb Leaf - LH	US3	PVPART.1177	159.70
7212V Top Jamb Leaf - LH	US4	PVPART.1178	159.70
7212V Top Jamb Leaf - LH	US10	PVPART.1179	159.70
7212V Top Jamb Leaf - LH	US10B	PVPART.1180	159.70
7212V Top Jamb Leaf - LH	US26	PVPART.1181	159.70
7212V Top Jamb Leaf - LH	US26D	PVPART.1182	137.20
7212V Top Jamb Leaf - LH	SP4	PVPART.1183	104.70
7212V Top Jamb Leaf - LH	SP10	PVPART.1184	104.70
7212V Top Jamb Leaf - LH	SP28	PVPART.1185	104.70
7212V Top Jamb Leaf - LH	SP313	PVPART.1186	104.70
7212V Top Jamb Leaf - LH	SPBLK	PVPART.1187	104.70
7212/12V/15/26/27/44/45 Top Mtg Pkg	US3, US4, SP4	PVPART.1023	16.30
7212/12V/15/26/27/44/45 Top Mtg Pkg	US10, SP10	PVPART.1024	16.30
7212/12V/15/26/27/44/45 Top Mtg Pkg	US10B, SP313	PVPART.1025	16.30
7212/12V/15/26/27/44/45 Top Mtg Pkg	US26, US26D, SP28	PVPART.1026	16.30
7212/12V/15/26/27/44/45 Top Mtg Pkg	SPBLK	PVPART.1027	16.30
7212/12V/15/26/27/44/45 Top Wood Mtg Pkg	US3, US4, SP4	PVPART.1821	14.90
7212/12V/15/26/27/44/45 Top Wood Mtg Pkg	US10, SP10	PVPART.1822	14.90
7212/12V/15/26/27/44/45 Top Wood Mtg Pkg	US10B, SP313	PVPART.1823	14.90
7212/12V/15/26/27/44/45 Top Wood Mtg Pkg	US26, US26D, SP28	PVPART.1824	14.90
7212/12V/15/26/27/44/45 Top Wood Mtg Pkg	SPBLK	PVPART.1825	14.90
7212/12V/15/26/27/44/45 Top Security Mtg Pkg	-	PVPART.1028	29.40
Pivot Set Screw (Pkg of 10)	-	PVPART.1030	6.00

Contact Ives Customer Service for pricing on additional sizes and finishes

Bold pricing indicates item is in stock and available for **Fast Track** and **ProXpress**

IVES ARCHITECTURAL HARDWARE - Parts Price List

Description	Finish	Part No.	List Price Each
7212V Top Pivot (Continued)			
7212/12V/22 Pivot Bearing	-	PVPART.1031	6.00
7212/12V/22 Pivot Bearing Pin	-	PVPART.1093	6.00
7212V Pivot Pin Cap	US3	PVPART.1194	16.30
7212V Pivot Pin Cap	US4	PVPART.1195	16.30
7212V Pivot Pin Cap	US10	PVPART.1196	16.30
7212V Pivot Pin Cap	US10B	PVPART.1197	16.30
7212V Pivot Pin Cap	US26	PVPART.1198	16.30
7212V Pivot Pin Cap	US26D	PVPART.1199	16.30
7212V Pivot Pin Cap	SP4	PVPART.1200	16.30
7212V Pivot Pin Cap	SP10	PVPART.1201	16.30
7212V Pivot Pin Cap	SP28	PVPART.1202	16.30
7212V Pivot Pin Cap	SP313	PVPART.1203	16.30
7212V Pivot Pin Cap	SPBLK	PVPART.1204	16.30
7230F/37F Top Pivot			
7230F/37F Top Bearing Leaf	US3	PVPART.1517	252.50
7230F/37F Top Bearing Leaf	US10	PVPART.1518	252.50
7230F/37F Top Bearing Leaf	US32	PVPART.1519	252.50
7230F/37F Top Bearing Leaf	US32D	PVPART.1520	235.00
7230F/37F Top Bearing Leaf	SP4	PVPART.1521	208.20
7230F/37F Top Bearing Leaf	SP10	PVPART.1522	208.20
7230F/37F Top Bearing Leaf	SP28	PVPART.1523	208.20
7230F/37F Top Bearing Leaf	SP313	PVPART.1524	208.20
7230F/37F Top Bearing Leaf	SPBLK	PVPART.1525	208.20
7230F/37F Top Pin Leaf	US3	PVPART.1526	252.50
7230F/37F Top Pin Leaf	US10	PVPART.1527	252.50
7230F/37F Top Pin Leaf	US32	PVPART.1528	252.50
7230F/37F Top Pin Leaf	US32D	PVPART.1529	235.00
7230F/37F Top Pin Leaf	SP4	PVPART.1530	208.20
7230F/37F Top Pin Leaf	SP10	PVPART.1531	208.20
7230F/37F Top Pin Leaf	SP28	PVPART.1532	208.20
7230F/37F Top Pin Leaf	SP313	PVPART.1533	208.20
7230F/37F Top Pin Leaf	SPBLK	PVPART.1534	208.20
7230F/37F Top Mounting Pkg	US3, SP4	PVPART.1535	23.60
7230F/37F Top Mounting Pkg	US10, SP10	PVPART.1536	23.60
7230F/37F Top Mounting Pkg	US32, US32D, SP28	PVPART.1537	23.60
7230F/37F Top Mounting Pkg	SP313	PVPART.1542	23.60
7230F/37F Top Mounting Pkg	SPBLK	PVPART.1543	23.60
7230F/37F Top Security Mounting Pkg	-	PVPART.1544	43.00
7230F/37F Top Wood Mtg Pkg	US3, SP4	PVPART.1841	18.50
7230F/37F Top Wood Mtg Pkg	US10, SP10	PVPART.1842	18.50
7230F/37F Top Wood Mtg Pkg	US32, US32D, SP28	PVPART.1843	18.50
7230F/37F Top Wood Mtg Pkg	SP313	PVPART.1844	18.50
7230F/37F Top Wood Mtg Pkg	SPBLK	PVPART.1845	18.50
7212/15/22/26/27/30/37/44/45 Top Pivot Pin	-	PVPART.1029	7.50
Pivot Set Screw (Pkg of 10)	-	PVPART.1030	6.00
Pivot Bushing	-	PVPART.1870	3.60
7212/15/22/26/27/30/37/44/45 Cap Screw	US3	PVPART.1032	23.60
7212/15/22/26/27/30/37/44/45 Cap Screw	US10	PVPART.1034	23.60
7212/15/22/26/27/30/37/44/45 Cap Screw	US32	PVPART.1036	23.60
7212/15/22/26/27/30/37/44/45 Cap Screw	US32D	PVPART.1037	23.60
7212/15/22/26/27/30/37/44/45 Cap Screw	SP4	PVPART.1038	23.60
7212/15/22/26/27/30/37/44/45 Cap Screw	SP10	PVPART.1039	23.60

Contact Ives Customer Service for pricing on additional sizes and finishes

Bold pricing indicates item is in stock and available for **Fast Track** and **ProXpress**

IVES ARCHITECTURAL HARDWARE - Parts Price List

Parts

Description	Finish	Part No.	List Price Each
7230F/37F Top Pivot (Continued)			
7212/15/22/26/27/30/37/44/45 Cap Screw	SP28	PVPART.1040	\$23.60
7212/15/22/26/27/30/37/44/45 Cap Screw	SP313	PVPART.1041	23.60
7212/15/22/26/27/30/37/44/45 Cap Screw	SPBLK	PVPART.1042	23.60
7244F/45F Top Pivot			
7244F/45F Top Bearing Leaf	US3	PVPART.1615	274.50
7244F/45F Top Bearing Leaf	US10	PVPART.1616	274.50
7244F/45F Top Bearing Leaf	US32	PVPART.1617	274.50
7244F/45F Top Bearing Leaf	US32D	PVPART.1618	263.10
7244F/45F Top Bearing Leaf	SP4	PVPART.1619	239.20
7244F/45F Top Bearing Leaf	SP10	PVPART.1620	239.20
7244F/45F Top Bearing Leaf	SP28	PVPART.1621	239.20
7244F/45F Top Bearing Leaf	SP313	PVPART.1622	239.20
7244F/45F Top Bearing Leaf	SPBLK	PVPART.1623	239.20
7244F/45F Top Pin Leaf	US3	PVPART.1624	274.50
7244F/45F Top Pin Leaf	US10	PVPART.1625	274.50
7244F/45F Top Pin Leaf	US32	PVPART.1626	274.50
7244F/45F Top Pin Leaf	US32D	PVPART.1627	263.10
7244F/45F Top Pin Leaf	SP4	PVPART.1628	239.20
7244F/45F Top Pin Leaf	SP10	PVPART.1629	239.20
7244F/45F Top Pin Leaf	SP28	PVPART.1630	239.20
7244F/45F Top Pin Leaf	SP313	PVPART.1631	239.20
7244F/45F Top Pin Leaf	SPBLK	PVPART.1632	239.20
7212/12V/15/26/27/44/45 Top Mounting Pkg	US3, SP4	PVPART.1023	16.30
7212/12V/15/26/27/44/45 Top Mounting Pkg	US10, SP10	PVPART.1024	16.30
7212/12V/15/26/27/44/45 Top Mounting Pkg	US32, US32D, SP28	PVPART.1026	16.30
7212/12V/15/26/27/44/45 Top Mounting Pkg	SP313	PVPART.1025	16.30
7212/12V/15/26/27/44/45 Top Mounting Pkg	SPBLK	PVPART.1027	16.30
7212/12V/15/26/27/44/45 Top Security Mtg Pkg	-	PVPART.1028	29.40
7212/12V/15/26/27/44/45 Top Wood Mtg Pkg	US3, SP4	PVPART.1821	14.90
7212/12V/15/26/27/44/45 Top Wood Mtg Pkg	US10, SP10	PVPART.1822	14.90
7212/12V/15/26/27/44/45 Top Wood Mtg Pkg	US32, US32D, SP28	PVPART.1824	14.90
7212/12V/15/26/27/44/45 Top Wood Mtg Pkg	SP313	PVPART.1823	14.90
7212/12V/15/26/27/44/45 Top Wood Mtg Pkg	SPBLK	PVPART.1825	14.90
7212/15/22/26/27/30/37/44/45 Top Pivot Pin	-	PVPART.1029	7.50
Pivot Set Screw (Pkg of 10)	-	PVPART.1030	6.00
Pivot Bushing	-	PVPART.1870	3.60
7212/15/22/26/27/30/37/44/45 Cover Cap Screw	US3	PVPART.1032	23.60
7212/15/22/26/27/30/37/44/45 Cover Cap Screw	US10	PVPART.1034	23.60
7212/15/22/26/27/30/37/44/45 Cover Cap Screw	US32	PVPART.1036	23.60
7212/15/22/26/27/30/37/44/45 Cover Cap Screw	US32D	PVPART.1037	23.60
7212/15/22/26/27/30/37/44/45 Cover Cap Screw	SP4	PVPART.1038	23.60
7212/15/22/26/27/30/37/44/45 Cover Cap Screw	SP10	PVPART.1039	23.60
7212/15/22/26/27/30/37/44/45 Cover Cap Screw	SP28	PVPART.1040	23.60
7212/15/22/26/27/30/37/44/45 Cover Cap Screw	SP313	PVPART.1041	23.60
7212/15/22/26/27/30/37/44/45 Cover Cap Screw	SPBLK	PVPART.1042	23.60
7253/55/55J/56 Top Pivot			
7253/55/55J/56 Top Door Leaf	-	PVPART.1705	208.20
7253/55/55J/56 Top Frame Leaf	US3	PVPART.1706	208.20
7253/55/55J/56 Top Frame Leaf	US4	PVPART.1707	208.20
7253/55/55J/56 Top Frame Leaf	US10	PVPART.1708	208.20
7253/55/55J/56 Top Frame Leaf	US10B	PVPART.1709	208.20
7253/55/55J/56 Top Frame Leaf	US26	PVPART.1710	208.20
7253/55/55J/56 Top Frame Leaf	US26D	PVPART.1711	208.20

Contact Ives Customer Service for pricing on additional sizes and finishes

Bold pricing indicates item is in stock and available for **Fast Track** and **ProXpress**

IVES ARCHITECTURAL HARDWARE - Parts Price List

Description	Finish	Part No.	List Price Each
7253/55/55J/56 Top Pivot(Continued)			
7253/55/55J/56 Top Frame Leaf	SP4	PVPART.1712	\$180.20
7253/55/55J/56 Top Frame Leaf	SP10	PVPART.1713	180.20
7253/55/55J/56 Top Frame Leaf	SP28	PVPART.1714	180.20
7253/55/55J/56 Top Frame Leaf	SP313	PVPART.1715	180.20
7253/55/55J/56 Top Frame Leaf	SPBLK	PVPART.1716	180.20
7253/55/55J/56 Top Finish Plate Pkg	US3	PVPART.1717	86.90
7253/55/55J/56 Top Finish Plate Pkg	US4	PVPART.1718	86.90
7253/55/55J/56 Top Finish Plate Pkg	US10	PVPART.1719	86.90
7253/55/55J/56 Top Finish Plate Pkg	US10B	PVPART.1720	86.90
7253/55/55J/56 Top Finish Plate Pkg	US26	PVPART.1721	86.90
7253/55/55J/56 Top Finish Plate Pkg	US26D	PVPART.1722	86.90
7253/55/55J/56 Top Finish Plate Pkg	SP4	PVPART.1723	54.60
7253/55/55J/56 Top Finish Plate Pkg	SP10	PVPART.1724	54.60
7253/55/55J/56 Top Finish Plate Pkg	SP28	PVPART.1725	54.60
7253/55/55J/56 Top Finish Plate Pkg	SP313	PVPART.1726	54.60
7253/55/55J/56 Top Finish Plate Pkg	SPBLK	PVPART.1727	54.60
7227/37/45/56/59 Finish Plate Screw (Pkg of 10)	-	PVPART.1335	2.20
7253/55/55J/56/59 Top Mounting Pkg	US3, US4, SP4	PVPART.1729	16.30
7253/55/55J/56/59 Top Mounting Pkg	US10, SP10	PVPART.1730	16.30
7253/55/55J/56/59 Top Mounting Pkg	US10B, SP313	PVPART.1731	16.30
7253/55/55J/56/59 Top Mounting Pkg	US26, US26D, SP28	PVPART.1732	16.30
7253/55/55J/56/59 Top Mounting Pkg	SPBLK	PVPART.1733	16.30
7253/55/55J/56/59 Top Security Mtg Pkg	-	PVPART.1734	22.20
7253/55/55J/56/59 Top Wood Mtg Pkg	US3, US4, SP4	PVPART.1859	10.40
7253/55/55J/56/59 Top Wood Mtg Pkg	US10, SP10	PVPART.1860	10.40
7253/55/55J/56/59 Top Wood Mtg Pkg	US10B, SP313	PVPART.1861	10.40
7253/55/55J/56/59 Top Wood Mtg Pkg	US26, US26D, SP28	PVPART.1862	10.40
7253/55/55J/56/59 Top Wood Mtg Pkg	SPBLK	PVPART.1863	10.40
7259 Top Pivot			
7259 Top Door Leaf	-	PVPART.1788	208.20
7259 Top Frame Leaf	US3	PVPART.1789	208.20
7259 Top Frame Leaf	US4	PVPART.1790	208.20
7259 Top Frame Leaf	US10	PVPART.1791	208.20
7259 Top Frame Leaf	US10B	PVPART.1792	208.20
7259 Top Frame Leaf	US26	PVPART.1793	208.20
7259 Top Frame Leaf	US26D	PVPART.1794	208.20
7259 Top Frame Leaf	SP4	PVPART.1795	180.20
7259 Top Frame Leaf	SP10	PVPART.1796	180.20
7259 Top Frame Leaf	SP28	PVPART.1797	180.20
7259 Top Frame Leaf	SP313	PVPART.1798	180.20
7259 Top Frame Leaf	SPBLK	PVPART.1799	180.20
7259 Top Finish Plate Pkg	US3	PVPART.1800	86.90
7259 Top Finish Plate Pkg	US4	PVPART.1801	86.90
7259 Top Finish Plate Pkg	US10	PVPART.1802	86.90
7259 Top Finish Plate Pkg	US10B	PVPART.1803	86.90
7259 Top Finish Plate Pkg	US26	PVPART.1804	86.90
7259 Top Finish Plate Pkg	US26D	PVPART.1805	86.90
7259 Top Finish Plate Pkg	SP4	PVPART.1806	54.60
7259 Top Finish Plate Pkg	SP10	PVPART.1807	54.60
7259 Top Finish Plate Pkg	SP28	PVPART.1808	54.60
7259 Top Finish Plate Pkg	SP313	PVPART.1809	54.60
7259 Top Finish Plate Pkg	SPBLK	PVPART.1810	54.60
7227/37/45/56/59 Finish Plate Screw (Pkg of 10)	-	PVPART.1335	2.20

Contact Ives Customer Service for pricing on additional sizes and finishes

Bold pricing indicates item is in stock and available for **Fast Track** and **ProXpress**

IVES ARCHITECTURAL HARDWARE - Parts Price List

Description	Finish	Part No.	List Price Each
7259 Top Pivot (Continued)			
7253/55/55J/56/59 Top Mounting Pkg	US3, US4, SP4	PVPART.1729	\$16.30
7253/55/55J/56/59 Top Mounting Pkg	US10, SP10	PVPART.1730	16.30
7253/55/55J/56/59 Top Mounting Pkg	US10B, SP313	PVPART.1731	16.30
7253/55/55J/56/59 Top Mounting Pkg	US26, US26D, SP28	PVPART.1732	16.30
7253/55/55J/56/59 Top Mounting Pkg	SPBLK	PVPART.1733	16.30
7253/55/55J/56/59 Top Security Mtg Pkg	-	PVPART.1734	22.20
7253/55/55J/56/59 Top Wood Mtg Pkg	US3, US4, SP4	PVPART.1859	10.40
7253/55/55J/56/59 Top Wood Mtg Pkg	US10, SP10	PVPART.1860	10.40
7253/55/55J/56/59 Top Wood Mtg Pkg	US10B, SP313	PVPART.1861	10.40
7253/55/55J/56/59 Top Wood Mtg Pkg	US26, US26D, SP28	PVPART.1862	10.40
7253/55/55J/56/59 Top Wood Mtg Pkg	SPBLK	PVPART.1863	10.40
7212/12V/22 Intermediate Pivot			
7212/12V/22 Int Door Leaf - RH	US3	PVPART.1094	175.90
7212/12V/22 Int Door Leaf - RH	US4	PVPART.1095	175.90
7212/12V/22 Int Door Leaf - RH	US10	PVPART.1096	175.90
7212/12V/22 Int Door Leaf - RH	US10B	PVPART.1097	175.90
7212/12V/22 Int Door Leaf - RH	US26	PVPART.1098	175.90
7212/12V/22 Int Door Leaf - RH	US26D	PVPART.1099	153.50
7212/12V/22 Int Door Leaf - RH	SP4	PVPART.1100	122.60
7212/12V/22 Int Door Leaf - RH	SP10	PVPART.1101	122.60
7212/12V/22 Int Door Leaf - RH	SP28	PVPART.1102	122.60
7212/12V/22 Int Door Leaf - RH	SP313	PVPART.1103	122.60
7212/12V/22 Int Door Leaf - RH	SPBLK	PVPART.1104	122.60
7212/12V/22 Int Jamb Leaf - RH	US3	PVPART.1105	175.90
7212/12V/22 Int Jamb Leaf - RH	US4	PVPART.1106	175.90
7212/12V/22 Int Jamb Leaf - RH	US10	PVPART.1107	175.90
7212/12V/22 Int Jamb Leaf - RH	US10B	PVPART.1108	175.90
7212/12V/22 Int Jamb Leaf - RH	US26	PVPART.1109	175.90
7212/12V/22 Int Jamb Leaf - RH	US26D	PVPART.1110	153.50
7212/12V/22 Int Jamb Leaf - RH	SP4	PVPART.1111	122.60
7212/12V/22 Int Jamb Leaf - RH	SP10	PVPART.1112	122.60
7212/12V/22 Int Jamb Leaf - RH	SP28	PVPART.1113	122.60
7212/12V/22 Int Jamb Leaf - RH	SP313	PVPART.1114	122.60
7212/12V/22 Int Jamb Leaf - RH	SPBLK	PVPART.1115	122.60
7212/12V/22 Int Door Leaf - LH	US3	PVPART.1116	175.90
7212/12V/22 Int Door Leaf - LH	US4	PVPART.1117	175.90
7212/12V/22 Int Door Leaf - LH	US10	PVPART.1118	175.90
7212/12V/22 Int Door Leaf - LH	US10B	PVPART.1119	175.90
7212/12V/22 Int Door Leaf - LH	US26	PVPART.1120	175.90
7212/12V/22 Int Door Leaf - LH	US26D	PVPART.1121	153.50
7212/12V/22 Int Door Leaf - LH	SP4	PVPART.1122	122.60
7212/12V/22 Int Door Leaf - LH	SP10	PVPART.1123	122.60
7212/12V/22 Int Door Leaf - LH	SP28	PVPART.1124	122.60
7212/12V/22 Int Door Leaf - LH	SP313	PVPART.1125	122.60
7212/12V/22 Int Door Leaf - LH	SPBLK	PVPART.1126	122.60
7212/12V/22 Int Jamb Leaf - LH	US3	PVPART.1127	175.90
7212/12V/22 Int Jamb Leaf - LH	US4	PVPART.1128	175.90
7212/12V/22 Int Jamb Leaf - LH	US10	PVPART.1129	175.90
7212/12V/22 Int Jamb Leaf - LH	US10B	PVPART.1130	175.90
7212/12V/22 Int Jamb Leaf - LH	US26	PVPART.1131	175.90
7212/12V/22 Int Jamb Leaf - LH	US26D	PVPART.1132	153.50
7212/12V/22 Int Jamb Leaf - LH	SP4	PVPART.1133	122.60
7212/12V/22 Int Jamb Leaf - LH	SP10	PVPART.1134	122.60

Contact Ives Customer Service for pricing on additional sizes and finishes

Bold pricing indicates item is in stock and available for **Fast Track** and **ProXpress**

IVES ARCHITECTURAL HARDWARE - Parts Price List

Description	Finish	Part No.	List Price Each
7212/12V/22 Intermediate Pivot (Continued)			
7212/12V/22 Int Jamb Leaf - LH	SP28	PVPART.1135	\$122.60
7212/12V/22 Int Jamb Leaf - LH	SP313	PVPART.1136	122.60
7212/12V/22 Int Jamb Leaf - LH	SPBLK	PVPART.1137	122.60
7212/12V/22 Int Mounting Pkg	US3, US4, SP4	PVPART.1138	14.90
7212/12V/22 Int Mounting Pkg	US10, SP10	PVPART.1139	14.90
7212/12V/22 Int Mounting Pkg	US10B, SP313	PVPART.1140	14.90
7212/12V/22 Int Mounting Pkg	US26, US26D, SP28	PVPART.1141	14.90
7212/12V/22 Int Mounting Pkg	SPBLK	PVPART.1142	14.90
7212/12V/22 Int Wood Mtg Pkg	US3, US4, SP4	PVPART.1831	10.90
7212/12V/22 Int Wood Mtg Pkg	US10, SP10	PVPART.1832	10.90
7212/12V/22 Int Wood Mtg Pkg	US10B, SP313	PVPART.1833	10.90
7212/12V/22 Int Wood Mtg Pkg	US26, US26D, SP28	PVPART.1834	10.90
7212/12V/22 Int Wood Mtg Pkg	SPBLK	PVPART.1835	10.90
7212/12V/22 Int Security Mtg Pkg	-	PVPART.1143	22.20
Pivot Set Screw (Pkg of 10)	-	PVPART.1030	6.00
7212/12V/22 Pivot Bearing	-	PVPART.1031	6.00
7212/12V/22 Pivot Bearing Pin	-	PVPART.1093	6.00
7215/26/27 & 7215F/26F/27F Intermediate Pivot			
7215/26/27 Int Door Leaf - RH	US3	PVPART.1354	159.70
7215/26/27 Int Door Leaf - RH	US4	PVPART.1355	159.70
7215/26/27 Int Door Leaf - RH	US10	PVPART.1356	159.70
7215/26/27 Int Door Leaf - RH	US10B	PVPART.1357	159.70
7215/26/27 Int Door Leaf - RH	US26	PVPART.1358	159.70
7215/26/27 Int Door Leaf - RH	US26D	PVPART.1359	143.10
7215/26/27 Int Door Leaf - RH	SP4	PVPART.1360	131.60
7215/26/27 Int Door Leaf - RH	SP10	PVPART.1361	131.60
7215/26/27 Int Door Leaf - RH	SP28	PVPART.1362	131.60
7215/26/27 Int Door Leaf - RH	SP313	PVPART.1363	131.60
7215/26/27 Int Door Leaf - RH	SPBLK	PVPART.1364	131.60
7215/26/27 Int Jamb Leaf - RH	US3	PVPART.1365	159.70
7215/26/27 Int Jamb Leaf - RH	US4	PVPART.1366	159.70
7215/26/27 Int Jamb Leaf - RH	US10	PVPART.1367	159.70
7215/26/27 Int Jamb Leaf - RH	US10B	PVPART.1368	159.70
7215/26/27 Int Jamb Leaf - RH	US26	PVPART.1369	159.70
7215/26/27 Int Jamb Leaf - RH	US26D	PVPART.1370	143.10
7215/26/27 Int Jamb Leaf - RH	SP4	PVPART.1371	131.60
7215/26/27 Int Jamb Leaf - RH	SP10	PVPART.1372	131.60
7215/26/27 Int Jamb Leaf - RH	SP28	PVPART.1373	131.60
7215/26/27 Int Jamb Leaf - RH	SP313	PVPART.1374	131.60
7215/26/27 Int Jamb Leaf - RH	SPBLK	PVPART.1375	131.60
7215/26/27 Int Door Leaf - LH	US3	PVPART.1376	159.70
7215/26/27 Int Door Leaf - LH	US4	PVPART.1377	159.70
7215/26/27 Int Door Leaf - LH	US10	PVPART.1378	159.70
7215/26/27 Int Door Leaf - LH	US10B	PVPART.1379	159.70
7215/26/27 Int Door Leaf - LH	US26	PVPART.1380	159.70
7215/26/27 Int Door Leaf - LH	US26D	PVPART.1381	143.10
7215/26/27 Int Door Leaf - LH	SP4	PVPART.1382	131.60
7215/26/27 Int Door Leaf - LH	SP10	PVPART.1383	131.60
7215/26/27 Int Door Leaf - LH	SP28	PVPART.1384	131.60
7215/26/27 Int Door Leaf - LH	SP313	PVPART.1385	131.60
7215/26/27 Int Door Leaf - LH	SPBLK	PVPART.1386	131.60
7215/26/27 Int Jamb Leaf - LH	US3	PVPART.1387	159.70
7215/26/27 Int Jamb Leaf - LH	US4	PVPART.1388	159.70

Contact Ives Customer Service for pricing on additional sizes and finishes

Bold pricing indicates item is in stock and available for **Fast Track** and **ProXpress**

IVES ARCHITECTURAL HARDWARE - Parts Price List

Description	Finish	Part No.	List Price Each
7215/26/27 & 7215F/26F/27F Intermediate Pivot (Continued)			
7215/26/27 Int Jamb Leaf - LH	US10	PVPART.1389	\$159.70
7215/26/27 Int Jamb Leaf - LH	US10B	PVPART.1390	159.70
7215/26/27 Int Jamb Leaf - LH	US26	PVPART.1391	159.70
7215/26/27 Int Jamb Leaf - LH	US26D	PVPART.1392	143.10
7215/26/27 Int Jamb Leaf - LH	SP4	PVPART.1393	131.60
7215/26/27 Int Jamb Leaf - LH	SP10	PVPART.1394	131.60
7215/26/27 Int Jamb Leaf - LH	SP28	PVPART.1395	131.60
7215/26/27 Int Jamb Leaf - LH	SP313	PVPART.1396	131.60
7215/26/27 Int Jamb Leaf - LH	SPBLK	PVPART.1397	131.60
7215F/26F/27F Int Door Leaf - RH	US3	PVPART.1398	252.50
7215F/26F/27F Int Door Leaf - RH	US10	PVPART.1399	252.50
7215F/26F/27F Int Door Leaf - RH	US32	PVPART.1400	252.50
7215F/26F/27F Int Door Leaf - RH	US32D	PVPART.1401	240.70
7215F/26F/27F Int Door Leaf - RH	SP4	PVPART.1402	203.50
7215F/26F/27F Int Door Leaf - RH	SP10	PVPART.1403	203.50
7215F/26F/27F Int Door Leaf - RH	SP28	PVPART.1404	203.50
7215F/26F/27F Int Door Leaf - RH	SP313	PVPART.1405	203.50
7215F/26F/27F Int Door Leaf - RH	SPBLK	PVPART.1406	203.50
7215F/26F/27F Int Jamb Leaf - RH	US3	PVPART.1407	252.50
7215F/26F/27F Int Jamb Leaf - RH	US10	PVPART.1408	252.50
7215F/26F/27F Int Jamb Leaf - RH	US32	PVPART.1409	252.50
7215F/26F/27F Int Jamb Leaf - RH	US32D	PVPART.1410	240.70
7215F/26F/27F Int Jamb Leaf - RH	SP4	PVPART.1411	203.50
7215F/26F/27F Int Jamb Leaf - RH	SP10	PVPART.1412	203.50
7215F/26F/27F Int Jamb Leaf - RH	SP28	PVPART.1413	203.50
7215F/26F/27F Int Jamb Leaf - RH	SP313	PVPART.1414	203.50
7215F/26F/27F Int Jamb Leaf - RH	SPBLK	PVPART.1415	203.50
7215F/26F/27F Int Door Leaf - LH	US3	PVPART.1416	252.50
7215F/26F/27F Int Door Leaf - LH	US10	PVPART.1417	252.50
7215F/26F/27F Int Door Leaf - LH	US32	PVPART.1418	252.50
7215F/26F/27F Int Door Leaf - LH	US32D	PVPART.1419	240.70
7215F/26F/27F Int Door Leaf - LH	SP4	PVPART.1420	203.50
7215F/26F/27F Int Door Leaf - LH	SP10	PVPART.1421	203.50
7215F/26F/27F Int Door Leaf - LH	SP28	PVPART.1422	203.50
7215F/26F/27F Int Door Leaf - LH	SP313	PVPART.1423	203.50
7215F/26F/27F Int Door Leaf - LH	SPBLK	PVPART.1424	203.50
7215F/26F/27F Int Jamb Leaf - LH	US3	PVPART.1425	252.50
7215F/26F/27F Int Jamb Leaf - LH	US10	PVPART.1426	252.50
7215F/26F/27F Int Jamb Leaf - LH	US32	PVPART.1427	252.50
7215F/26F/27F Int Jamb Leaf - LH	US32D	PVPART.1428	240.70
7215F/26F/27F Int Jamb Leaf - LH	SP4	PVPART.1429	203.50
7215F/26F/27F Int Jamb Leaf - LH	SP10	PVPART.1430	203.50
7215F/26F/27F Int Jamb Leaf - LH	SP28	PVPART.1431	203.50
7215F/26F/27F Int Jamb Leaf - LH	SP313	PVPART.1432	203.50
7215F/26F/27F Int Jamb Leaf - LH	SPBLK	PVPART.1433	203.50
7215/26/27/30/37/44/45 Int Mounting Pkg	US3, US4, SP4	PVPART.1434	14.90
7215/26/27/30/37/44/45 Int Mounting Pkg	US10, SP10	PVPART.1435	14.90
7215/26/27/30/37/44/45 Int Mounting Pkg	US10B, SP313	PVPART.1436	14.90
7215/26/27/30/37/44/45 Int Mounting Pkg	US26, US26D, US32, US32D, SP28	PVPART.1437	14.90
7215/26/27/30/37/44/45 Int Mounting Pkg	SPBLK	PVPART.1438	14.90
7215/26/27/30/37/44/45 Int Security Mtg Pkg	-	PVPART.1439	35.70
7215/26/27/30/37/44/45 Int Wood Mtg Pkg	US3, US4, SP4	PVPART.1836	16.30

Contact Ives Customer Service for pricing on additional sizes and finishes

Bold pricing indicates item is in stock and available for **Fast Track** and **ProXpress**

IVES ARCHITECTURAL HARDWARE - Parts Price List

Description	Finish	Part No.	List Price Each
7215/26/27 & 7215F/26F/27F Intermediate Pivot (Continued)			
7215/26/27/30/37/44/45 Int Wood Mtg Pkg	US10, SP10	PVPART.1837	\$16.30
7215/26/27/30/37/44/45 Int Wood Mtg Pkg	US10B, SP313	PVPART.1838	16.30
7215/26/27/30/37/44/45 Int Wood Mtg Pkg	US26, US26D, US32, US32D, SP28	PVPART.1839	16.30
7215/26/27/30/37/44/45 Int Wood Mtg Pkg	SPBLK	PVPART.1840	16.30
7212/15/22/26/27/30/37/44/45 Cap Screw	US3	PVPART.1032	23.60
7212/15/22/26/27/30/37/44/45 Cap Screw	US4	PVPART.1033	23.60
7212/15/22/26/27/30/37/44/45 Cap Screw	US10	PVPART.1034	23.60
7212/15/22/26/27/30/37/44/45 Cap Screw	US10B	PVPART.1035	23.60
7212/15/22/26/27/30/37/44/45 Cap Screw	US26, US32	PVPART.1036	23.60
7212/15/22/26/27/30/37/44/45 Cap Screw	US26D, US32D	PVPART.1037	23.60
7212/15/22/26/27/30/37/44/45 Cap Screw	SP4	PVPART.1038	23.60
7212/15/22/26/27/30/37/44/45 Cap Screw	SP10	PVPART.1039	23.60
7212/15/22/26/27/30/37/44/45 Cap Screw	SP28	PVPART.1040	23.60
7212/15/22/26/27/30/37/44/45 Cap Screw	SP313	PVPART.1041	23.60
7212/15/22/26/27/30/37/44/45 Cap Screw	SPBLK	PVPART.1042	23.60
7215/26/27 Pivot Ball	-	PVPART.1349	2.20
Pivot Bushing	-	PVPART.1870	3.60
Pivot Retainer Lock	-	PVPART.1353	8.80
Pivot Washer (Pkg of 10)	-	PVPART.1352	7.50
7215/26/27/30/37/44/45 Int Pivot Bearing Pin	-	PVPART.1847	14.90
7230F/37F Intermediate Pivot			
7230F/37F Int Door Leaf - RH	US3	PVPART.1565	274.50
7230F/37F Int Door Leaf - RH	US10	PVPART.1566	274.50
7230F/37F Int Door Leaf - RH	US32	PVPART.1567	274.50
7230F/37F Int Door Leaf - RH	US32D	PVPART.1568	263.10
7230F/37F Int Door Leaf - RH	SP4	PVPART.1569	225.90
7230F/37F Int Door Leaf - RH	SP10	PVPART.1570	225.90
7230F/37F Int Door Leaf - RH	SP28	PVPART.1571	225.90
7230F/37F Int Door Leaf - RH	SP313	PVPART.1572	225.90
7230F/37F Int Door Leaf - RH	SPBLK	PVPART.1573	225.90
7230F/37F Int Jamb Leaf - RH	US3	PVPART.1574	274.50
7230F/37F Int Jamb Leaf - RH	US10	PVPART.1575	274.50
7230F/37F Int Jamb Leaf - RH	US32	PVPART.1576	274.50
7230F/37F Int Jamb Leaf - RH	US32D	PVPART.1577	263.10
7230F/37F Int Jamb Leaf - RH	SP4	PVPART.1578	225.90
7230F/37F Int Jamb Leaf - RH	SP10	PVPART.1579	225.90
7230F/37F Int Jamb Leaf - RH	SP28	PVPART.1580	225.90
7230F/37F Int Jamb Leaf - RH	SP313	PVPART.1581	225.90
7230F/37F Int Jamb Leaf - RH	SPBLK	PVPART.1582	225.90
7230F/37F Int Door Leaf - LH	US3	PVPART.1583	274.50
7230F/37F Int Door Leaf - LH	US10	PVPART.1584	274.50
7230F/37F Int Door Leaf - LH	US32	PVPART.1585	274.50
7230F/37F Int Door Leaf - LH	US32D	PVPART.1586	263.10
7230F/37F Int Door Leaf - LH	SP4	PVPART.1587	225.90
7230F/37F Int Door Leaf - LH	SP10	PVPART.1588	225.90
7230F/37F Int Door Leaf - LH	SP28	PVPART.1589	225.90
7230F/37F Int Door Leaf - LH	SP313	PVPART.1590	225.90
7230F/37F Int Door Leaf - LH	SPBLK	PVPART.1591	225.90
7230F/37F Int Jamb Leaf - LH	US3	PVPART.1592	274.50
7230F/37F Int Jamb Leaf - LH	US10	PVPART.1593	274.50
7230F/37F Int Jamb Leaf - LH	US32	PVPART.1594	274.50
7230F/37F Int Jamb Leaf - LH	US32D	PVPART.1595	263.10
7230F/37F Int Jamb Leaf - LH	SP4	PVPART.1596	225.90

Contact Ives Customer Service for pricing on additional sizes and finishes

Bold pricing indicates item is in stock and available for **Fast Track** and **ProXpress**

IVES ARCHITECTURAL HARDWARE - Parts Price List

Description	Finish	Part No.	List Price Each
7230F/37F Intermediate Pivot (Continued)			
7230F/37F Int Jamb Leaf - LH	SP10	PVPART.1597	\$225.90
7230F/37F Int Jamb Leaf - LH	SP28	PVPART.1598	225.90
7230F/37F Int Jamb Leaf - LH	SP313	PVPART.1599	225.90
7230F/37F Int Jamb Leaf - LH	SPBLK	PVPART.1600	225.90
7215/26/27/30/37/44/45 Int Mounting Pkg	US3, SP4	PVPART.1434	14.90
7215/26/27/30/37/44/45 Int Mounting Pkg	US10, SP10	PVPART.1435	14.90
7215/26/27/30/37/44/45 Int Mounting Pkg	SP313	PVPART.1436	14.90
7215/26/27/30/37/44/45 Int Mounting Pkg	US32, US32D, SP28	PVPART.1437	14.90
7215/26/27/30/37/44/45 Int Mounting Pkg	SPBLK	PVPART.1438	14.90
7215/26/27/30/37/44/45 Int Security Mtg Pkg	-	PVPART.1439	35.70
7215/26/27/30/37/44/45 Int Wood Mtg Pkg	US3, US4	PVPART.1836	16.30
7215/26/27/30/37/44/45 Int Wood Mtg Pkg	US10, SP10	PVPART.1837	16.30
7215/26/27/30/37/44/45 Int Wood Mtg Pkg	SP313	PVPART.1838	16.30
7215/26/27/30/37/44/45 Int Wood Mtg Pkg	US32, US32D, SP28	PVPART.1839	16.30
7215/26/27/30/37/44/45 Int Wood Mtg Pkg	SPBLK	PVPART.1840	16.30
7212/15/22/26/27/30/37/44/45 Cap Screw	US3	PVPART.1032	23.60
7212/15/22/26/27/30/37/44/45 Cap Screw	US10	PVPART.1034	23.60
7212/15/22/26/27/30/37/44/45 Cap Screw	US32	PVPART.1036	23.60
7212/15/22/26/27/30/37/44/45 Cap Screw	US32D	PVPART.1037	23.60
7212/15/22/26/27/30/37/44/45 Cap Screw	SP4	PVPART.1038	23.60
7212/15/22/26/27/30/37/44/45 Cap Screw	SP10	PVPART.1039	23.60
7212/15/22/26/27/30/37/44/45 Cap Screw	SP28	PVPART.1040	23.60
7212/15/22/26/27/30/37/44/45 Cap Screw	SP313	PVPART.1041	23.60
7212/15/22/26/27/30/37/44/45 Cap Screw	SPBLK	PVPART.1042	23.60
7230/37/44/45 Intermediate Pivot Ball	-	PVPART.1607	2.20
Pivot Bushing	-	PVPART.1870	3.60
Pivot Retainer Lock	-	PVPART.1353	8.80
Pivot Washer (Pkg of 10)	-	PVPART.1352	7.50
7215/26/27/30/37/44/45 Int Pivot Bearing Pin	-	PVPART.1847	14.90
7244F/45F Intermediate Pivot			
7244F/45F Int Door Leaf - RH	US3	PVPART.1655	298.30
7244F/45F Int Door Leaf - RH	US10	PVPART.1656	298.30
7244F/45F Int Door Leaf - RH	US32	PVPART.1657	298.30
7244F/45F Int Door Leaf - RH	US32D	PVPART.1658	280.50
7244F/45F Int Door Leaf - RH	SP4	PVPART.1659	252.50
7244F/45F Int Door Leaf - RH	SP10	PVPART.1660	252.50
7244F/45F Int Door Leaf - RH	SP28	PVPART.1661	252.50
7244F/45F Int Door Leaf - RH	SP313	PVPART.1662	252.50
7244F/45F Int Door Leaf - RH	SPBLK	PVPART.1663	252.50
7244F/45F Int Jamb Leaf - RH	US3	PVPART.1664	298.30
7244F/45F Int Jamb Leaf - RH	US10	PVPART.1665	298.30
7244F/45F Int Jamb Leaf - RH	US32	PVPART.1666	298.30
7244F/45F Int Jamb Leaf - RH	US32D	PVPART.1667	280.50
7244F/45F Int Jamb Leaf - RH	SP4	PVPART.1668	252.50
7244F/45F Int Jamb Leaf - RH	SP10	PVPART.1669	252.50
7244F/45F Int Jamb Leaf - RH	SP28	PVPART.1670	252.50
7244F/45F Int Jamb Leaf - RH	SP313	PVPART.1671	252.50
7244F/45F Int Jamb Leaf - RH	SPBLK	PVPART.1672	252.50
7244F/45F Int Door Leaf - LH	US3	PVPART.1673	298.30
7244F/45F Int Door Leaf - LH	US10	PVPART.1674	298.30
7244F/45F Int Door Leaf - LH	US32	PVPART.1675	298.30
7244F/45F Int Door Leaf - LH	US32D	PVPART.1676	280.50

Contact Ives Customer Service for pricing on additional sizes and finishes

Bold pricing indicates item is in stock and available for **Fast Track** and **ProXpress**

IVES ARCHITECTURAL HARDWARE - Parts Price List

Description	Finish	Part No.	List Price Each
7244F/45F Intermediate Pivot (Continued)			
7244F/45F Int Door Leaf - LH	SP4	PVPART.1677	\$252.50
7244F/45F Int Door Leaf - LH	SP10	PVPART.1678	252.50
7244F/45F Int Door Leaf - LH	SP28	PVPART.1679	252.50
7244F/45F Int Door Leaf - LH	SP313	PVPART.1680	252.50
7244F/45F Int Door Leaf - LH	SPBLK	PVPART.1681	252.50
7244F/45F Int Jamb Leaf - LH	US3	PVPART.1682	298.30
7244F/45F Int Jamb Leaf - LH	US10	PVPART.1683	298.30
7244F/45F Int Jamb Leaf - LH	US32	PVPART.1684	298.30
7244F/45F Int Jamb Leaf - LH	US32D	PVPART.1685	280.50
7244F/45F Int Jamb Leaf - LH	SP4	PVPART.1686	252.50
7244F/45F Int Jamb Leaf - LH	SP10	PVPART.1687	252.50
7244F/45F Int Jamb Leaf - LH	SP28	PVPART.1688	252.50
7244F/45F Int Jamb Leaf - LH	SP313	PVPART.1689	252.50
7244F/45F Int Jamb Leaf - LH	SPBLK	PVPART.1690	252.50
7215/26/27/30/37/44/45 Int Mounting Pkg	US3, SP4	PVPART.1434	14.90
7215/26/27/30/37/44/45 Int Mounting Pkg	US10, SP10	PVPART.1435	14.90
7215/26/27/30/37/44/45 Int Mounting Pkg	SP313	PVPART.1436	14.90
7215/26/27/30/37/44/45 Int Mounting Pkg	US32, US32D, SP28	PVPART.1437	14.90
7215/26/27/30/37/44/45 Int Mounting Pkg	SPBLK	PVPART.1438	14.90
7215/26/27/30/37/44/45 Int Security Mtg Pkg	-	PVPART.1439	35.70
7215/26/27/30/37/44/45 Int Wood Mtg Pkg	US3, SP4	PVPART.1836	16.30
7215/26/27/30/37/44/45 Int Wood Mtg Pkg	US10, SP10	PVPART.1837	16.30
7215/26/27/30/37/44/45 Int Wood Mtg Pkg	SP313	PVPART.1838	16.30
7215/26/27/30/37/44/45 Int Wood Mtg Pkg	US32, US32D, SP28	PVPART.1839	16.30
7215/26/27/30/37/44/45 Int Wood Mtg Pkg	SPBLK	PVPART.1840	16.30
7212/15/22/26/27/30/37/44/45 Cap Screw	US3	PVPART.1032	23.60
7212/15/22/26/27/30/37/44/45 Cap Screw	US10	PVPART.1034	23.60
7212/15/22/26/27/30/37/44/45 Cap Screw	US32	PVPART.1036	23.60
7212/15/22/26/27/30/37/44/45 Cap Screw	US32D	PVPART.1037	23.60
7212/15/22/26/27/30/37/44/45 Cap Screw	SP4	PVPART.1038	23.60
7212/15/22/26/27/30/37/44/45 Cap Screw	SP10	PVPART.1039	23.60
7212/15/22/26/27/30/37/44/45 Cap Screw	SP28	PVPART.1040	23.60
7212/15/22/26/27/30/37/44/45 Cap Screw	SP313	PVPART.1041	23.60
7212/15/22/26/27/30/37/44/45 Cap Screw	SPBLK	PVPART.1042	23.60
7230/37/44/45 Intermediate Pivot Ball	-	PVPART.1607	2.20
Pivot Bushing	-	PVPART.1870	3.60
Pivot Retainer Lock	-	PVPART.1353	8.80
Pivot Washer (Pkg of 10)	-	PVPART.1352	7.50
7215/26/27/30/37/44/45 Int Pivot Bearing Pin	-	PVPART.1847	14.90
7212 Bottom Pivot			
7212/12V/22 Btm Door Leaf - RH	US3	PVPART.1043	159.70
7212/12V/22 Btm Door Leaf - RH	US4	PVPART.1044	159.70
7212/12V/22 Btm Door Leaf - RH	US10	PVPART.1045	159.70
7212/12V/22 Btm Door Leaf - RH	US10B	PVPART.1046	159.70
7212/12V/22 Btm Door Leaf - RH	US26	PVPART.1047	159.70
7212/12V/22 Btm Door Leaf - RH	US26D	PVPART.1048	137.20
7212/12V/22 Btm Door Leaf - RH	SP4	PVPART.1049	104.70
7212/12V/22 Btm Door Leaf - RH	SP10	PVPART.1050	104.70
7212/12V/22 Btm Door Leaf - RH	SP28	PVPART.1051	104.70
7212/12V/22 Btm Door Leaf - RH	SP313	PVPART.1052	104.70
7212/12V/22 Btm Door Leaf - RH	SPBLK	PVPART.1053	104.70
7212/12V Btm Jamb Leaf - RH	US3	PVPART.1054	159.70
7212/12V Btm Jamb Leaf - RH	US4	PVPART.1055	159.70

Contact Ives Customer Service for pricing on additional sizes and finishes

Bold pricing indicates item is in stock and available for **Fast Track** and **ProXpress**

IVES ARCHITECTURAL HARDWARE - Parts Price List

Description	Finish	Part No.	List Price Each
7212 Bottom Pivot (Continued)			
7212/12V Btm Jamb Leaf - RH	US10	PVPART.1056	\$159.70
7212/12V Btm Jamb Leaf - RH	US10B	PVPART.1057	159.70
7212/12V Btm Jamb Leaf - RH	US26	PVPART.1058	159.70
7212/12V Btm Jamb Leaf - RH	US26D	PVPART.1059	137.20
7212/12V Btm Jamb Leaf - RH	SP4	PVPART.1060	104.70
7212/12V Btm Jamb Leaf - RH	SP10	PVPART.1061	104.70
7212/12V Btm Jamb Leaf - RH	SP28	PVPART.1062	104.70
7212/12V Btm Jamb Leaf - RH	SP313	PVPART.1063	104.70
7212/12V Btm Jamb Leaf - RH	SPBLK	PVPART.1064	104.70
7212/12V/22 Btm Door Leaf - LH	US3	PVPART.1065	159.70
7212/12V/22 Btm Door Leaf - LH	US4	PVPART.1066	159.70
7212/12V/22 Btm Door Leaf - LH	US10	PVPART.1067	159.70
7212/12V/22 Btm Door Leaf - LH	US10B	PVPART.1068	159.70
7212/12V/22 Btm Door Leaf - LH	US26	PVPART.1069	159.70
7212/12V/22 Btm Door Leaf - LH	US26D	PVPART.1070	137.20
7212/12V/22 Btm Door Leaf - LH	SP4	PVPART.1071	104.70
7212/12V/22 Btm Door Leaf - LH	SP10	PVPART.1072	104.70
7212/12V/22 Btm Door Leaf - LH	SP28	PVPART.1073	104.70
7212/12V/22 Btm Door Leaf - LH	SP313	PVPART.1074	104.70
7212/12V/22 Btm Door Leaf - LH	SPBLK	PVPART.1075	104.70
7212/12V Btm Jamb Leaf - LH	US3	PVPART.1076	159.70
7212/12V Btm Jamb Leaf - LH	US4	PVPART.1077	159.70
7212/12V Btm Jamb Leaf - LH	US10	PVPART.1078	159.70
7212/12V Btm Jamb Leaf - LH	US10B	PVPART.1079	159.70
7212/12V Btm Jamb Leaf - LH	US26	PVPART.1080	159.70
7212/12V Btm Jamb Leaf - LH	US26D	PVPART.1081	137.20
7212/12V Btm Jamb Leaf - LH	SP4	PVPART.1082	104.70
7212/12V Btm Jamb Leaf - LH	SP10	PVPART.1083	104.70
7212/12V Btm Jamb Leaf - LH	SP28	PVPART.1084	104.70
7212/12V Btm Jamb Leaf - LH	SP313	PVPART.1085	104.70
7212/12V Btm Jamb Leaf - LH	SPBLK	PVPART.1086	104.70
7212/12V/15 Btm Mounting Pkg	US3, US4, SP4	PVPART.1087	16.30
7212/12V/15 Btm Mounting Pkg	US10, SP10	PVPART.1088	16.30
7212/12V/15 Btm Mounting Pkg	US10B, SP313	PVPART.1089	16.30
7212/12V/15 Btm Mounting Pkg	US26, US26D, SP28	PVPART.1090	16.30
7212/12V/15 Btm Mounting Pkg	SPBLK	PVPART.1091	16.30
7212/12V/15 Btm Security Mounting Pkg	-	PVPART.1092	29.40
7212/12V/15/22 Btm Wood Mtg Pkg	US3, US4, SP4	PVPART.1826	14.90
7212/12V/15/22 Btm Wood Mtg Pkg	US10, SP10	PVPART.1827	14.90
7212/12V/15/22 Btm Wood Mtg Pkg	US10B, SP313	PVPART.1828	14.90
7212/12V/15/22 Btm Wood Mtg Pkg	US26, US26D, SP28	PVPART.1829	14.90
7212/12V/15/22 Btm Wood Mtg Pkg	SPBLK	PVPART.1830	14.90
Pivot Set Screw (Pkg of 10)	-	PVPART.1030	6.00
7212/12V/22 Pivot Bearing	-	PVPART.1031	6.00
7212/12V/22 Pivot Bearing Pin	-	PVPART.1093	6.00
7212V Bottom Pivot			
7212/12V/22 Btm Door Leaf - RH	US3	PVPART.1043	159.70
7212/12V/22 Btm Door Leaf - RH	US4	PVPART.1044	159.70
7212/12V/22 Btm Door Leaf - RH	US10	PVPART.1045	159.70
7212/12V/22 Btm Door Leaf - RH	US10B	PVPART.1046	159.70
7212/12V/22 Btm Door Leaf - RH	US26	PVPART.1047	159.70
7212/12V/22 Btm Door Leaf - RH	US26D	PVPART.1048	137.20
7212/12V/22 Btm Door Leaf - RH	SP4	PVPART.1049	104.70

Contact Ives Customer Service for pricing on additional sizes and finishes

Bold pricing indicates item is in stock and available for **Fast Track** and **ProXpress**

IVES ARCHITECTURAL HARDWARE - Parts Price List

Description	Finish	Part No.	List Price Each
7212V Bottom Pivot (Continued)			
7212/12V/22 Btm Door Leaf - RH	SP10	PVPART.1050	\$104.70
7212/12V/22 Btm Door Leaf - RH	SP28	PVPART.1051	104.70
7212/12V/22 Btm Door Leaf - RH	SP313	PVPART.1052	104.70
7212/12V/22 Btm Door Leaf - RH	SPBLK	PVPART.1053	104.70
7212/12V Btm Jamb Leaf - RH	US3	PVPART.1054	159.70
7212/12V Btm Jamb Leaf - RH	US4	PVPART.1055	159.70
7212/12V Btm Jamb Leaf - RH	US10	PVPART.1056	159.70
7212/12V Btm Jamb Leaf - RH	US10B	PVPART.1057	159.70
7212/12V Btm Jamb Leaf - RH	US26	PVPART.1058	159.70
7212/12V Btm Jamb Leaf - RH	US26D	PVPART.1059	137.20
7212/12V Btm Jamb Leaf - RH	SP4	PVPART.1060	104.70
7212/12V Btm Jamb Leaf - RH	SP10	PVPART.1061	104.70
7212/12V Btm Jamb Leaf - RH	SP28	PVPART.1062	104.70
7212/12V Btm Jamb Leaf - RH	SP313	PVPART.1063	104.70
7212/12V Btm Jamb Leaf - RH	SPBLK	PVPART.1064	104.70
7212/12V/22 Btm Door Leaf - LH	US3	PVPART.1065	159.70
7212/12V/22 Btm Door Leaf - LH	US4	PVPART.1066	159.70
7212/12V/22 Btm Door Leaf - LH	US10	PVPART.1067	159.70
7212/12V/22 Btm Door Leaf - LH	US10B	PVPART.1068	159.70
7212/12V/22 Btm Door Leaf - LH	US26	PVPART.1069	159.70
7212/12V/22 Btm Door Leaf - LH	US26D	PVPART.1070	137.20
7212/12V/22 Btm Door Leaf - LH	SP4	PVPART.1071	104.70
7212/12V/22 Btm Door Leaf - LH	SP10	PVPART.1072	104.70
7212/12V/22 Btm Door Leaf - LH	SP28	PVPART.1073	104.70
7212/12V/22 Btm Door Leaf - LH	SP313	PVPART.1074	104.70
7212/12V/22 Btm Door Leaf - LH	SPBLK	PVPART.1075	104.70
7212/12V Btm Jamb Leaf - LH	US3	PVPART.1076	159.70
7212/12V Btm Jamb Leaf - LH	US4	PVPART.1077	159.70
7212/12V Btm Jamb Leaf - LH	US10	PVPART.1078	159.70
7212/12V Btm Jamb Leaf - LH	US10B	PVPART.1079	159.70
7212/12V Btm Jamb Leaf - LH	US26	PVPART.1080	159.70
7212/12V Btm Jamb Leaf - LH	US26D	PVPART.1081	137.20
7212/12V Btm Jamb Leaf - LH	SP4	PVPART.1082	104.70
7212/12V Btm Jamb Leaf - LH	SP10	PVPART.1083	104.70
7212/12V Btm Jamb Leaf - LH	SP28	PVPART.1084	104.70
7212/12V Btm Jamb Leaf - LH	SP313	PVPART.1085	104.70
7212/12V Btm Jamb Leaf - LH	SPBLK	PVPART.1086	104.70
7212/12V/15/22 Btm Mounting Pkg	US3, US4, SP4	PVPART.1087	16.30
7212/12V/15/22 Btm Mounting Pkg	US10, SP10	PVPART.1088	16.30
7212/12V/15/22 Btm Mounting Pkg	US10B, SP313	PVPART.1089	16.30
7212/12V/15/22 Btm Mounting Pkg	US26, US26D, SP28	PVPART.1090	16.30
7212/12V/15/22 Btm Mounting Pkg	SPBLK	PVPART.1091	16.30
7212/12V/15 Btm Security Mtg Pkg	-	PVPART.1092	29.40
7212/12V/15/22 Btm Wood Mtg Pkg	US3, US4, SP4	PVPART.1826	14.90
7212/12V/15/22 Btm Wood Mtg Pkg	US10, SP10	PVPART.1827	14.90
7212/12V/15/22 Btm Wood Mtg Pkg	US10B, SP313	PVPART.1828	14.90
7212/12V/15/22 Btm Wood Mtg Pkg	US26, US26D, SP28	PVPART.1829	14.90
7212/12V/15/22 Btm Wood Mtg Pkg	SPBLK	PVPART.1830	14.90
Pivot Set Screw (Pkg of 10)	-	PVPART.1030	6.00
7212/12V/22 Pivot Bearing	-	PVPART.1031	6.00
7212/12V/22 Pivot Bearing Pin	-	PVPART.1093	6.00
7215 & 7215F Bottom Pivot			
7215 Btm Door Leaf - RH	US3	PVPART.1251	175.90

Contact Ives Customer Service for pricing on additional sizes and finishes

Bold pricing indicates item is in stock and available for **Fast Track** and **ProXpress**

IVES ARCHITECTURAL HARDWARE - Parts Price List

Description	Finish	Part No.	List Price Each
7215 & 7215F Bottom Pivot (Continued)			
7215 Btm Door Leaf - RH	US4	PVPART.1252	\$175.90
7215 Btm Door Leaf - RH	US10	PVPART.1253	175.90
7215 Btm Door Leaf - RH	US10B	PVPART.1254	175.90
7215 Btm Door Leaf - RH	US26	PVPART.1255	175.90
7215 Btm Door Leaf - RH	US26D	PVPART.1256	164.00
7215 Btm Door Leaf - RH	SP4	PVPART.1257	178.70
7215 Btm Door Leaf - RH	SP10	PVPART.1258	178.70
7215 Btm Door Leaf - RH	SP28	PVPART.1259	178.70
7215 Btm Door Leaf - RH	SP313	PVPART.1260	178.70
7215 Btm Door Leaf - RH	SPBLK	PVPART.1261	178.70
7215 Btm Jamb Leaf - RH	US3	PVPART.1262	175.90
7215 Btm Jamb Leaf - RH	US4	PVPART.1263	175.90
7215 Btm Jamb Leaf - RH	US10	PVPART.1264	175.90
7215 Btm Jamb Leaf - RH	US10B	PVPART.1265	175.90
7215 Btm Jamb Leaf - RH	US26	PVPART.1266	175.90
7215 Btm Jamb Leaf - RH	US26D	PVPART.1267	164.00
7215 Btm Jamb Leaf - RH	SP4	PVPART.1268	178.70
7215 Btm Jamb Leaf - RH	SP10	PVPART.1269	178.70
7215 Btm Jamb Leaf - RH	SP28	PVPART.1270	178.70
7215 Btm Jamb Leaf - RH	SP313	PVPART.1271	178.70
7215 Btm Jamb Leaf - RH	SPBLK	PVPART.1272	178.70
7215 Btm Door Leaf - LH	US3	PVPART.1273	175.90
7215 Btm Door Leaf - LH	US4	PVPART.1274	175.90
7215 Btm Door Leaf - LH	US10	PVPART.1275	175.90
7215 Btm Door Leaf - LH	US10B	PVPART.1276	175.90
7215 Btm Door Leaf - LH	US26	PVPART.1277	175.90
7215 Btm Door Leaf - LH	US26D	PVPART.1278	164.00
7215 Btm Door Leaf - LH	SP4	PVPART.1279	178.70
7215 Btm Door Leaf - LH	SP10	PVPART.1280	178.70
7215 Btm Door Leaf - LH	SP28	PVPART.1281	178.70
7215 Btm Door Leaf - LH	SP313	PVPART.1282	178.70
7215 Btm Door Leaf - LH	SPBLK	PVPART.1283	178.70
7215 Btm Jamb Leaf - LH	US3	PVPART.1284	175.90
7215 Btm Jamb Leaf - LH	US4	PVPART.1285	175.90
7215 Btm Jamb Leaf - LH	US10	PVPART.1286	175.90
7215 Btm Jamb Leaf - LH	US10B	PVPART.1287	175.90
7215 Btm Jamb Leaf - LH	US26	PVPART.1288	175.90
7215 Btm Jamb Leaf - LH	US26D	PVPART.1289	164.00
7215 Btm Jamb Leaf - LH	SP4	PVPART.1290	178.70
7215 Btm Jamb Leaf - LH	SP10	PVPART.1291	178.70
7215 Btm Jamb Leaf - LH	SP28	PVPART.1292	178.70
7215 Btm Jamb Leaf - LH	SP313	PVPART.1293	178.70
7215 Btm Jamb Leaf - LH	SPBLK	PVPART.1294	178.70
7215F Btm Door Leaf - RH	US3	PVPART.1295	313.10
7215F Btm Door Leaf - RH	US10	PVPART.1296	313.10
7215F Btm Door Leaf - RH	US32	PVPART.1297	313.10
7215F Btm Door Leaf - RH	US32D	PVPART.1298	290.90
7215F Btm Door Leaf - RH	SP4	PVPART.1299	230.60
7215F Btm Door Leaf - RH	SP10	PVPART.1300	230.60
7215F Btm Door Leaf - RH	SP28	PVPART.1301	230.60
7215F Btm Door Leaf - RH	SP313	PVPART.1302	230.60
7215F Btm Door Leaf - RH	SPBLK	PVPART.1303	230.60
7215F Btm Jamb Leaf - RH	US3	PVPART.1304	313.10

Contact Ives Customer Service for pricing on additional sizes and finishes

Bold pricing indicates item is in stock and available for **Fast Track** and **ProXpress**

IVES ARCHITECTURAL HARDWARE - Parts Price List

Description	Finish	Part No.	List Price Each
7215 & 7215F Bottom Pivot (Continued)			
7215F Btm Jamb Leaf - RH	US10	PVPART.1305	\$313.10
7215F Btm Jamb Leaf - RH	US32	PVPART.1306	313.10
7215F Btm Jamb Leaf - RH	US32D	PVPART.1307	290.90
7215F Btm Jamb Leaf - RH	SP4	PVPART.1308	230.60
7215F Btm Jamb Leaf - RH	SP10	PVPART.1309	230.60
7215F Btm Jamb Leaf - RH	SP28	PVPART.1310	230.60
7215F Btm Jamb Leaf - RH	SP313	PVPART.1311	230.60
7215F Btm Jamb Leaf - RH	SPBLK	PVPART.1312	230.60
7215F Btm Door Leaf - LH	US3	PVPART.1313	313.10
7215F Btm Door Leaf - LH	US10	PVPART.1314	313.10
7215F Btm Door Leaf - LH	US32	PVPART.1315	313.10
7215F Btm Door Leaf - LH	US32D	PVPART.1316	290.90
7215F Btm Door Leaf - LH	SP4	PVPART.1317	230.60
7215F Btm Door Leaf - LH	SP10	PVPART.1318	230.60
7215F Btm Door Leaf - LH	SP28	PVPART.1319	230.60
7215F Btm Door Leaf - LH	SP313	PVPART.1320	230.60
7215F Btm Door Leaf - LH	SPBLK	PVPART.1321	230.60
7215F Btm Jamb Leaf - LH	US3	PVPART.1322	313.10
7215F Btm Jamb Leaf - LH	US10	PVPART.1323	313.10
7215F Btm Jamb Leaf - LH	US32	PVPART.1324	313.10
7215F Btm Jamb Leaf - LH	US32D	PVPART.1325	290.90
7215F Btm Jamb Leaf - LH	SP4	PVPART.1326	230.60
7215F Btm Jamb Leaf - LH	SP10	PVPART.1327	230.60
7215F Btm Jamb Leaf - LH	SP28	PVPART.1328	230.60
7215F Btm Jamb Leaf - LH	SP313	PVPART.1329	230.60
7215F Btm Jamb Leaf - LH	SPBLK	PVPART.1330	230.60
7212/12V/15/22 Btm Mounting Pkg	US3, US4, SP4	PVPART.1087	16.30
7212/12V/15/22 Btm Mounting Pkg	US10, SP10	PVPART.1088	16.30
7212/12V/15/22 Btm Mounting Pkg	US10B, SP313	PVPART.1089	16.30
7212/12V/15/22 Btm Mounting Pkg	US26, US26D, US32, US32D, SP28	PVPART.1090	16.30
7212/12V/15/22 Btm Mounting Pkg	SPBLK	PVPART.1091	16.30
7212/12V/15/22 Btm Security Mtg Pkg	-	PVPART.1092	29.40
7212/12V/15/22 Btm Wood Mtg Pkg	US3, US4, SP4	PVPART.1826	14.90
7212/12V/15/22 Btm Wood Mtg Pkg	US10, SP10	PVPART.1827	14.90
7212/12V/15/22 Btm Wood Mtg Pkg	US10B, SP313	PVPART.1828	14.90
7212/12V/15/22 Btm Wood Mtg Pkg	US26, US26D, US32, US32D, SP28	PVPART.1829	14.90
7212/12V/15/22 Btm Wood Mtg Pkg	SPBLK	PVPART.1830	14.90
7212/15/22/26/27/30/37/44/45 Cap Screw	US3	PVPART.1032	23.60
7212/15/22/26/27/30/37/44/45 Cap Screw	US4	PVPART.1033	23.60
7212/15/22/26/27/30/37/44/45 Cap Screw	US10	PVPART.1034	23.60
7212/15/22/26/27/30/37/44/45 Cap Screw	US10B	PVPART.1035	23.60
7212/15/22/26/27/30/37/44/45 Cap Screw	US26, US32	PVPART.1036	23.60
7212/15/22/26/27/30/37/44/45 Cap Screw	US26D, US32D	PVPART.1037	23.60
7212/15/22/26/27/30/37/44/45 Cap Screw	SP4	PVPART.1038	23.60
7212/15/22/26/27/30/37/44/45 Cap Screw	SP10	PVPART.1039	23.60
7212/15/22/26/27/30/37/44/45 Cap Screw	SP28	PVPART.1040	23.60
7212/15/22/26/27/30/37/44/45 Cap Screw	SP313	PVPART.1041	23.60
7212/15/22/26/27/30/37/44/45 Cap Screw	SPBLK	PVPART.1042	23.60
7215/26/27 Pivot Ball	-	PVPART.1349	2.20
7215/15F Pivot Pin	-	PVPART.1350	10.40
Pivot Bearing Shaft	-	PVPART.1351	6.00
Pivot Washer (Pkg of 10)	-	PVPART.1352	7.50
Pivot Retainer Lock	-	PVPART.1353	8.80

Contact Ives Customer Service for pricing on additional sizes and finishes

Bold pricing indicates item is in stock and available for **Fast Track** and **ProXpress**

IVES ARCHITECTURAL HARDWARE - Parts Price List

Description	Finish	Part No.	List Price Each
7222 Bottom Pivot			
7212/12V/22 Btm Door Leaf - RH	US3	PVPART.1043	\$159.70
7212/12V/22 Btm Door Leaf - RH	US4	PVPART.1044	159.70
7212/12V/22 Btm Door Leaf - RH	US10	PVPART.1045	159.70
7212/12V/22 Btm Door Leaf - RH	US10B	PVPART.1046	159.70
7212/12V/22 Btm Door Leaf - RH	US26	PVPART.1047	159.70
7212/12V/22 Btm Door Leaf - RH	US26D	PVPART.1048	137.20
7212/12V/22 Btm Door Leaf - RH	SP4	PVPART.1049	104.70
7212/12V/22 Btm Door Leaf - RH	SP10	PVPART.1050	104.70
7212/12V/22 Btm Door Leaf - RH	SP28	PVPART.1051	104.70
7212/12V/22 Btm Door Leaf - RH	SP313	PVPART.1052	104.70
7212/12V/22 Btm Door Leaf - RH	SPBLK	PVPART.1053	104.70
7212/12V/22 Btm Door Leaf - LH	US3	PVPART.1065	159.70
7212/12V/22 Btm Door Leaf - LH	US4	PVPART.1066	159.70
7212/12V/22 Btm Door Leaf - LH	US10	PVPART.1067	159.70
7212/12V/22 Btm Door Leaf - LH	US10B	PVPART.1068	159.70
7212/12V/22 Btm Door Leaf - LH	US26	PVPART.1069	159.70
7212/12V/22 Btm Door Leaf - LH	US26D	PVPART.1070	137.20
7212/12V/22 Btm Door Leaf - LH	SP4	PVPART.1071	104.70
7212/12V/22 Btm Door Leaf - LH	SP10	PVPART.1072	104.70
7212/12V/22 Btm Door Leaf - LH	SP28	PVPART.1073	104.70
7212/12V/22 Btm Door Leaf - LH	SP313	PVPART.1074	104.70
7212/12V/22 Btm Door Leaf - LH	SPBLK	PVPART.1075	104.70
7222 Btm Cone Pkg	US3	PVPART.1440	147.80
7222 Btm Cone Pkg	US4	PVPART.1441	147.80
7222 Btm Cone Pkg	US10	PVPART.1442	147.80
7222 Btm Cone Pkg	US10B	PVPART.1443	147.80
7222 Btm Cone Pkg	US26	PVPART.1444	147.80
7222 Btm Cone Pkg	US26D	PVPART.1445	127.10
7222 Btm Cone Pkg	SP4	PVPART.1446	90.00
7222 Btm Cone Pkg	SP10	PVPART.1447	90.00
7222 Btm Cone Pkg	SP28	PVPART.1448	90.00
7222 Btm Cone Pkg	SP313	PVPART.1449	90.00
7222 Btm Cone Pkg	SPBLK	PVPART.1450	90.00
7222 Btm Mounting Pkg	-	PVPART.1451	26.40
7222 Security Mounting Pkg	-	PVPART.1452	14.90
Pivot Set Screw (Pkg of 10)	-	PVPART.1030	6.00
7212/12V/22 Pivot Bearing	-	PVPART.1031	6.00
7212/12V/22 Pivot Bearing Pin	-	PVPART.1093	6.00
7226 & 7226F Bottom Pivot			
7226/26F/27/27F Bottom Door Leaf	-	PVPART.1334	162.10
7226 Bottom Base Pkg	US3	PVPART.1453	166.90
7226 Bottom Base Pkg	US4	PVPART.1454	166.90
7226 Bottom Base Pkg	US10	PVPART.1455	166.90
7226 Bottom Base Pkg	US10B	PVPART.1456	166.90
7226 Bottom Base Pkg	US26	PVPART.1457	166.90
7226 Bottom Base Pkg	US26D	PVPART.1458	153.50
7226 Bottom Base Pkg	SP4	PVPART.1459	137.20
7226 Bottom Base Pkg	SP10	PVPART.1460	137.20
7226 Bottom Base Pkg	SP28	PVPART.1461	137.20
7226 Bottom Base Pkg	SP313	PVPART.1462	137.20
7226 Bottom Base Pkg	SPBLK	PVPART.1463	137.20
7226F/44F Bottom Base Pkg	US3	PVPART.1640	329.40

Contact Ives Customer Service for pricing on additional sizes and finishes

Bold pricing indicates item is in stock and available for **Fast Track** and **ProXpress**

IVES ARCHITECTURAL HARDWARE - Parts Price List

Description	Finish	Part No.	List Price Each
7226 & 7226F Bottom Pivot (Continued)			
7226F/44F Bottom Base Pkg	US10	PVPART.1641	\$329.40
7226F/44F Bottom Base Pkg	US32	PVPART.1642	329.40
7226F/44F Bottom Base Pkg	US32D	PVPART.1643	316.20
7226F/44F Bottom Base Pkg	SP4	PVPART.1644	280.50
7226F/44F Bottom Base Pkg	SP10	PVPART.1645	280.50
7226F/44F Bottom Base Pkg	SP28	PVPART.1646	280.50
7226F/44F Bottom Base Pkg	SP313	PVPART.1647	280.50
7226F/44F Bottom Base Pkg	SPBLK	PVPART.1648	280.50
7226/26F Bottom Mounting Pkg	US3, US4, SP4	PVPART.1464	45.70
7226/26F Bottom Mounting Pkg	US10, SP10	PVPART.1465	45.70
7226/26F Bottom Mounting Pkg	US10B, SP313	PVPART.1466	45.70
7226/26F Bottom Mounting Pkg	US26, US26D, SP28	PVPART.1467	45.70
7226/26F Bottom Mounting Pkg	SPBLK	PVPART.1468	45.70
7226/26F Security Mounting Pkg	-	PVPART.1469	35.70
7226/27/30F/37F/44F/45F Cover	US3	PVPART.1470	59.00
7226/27/30F/37F/44F/45F Cover	US4	PVPART.1471	59.00
7226/27/30F/37F/44F/45F Cover	US10	PVPART.1472	59.00
7226/27/30F/37F/44F/45F Cover	US10B	PVPART.1473	59.00
7226/27/30F/37F/44F/45F Cover	US26, US32	PVPART.1474	59.00
7226/27/30F/37F/44F/45F Cover	US26D, US32D	PVPART.1476	59.00
7226/27/30F/37F/44F/45F Cover	SP4	PVPART.1478	59.00
7226/27/30F/37F/44F/45F Cover	SP10	PVPART.1479	59.00
7226/27/30F/37F/44F/45F Cover	SP28	PVPART.1480	59.00
7226/27/30F/37F/44F/45F Cover	SP313	PVPART.1481	59.00
7226/27/30F/37F/44F/45F Cover	SPBLK	PVPART.1482	59.00
7226/27/30F/37F/44F/45F Cover Screw	US3	PVPART.1483	10.40
7226/27/30F/37F/44F/45F Cover Screw	US4, SP4	PVPART.1484	10.40
7226/27/30F/37F/44F/45F Cover Screw	US10, SP10	PVPART.1485	10.40
7226/27/30F/37F/44F/45F Cover Screw	US10B, SP313	PVPART.1486	10.40
7226/27/30F/37F/44F/45F Cover Screw	US26, US32	PVPART.1487	10.40
7226/27/30F/37F/44F/45F Cover Screw	US26D, US32D, SP28	PVPART.1488	10.40
7226/27/30F/37F/44F/45F Cover Screw	SPBLK	PVPART.1495	10.40
7226/27/37/44/45 Btm Pivot Bearing Pin	-	PVPART.1849	16.30
Pivot Set Screw (Pkg of 10)	-	PVPART.1030	6.00
7227 & 7227F Bottom Pivot			
7226/26F/27/27F Bottom Door Leaf	-	PVPART.1334	162.10
7227/27F/45F Base Pkg	-	PVPART.1497	542.20
7227/37/45/56/59 Finish Plate Pkg	US3	PVPART.1498	118.10
7227/37/45/56/59 Finish Plate Pkg	US4	PVPART.1499	118.10
7227/37/45/56/59 Finish Plate Pkg	US10	PVPART.1500	118.10
7227/37/45/56/59 Finish Plate Pkg	US10B	PVPART.1501	118.10
7227/37/45/56/59 Finish Plate Pkg	US26, US32	PVPART.1502	118.10
7227/37/45/56/59 Finish Plate Pkg	US26D, US32D	PVPART.1503	107.70
7227/37/45/56/59 Finish Plate Pkg	SP4	PVPART.1506	98.90
7227/37/45/56/59 Finish Plate Pkg	SP10	PVPART.1507	98.90
7227/37/45/56/59 Finish Plate Pkg	SP28	PVPART.1508	98.90
7227/37/45/56/59 Finish Plate Pkg	SP313	PVPART.1509	98.90
7227/37/45/56/59 Finish Plate Pkg	SPBLK	PVPART.1510	98.90
7227/7237F Bottom Mounting Pkg	US3, US4, SP4	PVPART.1511	45.70
7227/7237F Bottom Mounting Pkg	US10, SP10	PVPART.1512	45.70
7227/7237F Bottom Mounting Pkg	US10B, SP313	PVPART.1513	45.70
7227/7237F Bottom Mounting Pkg		PVPART.1514	45.70
7227/7237F Bottom Mounting Pkg	SPBLK	PVPART.1515	45.70
7227/7237F Bottom Security Mounting Pkg	-	PVPART.1516	47.20

Contact Ives Customer Service for pricing on additional sizes and finishes

Bold pricing indicates item is in stock and available for **Fast Track** and **ProXpress**

IVES ARCHITECTURAL HARDWARE - Parts Price List

Description	Finish	Part No.	List Price Each
7227 & 7227F Bottom Pivot (Continued)			
7226/27/30F/37F/44F/45F Cover	US3	PVPART.1470	\$59.00
7226/27/30F/37F/44F/45F Cover	US4	PVPART.1471	59.00
7226/27/30F/37F/44F/45F Cover	US10	PVPART.1472	59.00
7226/27/30F/37F/44F/45F Cover	US10B	PVPART.1473	59.00
7226/27/30F/37F/44F/45F Cover	US26, US32	PVPART.1474	59.00
7226/27/30F/37F/44F/45F Cover	US26D, US32D	PVPART.1476	59.00
7226/27/30F/37F/44F/45F Cover	SP4	PVPART.1478	59.00
7226/27/30F/37F/44F/45F Cover	SP10	PVPART.1479	59.00
7226/27/30F/37F/44F/45F Cover	SP28	PVPART.1480	59.00
7226/27/30F/37F/44F/45F Cover	SP313	PVPART.1481	59.00
7226/27/30F/37F/44F/45F Cover	SPBLK	PVPART.1482	59.00
7226/27/30F/37F/44F/45F Cover Screw	US3	PVPART.1483	10.40
7226/27/30F/37F/44F/45F Cover Screw	US4, SP4	PVPART.1484	10.40
7226/27/30F/37F/44F/45F Cover Screw	US10, SP10	PVPART.1485	10.40
7226/27/30F/37F/44F/45F Cover Screw	US10B, SP313	PVPART.1486	10.40
7226/27/30F/37F/44F/45F Cover Screw	US26, US32	PVPART.1487	10.40
7226/27/30F/37F/44F/45F Cover Screw	US26D, US32D, SP28	PVPART.1488	10.40
7226/27/30F/37F/44F/45F Cover Screw	SPBLK	PVPART.1495	10.40
7227/37/45/56/59 Finish Plate Screw (Pkg of 10)	-	PVPART.1335	2.20
7226/27/37/44/45 Btm Pivot Bearing Pin	-	PVPART.1849	16.30
Pivot Set Screw (Pkg of 10)	-	PVPART.1030	6.00
7230F Bottom Pivot			
7230F/37F Btm Door Leaf	-	PVPART.1545	180.20
7230F Btm Base Pkg	US3	PVPART.1546	329.40
7230F Btm Base Pkg	US10	PVPART.1547	329.40
7230F Btm Base Pkg	US32	PVPART.1548	329.40
7230F Btm Base Pkg	US32D	PVPART.1549	316.20
7230F Btm Base Pkg	SP4	PVPART.1550	280.50
7230F Btm Base Pkg	SP10	PVPART.1551	280.50
7230F Btm Base Pkg	SP28	PVPART.1552	280.50
7230F Btm Base Pkg	SP313	PVPART.1553	280.50
7230F Btm Base Pkg	SPBLK	PVPART.1554	280.50
7230F Btm Mounting Pkg	US3, SP4	PVPART.1555	48.80
7230F Btm Mounting Pkg	US10, SP10	PVPART.1556	48.80
7230F Btm Mounting Pkg	US32, US32D, SP28	PVPART.1557	48.80
7230F Btm Mounting Pkg	SP313	PVPART.1562	48.80
7230F Btm Mounting Pkg	SPBLK	PVPART.1563	48.80
7230F Btm Security Mtg Pkg	-	PVPART.1564	43.00
7226/27/30F/37F/44F/45F Cover	US3	PVPART.1470	59.00
7226/27/30F/37F/44F/45F Cover	US10	PVPART.1472	59.00
7226/27/30F/37F/44F/45F Cover	US32	PVPART.1474	59.00
7226/27/30F/37F/44F/45F Cover	US32D	PVPART.1476	59.00
7226/27/30F/37F/44F/45F Cover	SP4	PVPART.1478	59.00
7226/27/30F/37F/44F/45F Cover	SP10	PVPART.1479	59.00
7226/27/30F/37F/44F/45F Cover	SP28	PVPART.1480	59.00
7226/27/30F/37F/44F/45F Cover	SP313	PVPART.1481	59.00
7226/27/30F/37F/44F/45F Cover	SPBLK	PVPART.1482	59.00
7226/27/30F/37F/44F/45F Cover Screw	US3	PVPART.1483	10.40
7226/27/30F/37F/44F/45F Cover Screw	US10, SP10	PVPART.1485	10.40
7226/27/30F/37F/44F/45F Cover Screw	US32	PVPART.1487	10.40
7226/27/30F/37F/44F/45F Cover Screw	US32D, SP28	PVPART.1488	10.40
7226/27/30F/37F/44F/45F Cover Screw	SP4	PVPART.1484	10.40
7226/27/30F/37F/44F/45F Cover Screw	SP313	PVPART.1486	10.40

Contact Ives Customer Service for pricing on additional sizes and finishes

Bold pricing indicates item is in stock and available for **Fast Track** and **ProXpress**

IVES ARCHITECTURAL HARDWARE - Parts Price List

Description	Finish	Part No.	List Price Each
7230F Bottom Pivot (Continued)			
7226/27/30F/37F/44F/45F Cover Screw	SPBLK	PVPART.1495	\$10.40
7230F Pivot Bearing Pin	-	PVPART.1850	16.30
Pivot Set Screw (Pkg of 10)	-	PVPART.1030	6.00
7237F Bottom Pivot			
7230F/37F Btm Door Leaf	-	PVPART.1545	180.20
7237F Btm Base Pkg	-	PVPART.1608	542.20
7227/37/45/56/59 Finish Plate Pkg	US3	PVPART.1498	118.10
7227/37/45/56/59 Finish Plate Pkg	US10	PVPART.1500	118.10
7227/37/45/56/59 Finish Plate Pkg	US32	PVPART.1502	118.10
7227/37/45/56/59 Finish Plate Pkg	US32D	PVPART.1503	107.70
7227/37/45/56/59 Finish Plate Pkg	SP4	PVPART.1506	98.90
7227/37/45/56/59 Finish Plate Pkg	SPI0	PVPART.1507	98.90
7227/37/45/56/59 Finish Plate Pkg	SP28	PVPART.1508	98.90
7227/37/45/56/59 Finish Plate Pkg	SP313	PVPART.1509	98.90
7227/37/45/56/59 Finish Plate Pkg	SPBLK	PVPART.1510	98.90
7227/7237F Btm Mounting Pkg	US3, SP4	PVPART.1511	45.70
7227/7237F Btm Mounting Pkg	US10, SPI0	PVPART.1512	45.70
7227/7237F Btm Mounting Pkg	SP313	PVPART.1513	45.70
7227/7237F Btm Mounting Pkg	US32, US32D, SP28	PVPART.1514	45.70
7227/7237F Btm Mounting Pkg	SPBLK	PVPART.1515	45.70
7227/7237F Btm Security Mtg Pkg	-	PVPART.1516	47.20
7226/27/30F/37F/44F/45F Cover	US3	PVPART.1470	59.00
7226/27/30F/37F/44F/45F Cover	US10	PVPART.1472	59.00
7226/27/30F/37F/44F/45F Cover	US32	PVPART.1474	59.00
7226/27/30F/37F/44F/45F Cover	US32D	PVPART.1476	59.00
7226/27/30F/37F/44F/45F Cover	SP4	PVPART.1478	59.00
7226/27/30F/37F/44F/45F Cover	SPI0	PVPART.1479	59.00
7226/27/30F/37F/44F/45F Cover	SP28	PVPART.1480	59.00
7226/27/30F/37F/44F/45F Cover	SP313	PVPART.1481	59.00
7226/27/30F/37F/44F/45F Cover	SPBLK	PVPART.1482	59.00
7226/27/30F/37F/44F/45F Cover Screw	US3	PVPART.1483	10.40
7226/27/30F/37F/44F/45F Cover Screw	US10, SPI0	PVPART.1485	10.40
7226/27/30F/37F/44F/45F Cover Screw	US32	PVPART.1487	10.40
7226/27/30F/37F/44F/45F Cover Screw	US32D, SP28	PVPART.1488	10.40
7226/27/30F/37F/44F/45F Cover Screw	SP4	PVPART.1484	10.40
7226/27/30F/37F/44F/45F Cover Screw	SP313	PVPART.1486	10.40
7226/27/30F/37F/44F/45F Cover Screw	SPBLK	PVPART.1495	10.40
7227/37/45/56/59 Finish Plate Screw (Pkg of 10)	-	PVPART.1335	2.20
7226/27/37/44/45 Btm Pivot Bearing Pin	-	PVPART.1849	16.30
Pivot Set Screw (Pkg of 10)	-	PVPART.1030	6.00
7244F Bottom Pivot			
7244F/45F Bottom Door Leaf	-	PVPART.1639	180.20
7226/26F/44F Bottom Base Pkg	US3	PVPART.1640	329.40
7226/26F/44F Bottom Base Pkg	US10	PVPART.1641	329.40
7226/26F/44F Bottom Base Pkg	US32	PVPART.1642	329.40
7226/26F/44F Bottom Base Pkg	US32D	PVPART.1643	316.20
7226/26F/44F Bottom Base Pkg	SP4	PVPART.1644	280.50
7226/26F/44F Bottom Base Pkg	SPI0	PVPART.1645	280.50
7226/26F/44F Bottom Base Pkg	SP28	PVPART.1646	280.50
7226/26F/44F Bottom Base Pkg	SP313	PVPART.1647	280.50
7226/26F/44F Bottom Base Pkg	SPBLK	PVPART.1648	280.50
7244F/7245F Bottom Mounting Pkg	US3, SP4	PVPART.1649	45.70
7244F/7245F Bottom Mounting Pkg	US10, SPI0	PVPART.1650	45.70

Contact Ives Customer Service for pricing on additional sizes and finishes

Bold pricing indicates item is in stock and available for **Fast Track** and **ProXpress**

IVES ARCHITECTURAL HARDWARE - Parts Price List

Description	Finish	Part No.	List Price Each
7244F Bottom Pivot (Continued)			
7244F/7245F Bottom Mounting Pkg	US32, US32D, SP28	PVPART.1651	\$45.70
7244F/7245F Bottom Mounting Pkg	SP313	PVPART.1652	45.70
7244F/7245F Bottom Mounting Pkg	SPBLK	PVPART.1653	45.70
7244F/45F Bottom Security Mounting Pkg	-	PVPART.1654	39.70
7226/27/30F/37F/44F/45F Cover	US3	PVPART.1470	59.00
7226/27/30F/37F/44F/45F Cover	US10	PVPART.1472	59.00
7226/27/30F/37F/44F/45F Cover	US32	PVPART.1474	59.00
7226/27/30F/37F/44F/45F Cover	US32D	PVPART.1476	59.00
7226/27/30F/37F/44F/45F Cover	SP4	PVPART.1478	59.00
7226/27/30F/37F/44F/45F Cover	SP10	PVPART.1479	59.00
7226/27/30F/37F/44F/45F Cover	SP28	PVPART.1480	59.00
7226/27/30F/37F/44F/45F Cover	SP313	PVPART.1481	59.00
7226/27/30F/37F/44F/45F Cover	SPBLK	PVPART.1482	59.00
7226/27/30F/37F/44F/45F Cover Screw	US3	PVPART.1483	10.40
7226/27/30F/37F/44F/45F Cover Screw	US10, SP10	PVPART.1485	10.40
7226/27/30F/37F/44F/45F Cover Screw	US32	PVPART.1487	10.40
7226/27/30F/37F/44F/45F Cover Screw	US32D, SP28	PVPART.1488	10.40
7226/27/30F/37F/44F/45F Cover Screw	SP4	PVPART.1484	10.40
7226/27/30F/37F/44F/45F Cover Screw	SP313	PVPART.1486	10.40
7226/27/30F/37F/44F/45F Cover Screw	SPBLK	PVPART.1495	10.40
7226/27/37/44/45 Btm Pivot Bearing Pin	-	PVPART.1849	16.30
Pivot Set Screw (Pkg of 10)	-	PVPART.1030	6.00
7245F Bottom Pivot			
7244F/45F Bottom Door Leaf	-	PVPART.1639	180.20
72/27/27F/45F Bottom Base Pkg	-	PVPART.1497	542.20
7227/37/45/56/59 Finish Plate Pkg	US3	PVPART.1498	118.10
7227/37/45/56/59 Finish Plate Pkg	US10	PVPART.1500	118.10
7227/37/45/56/59 Finish Plate Pkg	US32	PVPART.1502	118.10
7227/37/45/56/59 Finish Plate Pkg	US32D	PVPART.1503	107.70
7227/37/45/56/59 Finish Plate Pkg	SP4	PVPART.1506	98.90
7227/37/45/56/59 Finish Plate Pkg	SP10	PVPART.1507	98.90
7227/37/45/56/59 Finish Plate Pkg	SP28	PVPART.1508	98.90
7227/37/45/56/59 Finish Plate Pkg	SP313	PVPART.1509	98.90
7227/37/45/56/59 Finish Plate Pkg	SPBLK	PVPART.1510	98.90
7244F/45F Bottom Mounting Pkg	US3, SP4	PVPART.1649	45.70
7244F/45F Bottom Mounting Pkg	US10, SP10	PVPART.1650	45.70
7244F/45F Bottom Mounting Pkg	US32, US32D, SP28	PVPART.1651	45.70
7244F/45F Bottom Mounting Pkg	SP313	PVPART.1652	45.70
7244F/45F Bottom Mounting Pkg	SPBLK	PVPART.1653	45.70
7245F Bottom Security Mtg Pkg	-	PVPART.1654	39.70
7226/27/30F/37F/44F/45F Cover	US3	PVPART.1470	59.00
7226/27/30F/37F/44F/45F Cover	US10	PVPART.1472	59.00
7226/27/30F/37F/44F/45F Cover	US32	PVPART.1474	59.00
7226/27/30F/37F/44F/45F Cover	US32D	PVPART.1476	59.00
7226/27/30F/37F/44F/45F Cover	SP4	PVPART.1478	59.00
7226/27/30F/37F/44F/45F Cover	SP10	PVPART.1479	59.00
7226/27/30F/37F/44F/45F Cover	SP28	PVPART.1480	59.00
7226/27/30F/37F/44F/45F Cover	SP313	PVPART.1481	59.00
7226/27/30F/37F/44F/45F Cover	SPBLK	PVPART.1482	59.00
7226/27/30F/37F/44F/45F Cover Screw	US3	PVPART.1483	10.40
7226/27/30F/37F/44F/45F Cover Screw	US10, SP10	PVPART.1485	10.40
7226/27/30F/37F/44F/45F Cover Screw	US32	PVPART.1487	10.40
7226/27/30F/37F/44F/45F Cover Screw	US32D, SP28	PVPART.1488	10.40

Contact Ives Customer Service for pricing on additional sizes and finishes

Bold pricing indicates item is in stock and available for **Fast Track** and **ProXpress**

IVES ARCHITECTURAL HARDWARE - Parts Price List

Description	Finish	Part No.	List Price Each
7245F Bottom Pivot (Continued)			
7226/27/30F/37F/44F/45F Cover Screw	SP4	PVPART.1484	\$10.40
7226/27/30F/37F/44F/45F Cover Screw	SP313	PVPART.1486	10.40
7226/27/30F/37F/44F/45F Cover Screw	SPBLK	PVPART.1495	10.40
7226/27/37/44/45 Btm Pivot Bearing Pin	-	PVPART.1849	16.30
Pivot Set Screw (Pkg of 10)	-	PVPART.1030	6.00
7227/37/45/56/59 Finish Plate Screw (Pkg of 10)	-	PVPART.1335	2.20
7253 Bottom Pivot			
7253 Btm Door Leaf	-	PVPART.1735	180.20
7253 Btm Base	US3	PVPART.1736	72.60
7253 Btm Base	US4	PVPART.1737	72.60
7253 Btm Base	US10	PVPART.1738	72.60
7253 Btm Base	US10B	PVPART.1739	72.60
7253 Btm Base	US26	PVPART.1740	72.60
7253 Btm Base	US26D	PVPART.1741	72.60
7253 Btm Base	SP4	PVPART.1742	63.40
7253 Btm Base	SP10	PVPART.1743	63.40
7253 Btm Base	SP28	PVPART.1744	63.40
7253 Btm Base	SP313	PVPART.1745	63.40
7253 Btm Base	SPBLK	PVPART.1746	63.40
7253 Bearing	-	PVPART.1704	23.60
7253 Btm Mounting Pkg	-	PVPART.1747	54.60
7253 Btm Security Mounting Pkg	-	PVPART.1748	10.40
7255 Bottom Pivot			
7255/55J Bottom Door Leaf	-	PVPART.1749	135.90
7255 Btm Base	US3	PVPART.1750	119.50
7255 Btm Base	US4	PVPART.1751	119.50
7255 Btm Base	US10	PVPART.1752	119.50
7255 Btm Base	US10B	PVPART.1753	119.50
7255 Btm Base	US26	PVPART.1754	119.50
7255 Btm Base	US26D	PVPART.1755	119.50
7255 Btm Base	SP4	PVPART.1756	113.90
7255 Btm Base	SP10	PVPART.1757	113.90
7255 Btm Base	SP28	PVPART.1758	113.90
7255 Btm Base	SP313	PVPART.1759	113.90
7255 Btm Base	SPBLK	PVPART.1760	113.90
7255 Btm Mounting Pkg	US3, US4, SP4	PVPART.1761	22.20
7255 Btm Mounting Pkg	US10, SP10	PVPART.1762	22.20
7255 Btm Mounting Pkg	US10B, SP313	PVPART.1763	22.20
7255 Btm Mounting Pkg	US26, US26D, SP28	PVPART.1764	22.20
7255 Btm Mounting Pkg	SPBLK	PVPART.1765	22.20
7255 Btm Security Mounting Pkg	-	PVPART.1766	25.10
7255J Bottom Pivot			
7255/55J Bottom Door Leaf	-	PVPART.1749	135.90
7255J Bottom Base	US3	PVPART.1767	119.50
7255J Bottom Base	US4	PVPART.1768	119.50
7255J Bottom Base	US10	PVPART.1769	119.50
7255J Bottom Base	US10B	PVPART.1770	119.50
7255J Bottom Base	US26	PVPART.1771	119.50
7255J Bottom Base	US26D	PVPART.1772	119.50
7255J Bottom Base	SP4	PVPART.1773	113.90
7255J Bottom Base	SP10	PVPART.1774	113.90
7255J Bottom Base	SP28	PVPART.1775	113.90
7255J Bottom Base	SP313	PVPART.1776	113.90

Contact Ives Customer Service for pricing on additional sizes and finishes

Bold pricing indicates item is in stock and available for **Fast Track** and **ProXpress**

IVES ARCHITECTURAL HARDWARE - Parts Price List

Description	Finish	Part No.	List Price Each
7255J Bottom Pivot (Continued)			
7255J Bottom Base	SPBLK	PVPART.1777	\$113.90
7255J Bottom Mounting Pkg	US3, US4, SP4	PVPART.1778	14.90
7255J Bottom Mounting Pkg	US10, SP10	PVPART.1779	14.90
7255J Bottom Mounting Pkg	US10B, SP313	PVPART.1780	14.90
7255J Bottom Mounting Pkg	US26, US26D, SP28	PVPART.1781	14.90
7255J Bottom Mounting Pkg	SPBLK	PVPART.1782	14.90
7255J Btm Security Mtg Pkg	-	PVPART.1783	22.20
7255J Bottom Wood Mtg Pkg	US3, US4, SP4	PVPART.1864	10.40
7255J Bottom Wood Mtg Pkg	US10, SP10	PVPART.1865	10.40
7255J Bottom Wood Mtg Pkg	US10B, SP313	PVPART.1866	10.40
7255J Bottom Wood Mtg Pkg	US26, US26D, SP28	PVPART.1867	10.40
7255J Bottom Wood Mtg Pkg	SPBLK	PVPART.1868	10.40
7256 Bottom Pivot			
7256 Btm Door Leaf	-	PVPART.1784	135.90
7256 Btm Base Pkg	-	PVPART.1785	497.60
7227/37/45/56/59 Finish Plate Pkg	US3	PVPART.1498	118.10
7227/37/45/56/59 Finish Plate Pkg	US4	PVPART.1499	118.10
7227/37/45/56/59 Finish Plate Pkg	US10	PVPART.1500	118.10
7227/37/45/56/59 Finish Plate Pkg	US10B	PVPART.1501	118.10
7227/37/45/56/59 Finish Plate Pkg	US26	PVPART.1502	118.10
7227/37/45/56/59 Finish Plate Pkg	US26D	PVPART.1503	107.70
7227/37/45/56/59 Finish Plate Pkg	SP4	PVPART.1506	98.90
7227/37/45/56/59 Finish Plate Pkg	SP10	PVPART.1507	98.90
7227/37/45/56/59 Finish Plate Pkg	SP28	PVPART.1508	98.90
7227/37/45/56/59 Finish Plate Pkg	SP313	PVPART.1509	98.90
7227/37/45/56/59 Finish Plate Pkg	SPBLK	PVPART.1510	98.90
7256 Btm Mounting Pkg	-	PVPART.1786	10.40
7256 Btm Security Mounting Pkg	-	PVPART.1787	14.90
7227/37/45/56/59 Finish Plate Screw (Pkg of 10)	-	PVPART.1335	2.20
7259 Bottom Pivot			
7259 Btm Door Leaf	-	PVPART.1817	272.00
7259 Btm Base Kit	-	PVPART.1818	723.60
7227/37/45/56/59 Finish Plate Pkg	US3	PVPART.1498	118.10
7227/37/45/56/59 Finish Plate Pkg	US4	PVPART.1499	118.10
7227/37/45/56/59 Finish Plate Pkg	US10	PVPART.1500	118.10
7227/37/45/56/59 Finish Plate Pkg	US10B	PVPART.1501	118.10
7227/37/45/56/59 Finish Plate Pkg	US26	PVPART.1502	118.10
7227/37/45/56/59 Finish Plate Pkg	US26D	PVPART.1503	107.70
7227/37/45/56/59 Finish Plate Pkg	SP4	PVPART.1506	98.90
7227/37/45/56/59 Finish Plate Pkg	SP10	PVPART.1507	98.90
7227/37/45/56/59 Finish Plate Pkg	SP28	PVPART.1508	98.90
7227/37/45/56/59 Finish Plate Pkg	SP313	PVPART.1509	98.90
7227/37/45/56/59 Finish Plate Pkg	SPBLK	PVPART.1510	98.90
7259 Btm Mounting Pkg	-	PVPART.1819	14.90
7259 Btm Security Mtg Pkg	-	PVPART.1820	32.40
91105 Pocket Pivot			
91105 Pocket Pivot Mtg Pkg	US3	PVPART.1188	22.20
91105 Pocket Pivot Mtg Pkg	US10	PVPART.1189	22.20
91105 Pocket Pivot Mtg Pkg	US32, US32D, USP	PVPART.1190	22.20
91105 Pocket Pivot Mtg Pkg	SP313	PVPART.1191	22.20
AS18			
AS18 Mounting Pkg	US3, US4	ASPART.1001	6.80
AS18 Mounting Pkg	US10	ASPART.1002	6.80

Contact Ives Customer Service for pricing on additional sizes and finishes

Bold pricing indicates item is in stock and available for **Fast Track** and **ProXpress**

IVES ARCHITECTURAL HARDWARE - Parts Price List

Description	Finish	Part No.	List Price Each
AS18 (Continued)			
AS18 Mounting Pkg	US10B	ASPART.1003	\$6.80
AS18 Mounting Pkg	US26, US26D	ASPART.1004	6.80
Silencer (Pkg of 10)	-	ASPART.1005	6.80
AS18 Security Mounting Pkg	-	ASPART.1006	13.50
AS895			
AS895 Mounting Pkg	US3, US4	ASPART.1007	6.80
AS895 Mounting Pkg	US10	ASPART.1008	6.80
AS895 Mounting Pkg	US10B	ASPART.1009	6.80
AS895 Mounting Pkg	US26, US26D	ASPART.1010	6.80
AS895 Security Mounting Pkg	-	ASPART.1011	13.50
CBI			
CBI Roller & Pin Pkg	-	CBPART.1001	6.80
CBI Mounting Pkg	US3, US4	CBPART.1002	17.40
CBI Mounting Pkg	US10	CBPART.1003	17.40
CBI Mounting Pkg	US10B	CBPART.1004	17.40
CBI Mounting Pkg	USP, US26, US26D	CBPART.1005	17.40
CBI Mounting Pkg	SPBLK	CBPART.1006	17.40
CBI Security Mounting Pkg	-	CBPART.1007	10.20
CL11			
CL11 Mounting Pkg	US3, US4	CLPART.1001	8.50
CL11 Mounting Pkg	US10	CLPART.1002	8.50
CL11 Mounting Pkg	US26D	CLPART.1003	8.50
CL11 Hook Pkg	US3	CLPART.1004	20.40
CL11 Hook Pkg	US4	CLPART.1005	17.40
CL11 Hook Pkg	US10	CLPART.1006	17.40
CL11 Hook Pkg	US26D	CLPART.1007	17.40
CL11 Security Mounting Pkg	-	CLPART.1008	17.40
CL12			
CL12 Mounting Pkg	US3, US4	CLPART.1009	8.50
CL12 Mounting Pkg	US10	CLPART.1010	8.50
CL12 Mounting Pkg	US26D	CLPART.1011	8.50
CL12 Hook Pkg	US3	CLPART.1012	20.40
CL12 Hook Pkg	US4	CLPART.1013	17.40
CL12 Hook Pkg	US10	CLPART.1014	17.40
CL12 Hook Pkg	US26D	CLPART.1015	17.40
CL12 Security Mounting Pkg	-	CLPART.1016	20.40
CL14			
CL14 Mounting Pkg	US3, US4	CLPART.1017	5.10
CL14 Mounting Pkg	US10	CLPART.1018	5.10
CL14 Mounting Pkg	US26D	CLPART.1019	5.10
CL14 Security Mounting Pkg	-	CLPART.1020	6.80
CL21			
CL21 Mounting Package	US26D	CLPART.1021	5.10
CL21 Hook Package	US26D	CLPART.1022	24.10
CL21 Security Mounting Package	-	CLPART.1023	6.80
CL21A			
CL21A Mounting Package	US3, US4	CLPART.1024	6.80
CL21A Mounting Package	US10	CLPART.1025	6.80
CL21A Mounting Package	US26, US26D	CLPART.1027	6.80
CL21A Hook Package	US3	CLPART.1028	24.10
CL21A Hook Package	US4	CLPART.1029	20.40
CL21A Hook Package	US10	CLPART.1030	20.40
CL21A Hook Package	US26	CLPART.1032	24.10

Contact Ives Customer Service for pricing on additional sizes and finishes

Bold pricing indicates item is in stock and available for **Fast Track** and **ProXpress**

IVES ARCHITECTURAL HARDWARE - Parts Price List

Description	Finish	Part No.	List Price Each
CL21A (continued)			
CL21A Hook Package	US26D	CLPART.1033	\$20.40
CL21A Security Mounting Package	-	CLPART.1034	13.50
CL22			
CL22 Mounting Pkg	US3, US4	CLPART.1035	6.80
CL22 Mounting Pkg	US10	CLPART.1036	6.80
CL22 Mounting Pkg	US26, US26D	CLPART.1038	6.80
CL22 Hook Pkg	US3	CLPART.1039	17.40
CL22 Hook Pkg	US4	CLPART.1040	13.50
CL22 Hook Pkg	US10	CLPART.1041	13.50
CL22 Hook Pkg	US26	CLPART.1043	17.40
CL22 Hook Pkg	US26D	CLPART.1044	13.50
CL22 Security Mounting Pkg	-	CLPART.1045	13.50
COR7G/COR9G			
COR7G/9G Nylon Roller & Bolt Pkg	US3,US4	CORPART.1001	25.60
COR7G/9G Nylon Roller & Bolt Pkg	US10	CORPART.1022	25.60
COR7G/9G Nylon Roller & Bolt Pkg	US10B	CORPART.1023	25.60
COR7G/9G Nylon Roller & Bolt Pkg	US26,US26D	CORPART.1024	25.60
COR7G/9G Rubber Roller & Pin Pkg	-	CORPART.1002	10.20
COR7G/9G Door Bracket Pkg	US3	CORPART.1003	30.70
COR7G/9G Door Bracket Pkg	US4	CORPART.1004	30.70
COR7G/9G Door Bracket Pkg	US10	CORPART.1005	30.70
COR7G/9G Door Bracket Pkg	US10B	CORPART.1006	30.70
COR7G/9G Door Bracket Pkg	US26	CORPART.1007	30.70
COR7G/9G Door Bracket Pkg	US26D	CORPART.1008	30.70
COR7G/9G Rub Plate Pkg	-	CORPART.1009	6.80
COR7G/9G Mounting Pkg	US3, US4	CORPART.1010	20.40
COR7G/9G Mounting Pkg	US10	CORPART.1011	20.40
COR7G/9G Mounting Pkg	US10B	CORPART.1012	20.40
COR7G/9G Mounting Pkg	US26, US26D	CORPART.1013	20.40
COR7G/9G Security Mounting Pkg	-	CORPART.1021	24.10
COR32/COR42/COR52/COR60/COR72			
COR32/42/52/60/72 Rub Plate (Pkg of 2)	-	CORPART.1014	11.50
COR32/42/52/60/72 Mounting Pkg	US28, US26D	CORPART.1018	11.50
COR32/42/52/60/72 Mounting Pkg	315AN	CORPART.1019	31.10
COR32/42/52/60/72 Security Mounting Pkg	-	CORPART.1020	41.30
CS115			
CS115/SB453/454/0454 Thru Bolt with Cap Nut Pkg (Set of 4)	US26D	09-340-626	9.90
Sex Bolt Pkg	US26D, US2C	09-351-604	18.20
DP2			
DP2 Plate Pkg	US3	DPPART.1001	13.50
DP2 Plate Pkg	US4	DPPART.1002	13.50
DP2 Plate Pkg	US10	DPPART.1003	13.50
DP2 Plate Pkg	US10B	DPPART.1004	13.50
DP2 Plate Pkg	US26	DPPART.1005	13.50
DP2 Plate Pkg	US26D	DPPART.1006	13.50
DP2 Mounting Pkg	US3, US4	DPPART.1007	5.10
DP2 Mounting Pkg	US10	DPPART.1008	5.10
DP2 Mounting Pkg	US10B	DPPART.1009	5.10
DP2 Mounting Pkg	US26, US26D	DPPART.1010	5.10
DP2 Security Mounting Pkg	-	DPPART.1011	6.80
FB30 Series - Metal Door Automatic Flushbolt			
FB30T Face Plate Pkg	US3	FBPART.1001	45.90
FB30T Face Plate Pkg	US4	FBPART.1002	45.90
FB30T Face Plate Pkg	US10	FBPART.1003	45.90

Contact Ives Customer Service for pricing on additional sizes and finishes

Bold pricing indicates item is in stock and available for **Fast Track** and **ProXpress**

IVES ARCHITECTURAL HARDWARE - Parts Price List

Description	Finish	Part No.	List Price Each
FB30 Series - Metal Door Automatic Flushbolt (Continued)			
FB30T Face Plate Pkg	US10B	FBPART.1004	\$45.90
FB30T Face Plate Pkg	US32	FBPART.1005	45.90
FB30T Face Plate Pkg	US32D	FBPART.1006	45.90
FB30T Face Plate Pkg	BLK	FBPART.1092	45.90
FB30B/50B Face Plate Pkg	US3	FBPART.1007	45.90
FB30B/50B Face Plate Pkg	US4	FBPART.1008	45.90
FB30B/50B Face Plate Pkg	US10	FBPART.1009	45.90
FB30B/50B Face Plate Pkg	US10B	FBPART.1010	45.90
FB30B/50B Face Plate Pkg	US32	FBPART.1011	45.90
FB30B/50B Face Plate Pkg	US32D	FBPART.1012	45.90
FB30B/50B Face Plate Pkg	BLK	FBPART.1093	45.90
FB30/50 Guide Pkg	-	FBPART.1013	8.50
FB30/40/50/60 Rub Plate & Shim Pkg	-	FBPART.1014	3.50
FB30/40/50B/60B Auxiliary Bolt	-	FBPART.1015	5.10
FB30/50B 8 3/4" Rod - 12" Rod & Bolt Tip Kit	-	FBPART.1016	13.50
FB30/50B Bolt Tip	-	FBPART.1017	13.50
FB30/50 8 3/4" - 12" Rod Only	-	FBPART.1018	6.80
FB30/50 7 1/2" Rod - 9"	-	FBPART.1019	13.50
FB30/50 16 1/2" Rod- 18"	-	FBPART.1020	13.50
FB30/50 22 1/2" Rod - 24"	-	FBPART.1021	13.50
FB30/50 28 1/2" Rod - 30"	-	FBPART.1022	13.50
FB30/50 34 1/2" Rod - 36"	-	FBPART.1023	13.50
FB30/50 46 1/2" Rod- 48"	-	FBPART.1024	13.50
FB30/40/50B/60B Strike Pkg	US3, US4	FBPART.1025	10.20
FB30/40/50B/60B Strike Pkg	US10	FBPART.1026	10.20
FB30/40/50B/60B Strike Pkg	US10B	FBPART.1027	10.20
FB30/40/50B/60B Strike Pkg	US32, US32D	FBPART.1028	10.20
FB30/40/50B/60B Strike Pkg	BLK	FBPART.1094	10.20
FB30/50 Mounting Pkg	US3, US4	FBPART.1029	24.10
FB30/50 Mounting Pkg	US10	FBPART.1030	24.10
FB30/50 Mounting Pkg	US10B	FBPART.1031	24.10
FB30/50 Mounting Pkg	US32, US32D	FBPART.1032	24.10
FB30/50 Mounting Pkg	BLK	FBPART.1095	24.10
FB30/50 Security Mounting Pkg	-	FBPART.1033	40.90
FB32/42/52/62 AFL Plug/Screw Pkg	-	FBPART.1034	6.00
FB32/42/52/62 Auxiliary Fire Latch	-	FBPART.1035	145.10
FB30/50 Retrofit Pkg	-	FBPART.1065	11.50
FB30/40/50/60 Face Plate Screws, Pkg 10	US3, US4	FBPART.1066	7.50
FB30/40/50/60 Face Plate Screws, Pkg 10	US10	FBPART.1067	7.50
FB30/40/50/60 Face Plate Screws, Pkg 10	US10B	FBPART.1068	7.50
FB30/40/50/60 Face Plate Screws, Pkg 10	US32, US32D	FBPART.1069	7.50
FB30/40/50/60 Face Plate Screws. Pkg 10	BLK	FBPART.1101	7.50
FB40 Series - Wood Door Automatic Flushbolt			
FB40T Face Plate Pkg	US3	FBPART.1036	45.90
FB40T Face Plate Pkg	US4	FBPART.1037	45.90
FB40T Face Plate Pkg	US10	FBPART.1038	45.90
FB40T Face Plate Pkg	US10B	FBPART.1039	45.90
FB40T Face Plate Pkg	US32	FBPART.1040	45.90
FB40T Face Plate Pkg	US32D	FBPART.1041	45.90
FB40T Face Plate Pkg	BLK	FBPART.1097	45.90
FB40B/60B Face Plate Pkg	US3	FBPART.1042	45.90
FB40B/60B Face Plate Pkg	US4	FBPART.1043	45.90
FB40B/60B Face Plate Pkg	US10	FBPART.1044	45.90

Contact Ives Customer Service for pricing on additional sizes and finishes

Bold pricing indicates item is in stock and available for **Fast Track** and **ProXpress**

IVES ARCHITECTURAL HARDWARE - Parts Price List

Description	Finish	Part No.	List Price Each
FB40 Series - Wood Door Automatic Flushbolt (Continued)			
FB40B/60B Face Plate Pkg	US10B	FBPART.1045	\$45.90
FB40B/60B Face Plate Pkg	US32	FBPART.1046	45.90
FB40B/60B Face Plate Pkg	US32D	FBPART.1047	45.90
FB40T Face Plate Pkg	BLK	FBPART.1097	45.90
FB30/40/50/60 Rub Plate & Shim Pkg	-	FBPART.1014	3.50
FB40/60 Guide Pkg	-	FBPART.1048	10.20
FB40/60 Cover	-	FBPART.1049	6.80
FB30/40/50B/60B Auxiliary Bolt	-	FBPART.1015	5.10
FB40/60B Rod & Bolt Tip Kit	-	FBPART.1050	10.20
FB40/60B Bolt Tip	-	FBPART.1051	5.10
FB40/60 Rod - 2 1/2"	-	FBPART.1052	5.10
FB30/40/50B/60B Strike Pkg	US3, US4	FBPART.1025	10.20
FB30/40/50B/60B Strike Pkg	US10	FBPART.1026	10.20
FB30/40/50B/60B Strike Pkg	US10B	FBPART.1027	10.20
FB30/40/50B/60B Strike Pkg	US32, US32D	FBPART.1028	10.20
FB30/40/50B/60B Strike Pkg	BLK	FBPART.1094	10.20
FB40/60 Mounting Pkg	US3, US4	FBPART.1053	24.10
FB40/60 Mounting Pkg	US10	FBPART.1054	24.10
FB40/60 Mounting Pkg	US10B	FBPART.1055	24.10
FB40/60 Mounting Pkg	US32, US32D	FBPART.1056	24.10
FB40/60 Mounting Pkg		FBPART.1099	24.10
FB40/60 Security Mounting Pkg	-	FBPART.1057	37.60
FB32/42/52/62 AFL Plug/Screw Pkg	-	FBPART.1034	6.00
FB32/42/52/62 Auxiliary Fire Latch	-	FBPART.1035	145.10
FB30/40/50/60 Face Plate Screws. Pkg 10	US3, US4	FBPART.1066	7.50
FB30/40/50/60 Face Plate Screws. Pkg 10	US10	FBPART.1067	7.50
FB30/40/50/60 Face Plate Screws. Pkg 10	US10B	FBPART.1068	7.50
FB30/40/50/60 Face Plate Screws. Pkg 10	US32, US32D	FBPART.1069	7.50
FB30/40/50/60 Face Plate Screws. Pkg 10	BLK	FBPART.1101	7.50
FB50 Series - Metal Door Constant Latching Flushbolt			
FB50T Face Plate Pkg	US3	FBPART.1058	45.90
FB50T Face Plate Pkg	US4	FBPART.1059	45.90
FB50T Face Plate Pkg	US10	FBPART.1060	45.90
FB50T Face Plate Pkg	US10B	FBPART.1061	45.90
FB50T Face Plate Pkg	US32	FBPART.1062	45.90
FB50T Face Plate Pkg	US32D	FBPART.1063	45.90
FB50T Face Plate Pkg	BLK	FBPART.1100	45.90
FB30B/50B Face Plate Pkg	US3	FBPART.1007	45.90
FB30B/50B Face Plate Pkg	US4	FBPART.1008	45.90
FB30B/50B Face Plate Pkg	US10	FBPART.1009	45.90
FB30B/50B Face Plate Pkg	US10B	FBPART.1010	45.90
FB30B/50B Face Plate Pkg	US32	FBPART.1011	45.90
FB30B/50B Face Plate Pkg	US32D	FBPART.1012	45.90
FB30B/50B Face Plate Pkg	BLK	FBPART.1093	45.90
FB30/50 Guide Pkg	-	FBPART.1013	8.50
FB30/40/50/60 Rub Plate & Shim Pkg	-	FBPART.1014	3.50
FB30/40/50B/60B Auxiliary Bolt	-	FBPART.1015	5.10
FB50T/60T Auxiliary Bolt	-	FBPART.1070	10.20
FB50T Rod & Bolt Tip Kit - 12"	-	FBPART.1071	15.20
FB50T Bolt Tip	-	FBPART.1072	8.50
FB30/50 8 3/4" Rod & Bolt Tip Kit - 12"	-	FBPART.1016	13.50
FB30/50B Bolt Tip	-	FBPART.1017	13.50
FB30/50 8 3/4" - 12" Rod Only	-	FBPART.1018	6.80

Contact Ives Customer Service for pricing on additional sizes and finishes

Bold pricing indicates item is in stock and available for **Fast Track** and **ProXpress**

IVES ARCHITECTURAL HARDWARE - Parts Price List

Description	Finish	Part No.	List Price Each
FB50 Series - Metal Door Constant Latching Flushbolt (Continued)			
FB30/50 7 1/2" Rod & Bolt Tip Kit - 9"	-	FBPART.1019	\$13.50
FB30/50 16 1/2" Rod & Bolt Tip Kit - 18"	-	FBPART.1020	13.50
FB30/50 22 1/2" Rod & Bolt Tip Kit - 24"	-	FBPART.1021	13.50
FB30/50 28 1/2" Rod & Bolt Tip Kit - 30"	-	FBPART.1022	13.50
FB30/50 34 1/2" Rod & Bolt Tip Kit - 36"	-	FBPART.1023	13.50
FB30/50 46 1/2" Rod & Bolt Tip Kit - 48"	-	FBPART.1024	13.50
FB30/40/50B/60B Strike Pkg	US3, US4	FBPART.1025	10.20
FB30/40/50B/60B Strike Pkg	US10	FBPART.1026	10.20
FB30/40/50B/60B Strike Pkg	US10B	FBPART.1027	10.20
FB30/40/50B/60B Strike Pkg	US32, US32D	FBPART.1028	10.20
FB30/40/50B/60B Strike Pkg	BLK	FBPART.1094	10.20
FB30/50 Mounting Pkg	US3, US4	FBPART.1029	24.10
FB30/50 Mounting Pkg	US10	FBPART.1030	24.10
FB30/50 Mounting Pkg	US10B	FBPART.1031	24.10
FB30/50 Mounting Pkg	US32, US32D	FBPART.1032	24.10
FB30/50 Mounting Pkg	BLK	FBPART.1095	24.10
FB30/50 Security Mounting Pkg	-	FBPART.1033	40.90
FB50T/60T Top Strike Pkg	US3	FBPART.1073	28.80
FB50T/60T Top Strike Pkg	US4	FBPART.1074	28.80
FB50T/60T Top Strike Pkg	US10	FBPART.1075	28.80
FB50T/60T Top Strike Pkg	US10B	FBPART.1076	28.80
FB50T/60T Top Strike Pkg	US32, US32D	FBPART.1077	28.80
FB50T/60T Top Strike Pkg	BLK	FBPART.1102	28.80
FB32/42/52/62 AFL Plug/Screw Pkg	-	FBPART.1034	6.00
FB32/42/52/62 Auxiliary Fire Latch	-	FBPART.1035	145.10
FB30/50 Retrofit Plate Pkg	-	FBPART.1065	11.50
FB30/40/50/60 Face Plate Screws. Pkg 10	US3, US4	FBPART.1066	7.50
FB30/40/50/60 Face Plate Screws. Pkg 10	US10	FBPART.1067	7.50
FB30/40/50/60 Face Plate Screws. Pkg 10	US10B	FBPART.1068	7.50
FB30/40/50/60 Face Plate Screws. Pkg 10	US32, US32D	FBPART.1069	7.50
FB30/40/50/60 Face Plate Screws. Pkg 10	BLK	FBPART.1101	7.50
FB60 Series - Wood Door Constant Latching Flushbolt			
FB60T Face Plate Pkg	US3	FBPART.1078	45.90
FB60T Face Plate Pkg	US4	FBPART.1079	45.90
FB60T Face Plate Pkg	US10	FBPART.1080	45.90
FB60T Face Plate Pkg	US10B	FBPART.1081	45.90
FB60T Face Plate Pkg	US32	FBPART.1082	45.90
FB60T Face Plate Pkg	US32D	FBPART.1083	45.90
FB60T Face Plate Pkg	BLK	FBPART.1103	45.90
FB40B/60B Face Plate Pkg	US3	FBPART.1042	45.90
FB40B/60B Face Plate Pkg	US4	FBPART.1043	45.90
FB40B/60B Face Plate Pkg	US10	FBPART.1044	45.90
FB40B/60B Face Plate Pkg	US10B	FBPART.1045	45.90
FB40B/60B Face Plate Pkg	US32	FBPART.1046	45.90
FB40B/60B Face Plate Pkg	US32D	FBPART.1047	45.90
FB40B/60B Face Plate Pkg	BLK	FBPART.1098	45.90
FB30/40/50/60 Rub Plate & Shim Pkg	-	FBPART.1014	3.50
FB40/60 Guide Pkg	-	FBPART.1048	10.20
FB40/60 Cover	-	FBPART.1049	6.80
FB30/40/50B/60B Auxiliary Bolt	-	FBPART.1015	5.10
FB50T/60T Auxiliary Bolt	-	FBPART.1070	10.20
FB60T Rod & Bolt Tip Kit	-	FBPART.1090	13.50
FB60T Bolt Tip	-	FBPART.1091	8.50

Contact Ives Customer Service for pricing on additional sizes and finishes

Bold pricing indicates item is in stock and available for **Fast Track** and **ProXpress**

IVES ARCHITECTURAL HARDWARE - Parts Price List

Description	Finish	Part No.	List Price Each
FB60 Series - Wood Door Constant Latching Flushbolt (Continued)			
FB40/60B Rod & Bolt Tip Kit	-	FBPART.1050	\$10.20
FB40/60B Bolt Tip	-	FBPART.1051	5.10
FB40/60 Rod - 2 1/2"	-	FBPART.1052	5.10
FB30/40/50B/60B Strike Pkg	US3, US4	FBPART.1025	10.20
FB30/40/50B/60B Strike Pkg	US10	FBPART.1026	10.20
FB30/40/50B/60B Strike Pkg	US10B	FBPART.1027	10.20
FB30/40/50B/60B Strike Pkg	US32, US32D	FBPART.1028	10.20
FB30/40/50B/60B Strike Pkg	BLK	FBPART.1094	10.20
FB40/60 Mounting Pkg	US3, US4	FBPART.1053	24.10
FB40/60 Mounting Pkg	US10	FBPART.1054	24.10
FB40/60 Mounting Pkg	US10B	FBPART.1055	24.10
FB40/60 Mounting Pkg	US32, US32D	FBPART.1056	24.10
FB40/60 Mounting Pkg	BLK	FBPART.1099	24.10
FB40/60 Security Mounting Pkg	-	FBPART.1057	37.60
FB50T/60T Top Strike Pkg	US3	FBPART.1073	28.80
FB50T/60T Top Strike Pkg	US4	FBPART.1074	28.80
FB50T/60T Top Strike Pkg	US10	FBPART.1075	28.80
FB50T/60T Top Strike Pkg	US10B	FBPART.1076	28.80
FB50T/60T Top Strike Pkg	US32, US32D	FBPART.1077	28.80
FB50T/60T Top Strike Pkg	BLK	FBPART.1102	28.80
FB32/42/52/62 AFL Plug/Screw Pkg	-	FBPART.1034	6.00
FB32/42/52/62 Auxiliary Fire Latch	-	FBPART.1035	145.10
FB30/40/50/60 Face Plate Screws. Pkg 10	US3, US4	FBPART.1066	7.50
FB30/40/50/60 Face Plate Screws. Pkg 10	US10	FBPART.1067	7.50
FB30/40/50/60 Face Plate Screws. Pkg 10	US10B	FBPART.1068	7.50
FB30/40/50/60 Face Plate Screws. Pkg 10	US32, US32D	FBPART.1069	7.50
FB30/40/50/60 Face Plate Screws. Pkg 10	BLK	FBPART.1101	7.50
FB457//FB458 Metal Door Manual Flushbolt			
Guide	-	09-135	2.60
Bolt Tip	-	09-176-604	5.90
Rod - 18"	-	09-161	7.10
Rod - 24"	-	09-162	7.10
Rod - 36"	-	09-172	7.10
Rod - 48"	-	09-173	7.10
FS9			
FS9 Hook Pkg	US3	FSPART.1001	59.70
FS9 Hook Pkg	US4	FSPART.1002	59.70
FS9 Hook Pkg	US10	FSPART.1003	59.70
FS9 Hook Pkg	US10B	FSPART.1004	51.30
FS9 Hook Pkg	US26	FSPART.1005	59.70
FS9 Hook Pkg	US26D	FSPART.1006	51.30
FS9 Mounting Pkg	US3, US4	FSPART.1007	6.80
FS9 Mounting Pkg	US10	FSPART.1008	6.80
FS9 Mounting Pkg	US10B	FSPART.1009	6.80
FS9 Mounting Pkg	US26, US26D	FSPART.1010	6.80
FS9 Security Mounting Pkg	-	FSPART.1011	10.20
FS9 Stud & Lead Anchor Pkg	-	FSPART.1012	10.20
FS13/FS17			
FS13/17 Rubber (Pkg of 6)	-	FSPART.1013	20.40
FS13/17 Mounting Pkg	US3, US4	FSPART.1014	3.50
FS13/17 Mounting Pkg	US10	FSPART.1015	3.50
FS13/17 Mounting Pkg	US10B	FSPART.1016	3.50
FS13/17 Mounting Pkg	US26, US26D	FSPART.1017	3.50

Contact Ives Customer Service for pricing on additional sizes and finishes

Bold pricing indicates item is in stock and available for **Fast Track** and **ProXpress**

IVES ARCHITECTURAL HARDWARE - Parts Price List

Description	Finish	Part No.	List Price Each
FS13/FS17 (Continued)			
FS13/17 Security Mounting Pkg	-	FSPART.1018	3.50
FS40/FS41/FS42/FS43			
FS40 Strike Pkg	US3	FSPART.1019	35.90
FS40 Strike Pkg	US4	FSPART.1020	34.20
FS40 Strike Pkg	US10	FSPART.1021	34.20
FS40 Strike Pkg	US10B	FSPART.1022	42.70
FS40 Strike Pkg	US26	FSPART.1023	35.90
FS40 Strike Pkg	US26D	FSPART.1024	34.20
FS41 Strike Pkg	US3	FSPART.1034	35.90
FS41 Strike Pkg	US4	FSPART.1035	34.20
FS41 Strike Pkg	US10	FSPART.1036	34.20
FS41 Strike Pkg	US10B	FSPART.1037	42.70
FS41 Strike Pkg	US26	FSPART.1038	35.90
FS41 Strike Pkg	US26D	FSPART.1039	34.20
FS42 Strike Pkg	US3	FSPART.1040	35.90
FS42 Strike Pkg	US4	FSPART.1041	34.20
FS42 Strike Pkg	US10	FSPART.1042	34.20
FS42 Strike Pkg	US10B	FSPART.1043	42.70
FS42 Strike Pkg	US26	FSPART.1044	35.90
FS42 Strike Pkg	US26D	FSPART.1045	34.20
FS43 Strike Pkg	US3	FSPART.1046	35.90
FS43 Strike Pkg	US4	FSPART.1047	34.20
FS43 Strike Pkg	US10	FSPART.1048	34.20
FS43 Strike Pkg	US10B	FSPART.1049	42.70
FS43 Strike Pkg	US26	FSPART.1050	35.90
FS43 Strike Pkg	US26D	FSPART.1051	34.20
FS40/41/42/43 Strike Mounting Pkg	US3, US4	FSPART.1025	6.80
FS40/41/42/43 Strike Mounting Pkg	US10	FSPART.1026	6.80
FS40/41/42/43 Strike Mounting Pkg	US10B	FSPART.1027	6.80
FS40/41/42/43 Strike Mounting Pkg	US26, US26D	FSPART.1028	6.80
FS40/41/42/43 Body Mounting Pkg	US3, US4	FSPART.1029	6.80
FS40/41/42/43 Body Mounting Pkg	US10	FSPART.1030	6.80
FS40/41/42/43 Body Mounting Pkg	US10B	FSPART.1031	6.80
FS40/41/42/43 Body Mounting Pkg	US26, US26D	FSPART.1032	6.80
FS40/41/42/43 Security Mounting Pkg	-	FSPART.1033	24.10
FS434			
FS434 Rubber	-	09-318	4.90
FS441			
FS441/442/451 Rubber	-	09-315	2.60
FS442			
FS441/442/451 Rubber	-	09-315	2.60
FS444/FS446/FS448/FS450			
Rubber Tip, order in quantities of 100	-	09-316	2.60
FS451			2.60
FS441/442/451 Rubber	-	09-315	
FS452			142.90
FS452/455	Rubber (Order in quantities of 100, Price per package of 100)	HRT (FSPART.1075)	
FS455			142.90
FS452/455	Rubber (Order in quantities of 100, Price per package of 100)	HRT (FSPART.1075)	
FS544/FS555			
FS544/555 Rubber - Threaded (Pkg of 6)	-	FSPART.1052	20.40

Contact Ives Customer Service for pricing on additional sizes and finishes

Bold pricing indicates item is in stock and available for **Fast Track** and **ProXpress**

IVES ARCHITECTURAL HARDWARE - Parts Price List

Description	Finish	Part No.	List Price Each
FS544/FS555 (continued)			
FS544/555 Mounting Pkg	SP4	FSPART.1054	\$5.10
FS544/555 Mounting Pkg	SP10	FSPART.1055	5.10
FS544/555 Mounting Pkg	SP313	FSPART.1056	5.10
FS544/555 Mounting Pkg	SP28	FSPART.1057	5.10
FS544/555 Mounting Pkg	SPBLK	FSPART.1058	5.10
FS544/555 Security Mounting Pkg	-	FSPART.1059	13.50
FS544/555 Rubber with Screw	-	FSPART.1074	3.50
FS1153			
FS1153 Rubber Pkg	-	FSPART.1060	3.50
FS1153 Mounting Pkg	US28	FSPART.1061	3.50
FS1153 Security Mounting Pkg	-	FSPART.1062	6.80
FS1154			
FS1154 Rubber Pkg	-	FSPART.1063	3.50
FS1154 Mounting Pkg	US3, US4	FSPART.1064	5.10
FS1154 Mounting Pkg	US10	FSPART.1065	5.10
FS1154 Mounting Pkg	US10B	FSPART.1066	5.10
FS1154 Mounting Pkg	US26, US26D	FSPART.1067	5.10
FS1154 Security Mounting Pkg	-	FSPART.1068	10.20
LGI			
LGI/7 Mounting Pkg	US32D, US2G	LGPART.1001	6.80
LGI/7 Mounting Pkg	USP	LGPART.1002	17.40
LGI/7 Mounting Pkg	US4	LGPART.1003	17.40
LGI/7 Mounting Pkg	US10	LGPART.1004	17.40
LGI/7 Mounting Pkg	SP313	LGPART.1005	17.40
LG7			
LGI/7 Mounting Pkg	US32D	LGPART.1001	6.80
LG10			
LG10/12/14 Mounting Pkg	US32D, USP	LGPART.1007	5.10
LG10/12/14 Security Mounting Pkg	-	LGPART.1008	13.50
LG11			
LG11/13 Mounting Pkg	US32D, SP313	LGPART.1009	5.10
LG11/13 Security Mounting Pkg	-	LGPART.1010	6.80
LG12			
LG10/12/14 Mounting Pkg	US32D, USP	LGPART.1007	5.10
LG10/12/14 Security Mounting Pkg	-	LGPART.1008	13.50
LG13			
LG11/13 Mounting Pkg	US32D, SP313	LGPART.1009	5.10
LG11/13 Security Mounting Pkg	-	LGPART.1010	6.80
LG14			
LG10/12/14 Mounting Pkg	US32D	LGPART.1007	5.10
LG10/12/14 Security Mounting Pkg	-	LGPART.1008	13.50
MB1F/MB2F/MB3F/MB1V/MB2V/MB3V			
MB1/2 AL Mounting Pkg	SPBLK	MBPART.1006	13.50
MB1/2 AL Security Mounting Pkg	-	MBPART.1007	13.50
MB1F/2F/3F/1V/2V/3V STL Mounting Pkg	SP28, USP	MBPART.1011	13.50
MB1F/2F/3F/1V/2V/3V STL Mounting Pkg	SPBLK	MBPART.1013	13.50
MB1F/2F/3F/1V/2V/3V STL Security Mtg Pkg	-	MBPART.1014	13.50
RB470/RB471/RB472			
RB470/471/472 Roller, Bushing & Rivet Pkg	US15, US26D	09-137-626	6.80
RL30			
RL30 Standard Strike Mtg Pkg	US3, US4	RLPART.1001	6.80
RL30 Standard Strike Mtg Pkg	US10	RLPART.1002	6.80

Contact Ives Customer Service for pricing on additional sizes and finishes

 Bold pricing indicates item is in stock and available for **Fast Track** and **ProXpress**

IVES ARCHITECTURAL HARDWARE - Parts Price List

Description	Finish	Part No.	List Price Each
RL30 (Continued)			
RL30 Standard Strike Mtg Pkg	US10B	RLPART.1003	\$6.80
RL30 Standard Strike Mtg Pkg	US26, US26D	RLPART.1004	6.80
RL30 ASA Strike Mtg Pkg	US3, US4	RLPART.1005	10.20
RL30 ASA Strike Mtg Pkg	US10	RLPART.1006	10.20
RL30 ASA Strike Mtg Pkg	US10B	RLPART.1007	10.20
RL30 ASA Strike Mtg Pkg	US26, US26D	RLPART.1008	10.20
RL30 Standard Strike Security Mtg Pkg	-	RLPART.1009	13.50
RL30 ASA Strike Security Mtg Pkg	-	RLPART.1010	13.50
RL30 Strike Pkg	US3	RLPART.1011	20.40
RL30 Strike Pkg	US4	RLPART.1012	20.40
RL30 Strike Pkg	US10	RLPART.1013	20.40
RL30 Strike Pkg	US10B	RLPART.1014	20.40
RL30 Strike Pkg	US26	RLPART.1015	20.40
RL30 Strike Pkg	US26D	RLPART.1016	20.40
RL30/32/36 ASA Strike Pkg	US3	RLPART.1017	20.40
RL30/32/36 ASA Strike Pkg	US4	RLPART.1018	20.40
RL30/32/36 ASA Strike Pkg	US10	RLPART.1019	20.40
RL30/32/36 ASA Strike Pkg	US10B	RLPART.1020	20.40
RL30/32/36 ASA Strike Pkg	US26	RLPART.1021	20.40
RL30/32/36 ASA Strike Pkg	US26D	RLPART.1022	20.40
RL30/1152 Rubber Roller, Silencers & Pin Pkg	-	RLPART.1023	13.50
RL30/1152 Nylon Coated Brass Roller & Pin Pkg	-	RLPART.1024	13.50
RL30/1152 Nylon Roller & Pin Pkg	-	RLPART.1025	11.90
RL30/1152 Roller Pin	-	RLPART.1026	3.50
RL30/1152 Nylon Silencers (Pkg of 2)	-	RLPART.1027	1.50
RL32			
RL32/36 Standard Strike Mtg Pkg	US3, US4	RLPART.1028	6.80
RL32/36 Standard Strike Mtg Pkg	US10	RLPART.1029	6.80
RL32/36 Standard Strike Mtg Pkg	US10B	RLPART.1030	6.80
RL32/36 Standard Strike Mtg Pkg	US32, US32D	RLPART.1031	6.80
RL32/36 ASA Strike Mtg Pkg	US3, US4	RLPART.1032	10.20
RL32/36 ASA Strike Mtg Pkg	US10	RLPART.1033	10.20
RL32/36 ASA Strike Mtg Pkg	US10B	RLPART.1034	10.20
RL32/36 ASA Strike Mtg Pkg	US32, US32D	RLPART.1035	10.20
RL32/36 Standard Strike Security Mtg Pkg	-	RLPART.1036	13.50
RL32/36 ASA Strike Security Mtg Pkg	-	RLPART.1037	13.50
RL32/36 Strike Pkg	US3	RLPART.1038	20.40
RL32/36 Strike Pkg	US4	RLPART.1039	20.40
RL32/36 Strike Pkg	US10	RLPART.1040	20.40
RL32/36 Strike Pkg	US10B	RLPART.1041	20.40
RL32/36 Strike Pkg	US32	RLPART.1042	20.40
RL32/36 Strike Pkg	US32D	RLPART.1043	20.40
RL30/32/36 ASA Strike Pkg	US3	RLPART.1017	20.40
RL30/32/36 ASA Strike Pkg	US4	RLPART.1018	20.40
RL30/32/36 ASA Strike Pkg	US10	RLPART.1019	20.40
RL30/32/36 ASA Strike Pkg	US10B	RLPART.1020	20.40
RL30/32/36 ASA Strike Pkg	US26	RLPART.1021	20.40
RL30/32/36 ASA Strike Pkg	US26D	RLPART.1022	20.40
RL32 Nylon Roller & Pin Pkg	-	RLPART.1045	11.90
RL32 Roller Pin	-	RLPART.1046	3.50
RL36			
RL32/36 Standard Strike Mtg Pkg	US32D	RLPART.1031	6.80
RL32/36 ASA Strike Mtg Pkg	US32D	RLPART.1035	10.20

Contact Ives Customer Service for pricing on additional sizes and finishes

Bold pricing indicates item is in stock and available for **Fast Track** and **ProXpress**

IVES ARCHITECTURAL HARDWARE - Parts Price List

Description	Finish	Part No.	List Price Each
RL36 (Continued)			
RL32/36 Standard Strike Security Mtg Pkg	-	RLPART.1036	\$13.50
RL32/36 ASA Strike Security Mtg Pkg	-	RLPART.1037	13.50
RL32/36 Strike Pkg	US32D	RLPART.1043	20.40
RL30/32/36 ASA Strike Pkg	US26D	RLPART.1022	20.40
RL38			
RL38 Mounting Pkg	US32D	RLPART.1051	6.80
RL38 Security Mtg Pkg	-	RLPART.1053	13.50
RL1152			
RL1152 Mounting Pkg	US3, US4	RLPART.1054	6.80
RL1152 Mounting Pkg	US10	RLPART.1055	6.80
RL1152 Mounting Pkg	US10B	RLPART.1056	6.80
RL1152 Mounting Pkg	US26, US26D	RLPART.1057	6.80
RL1152 Security Mounting Pkg	-	RLPART.1058	13.50
RL1152 Strike Pkg	US3	RLPART.1059	20.40
RL1152 Strike Pkg	US4	RLPART.1060	20.40
RL1152 Strike Pkg	US10	RLPART.1061	20.40
RL1152 Strike Pkg	US10B	RLPART.1062	20.40
RL1152 Strike Pkg	US26	RLPART.1063	20.40
RL1152 Strike Pkg	US26D	RLPART.1064	20.40
RL30/1152 Rubber Roller, Silencers & Pin Pkg	-	RLPART.1023	13.50
RL30/1152 Brass Roller & Pin Pkg	-	RLPART.1024	13.50
RL30/1152 Nylon Roller & Pin Pkg	-	RLPART.1025	11.90
RL30/1152 Roller Pin	-	RLPART.1026	3.50
RL30/1152 Nylon Silencers (Pkg of 2)	-	RLPART.1027	1.50
SB360			
SB360 Mortise Strike Pkg	US2C	09-82-604	28.40
SB360 Sex Bolt Package (Set of 4)	US2C	09-350-604	23.30
SB453			
Thru Bolt with Cap Nut Pkg (Set of 4)	US26D, US2C	09-340-626	9.90
Sex Bolt Pkg	US26D, US2C	09-351-604	18.20
SB1630/SB1640/SB1600M1/SB1600M2			
SB1600 Top Strike Pkg	US2G	SBPART.1001	18.70
SB1600 Top Strike Pkg	US3	SBPART.1002	32.30
SB1600 Top Strike Pkg	US10B, SP313	SBPART.1003	32.30
SB1600 Top Strike Pkg	US26D, SP28	SBPART.1004	22.20
SB1600 Top Strike Pkg	SP4	SBPART.1015	32.30
SB1600 Top Strike Pkg	SP10	SBPART.1016	32.30
SB1600 Top Strike Pkg	SPBLK	SBPART.1019	32.30
SB1600 Bottom Strike Pkg	US2G	SBPART.1005	13.50
SB1600 Bottom Strike Pkg	US3	SBPART.1006	27.60
SB1600 Bottom Strike Pkg	US10B, SP313	SBPART.1007	27.60
SB1600 Bottom Strike Pkg	US26D, SP28	SBPART.1008	17.40
SB1600 Bottom Strike Pkg	SP4	SBPART.1020	27.60
SB1600 Bottom Strike Pkg	SP10	SBPART.1021	27.60
SB1600 Bottom Strike Pkg	SPBLK	SBPART.1024	27.60
SB1600 Bolt Mounting Pkg	-	SBPART.1009	6.80
SB1600 End Plug & Stud Pkg	-	SBPART.1010	10.20
SB1600 Security Mounting Pkg	-	SBPART.1011	13.50
SB1600 Lock Housing Pkg	US2G	SBPART.1033	25.60
SB1600 Lock Housing Pkg	US3	SBPART.1034	42.70
SB1600 Lock Housing Pkg	US10B	SBPART.1035	42.70
SB1600 Lock Housing Pkg	US26D	SBPART.1036	34.20
SB1600 Lock Housing Pkg	SP4	SBPART.1017	42.70

Contact Ives Customer Service for pricing on additional sizes and finishes

Bold pricing indicates item is in stock and available for **Fast Track** and **ProXpress**

IVES ARCHITECTURAL HARDWARE - Parts Price List

Description	Finish	Part No.	List Price Each
SB1630/SB1640/SB1600M1/SB1600M2 (Continued)			
SB1600 Lock Housing Pkg	SP10	SBPART.1018	\$42.70
SB1600 Lock Housing Pkg	SP313	SBPART.1023	42.70
SB1600 Lock Housing Pkg	SP28	SBPART.1025	42.70
SB1600 Lock Housing Pkg	SPBLK	SBPART.1022	42.70
SB1600 Lock Cylinder - 1289	-	SBPART.1037	20.40
SB1600 Lock Cylinder - 1360	-	SBPART.1038	20.40
SB1600 Lock Cylinder - 1390	-	SBPART.1039	20.40
SB1600 Lock Cylinder - 1395	-	SBPART.1040	20.40
SB1600 Sex Bolt Pkg (Set of 3)	US26D, US2G,SP28	SBPART.1012	31.60
SB1600 Sex Bolt Pkg (Set of 3)	US3	SBPART.1013	31.60
SB1600 Sex Bolt Pkg (Set of 3)	US10B,SP313	SBPART.1014	31.60
SB1600 Sex Bolt Pkg (Set of 3)	SP4	SBPART.1028	31.60
SB1600 Sex Bolt Pkg (Set of 3)	SP10	SBPART.1029	31.60
SB1600 Sex Bolt Pkg (Set of 3)	SPBLK	SBPART.1032	31.60
SR64			
SR64 Installation Pin	-	SRPART.1001	1.50
SR64 Installation Pin (Pkg of 10)	-	SRPART.1002	17.40
VR900/VR904/VR900-LLP/VR904-LLP			
VR900 Mounting Pkg	US32D	VRPART.1001	10.20
VR900/910/910M Collar Pkg	US32D	VRPART.1002	34.20
VR910DT/VR914DT/VR810DT/VR814DT			
VR910/910M Mounting Pkg	US32D	VRPART.1003	10.20
VR910DT/VR914DT/VR810NL/VR814NL			
VR910/910M Mounting Pkg	US32D	VRPART.1003	10.20
VR910/910 Cylinder Mounting Pkg	US32D	VRPART.1004	22.20
VR900/910/910M Collar Pkg	US32D	VRPART.1002	34.20
VR910M-DT/ VR914-DT			
VR910/910M Mounting Pkg	US32D	VRPART.1003	10.20
VR910M-NL / VR914M-NL			
VR910/910M Mounting Pkg	US32D	VRPART.1003	10.20
VR900/910/910M Collar Pkg	US32D	VRPART.1002	34.20
WS11			
WS11/11X/20/33 Rubber (Pkg of 6)	-	WSPART.1001	20.40
WS11/33 Mounting Pkg	US3, US4	WSPART.1002	5.10
WS11/33 Mounting Pkg	US10	WSPART.1003	5.10
WS11/33 Mounting Pkg	US10B	WSPART.1004	5.10
WS11/33 Mounting Pkg	US26, US26D	WSPART.1005	5.10
WS11/33 Security Mounting Pkg	-	WSPART.1006	13.50
WS11X			
WS11/11X/20/33 Rubber (Pkg of 6)	-	WSPART.1001	20.40
WS11X/33X Mounting Pkg	US3, US4	WSPART.1029	8.50
WS11X/33X Mounting Pkg	US10	WSPART.1030	8.50
WS11X/33X Mounting Pkg	US10B	WSPART.1031	8.50
WS11X/33X Mounting Pkg	US26, US26D	WSPART.1032	8.50
WS11X/33X Security Mounting Pkg	-	WSPART.1033	11.90
WS20			
WS11/11X/20/33 Rubber (Pkg of 6)	-	WSPART.1001	20.40
WS20/20X Strike Pkg	US3	WSPART.1008	17.40
WS20/20X Strike Pkg	US4	WSPART.1009	17.40
WS20/20X Strike Pkg	US10	WSPART.1010	17.40
WS20/20X Strike Pkg	US10B	WSPART.1011	17.40
WS20/20X Strike Pkg	US26	WSPART.1012	17.40
WS20/20X Strike Pkg	US26D	WSPART.1013	17.40
WS20 Mounting Pkg	US3, US4	WSPART.1014	8.50

Contact Ives Customer Service for pricing on additional sizes and finishes

Bold pricing indicates item is in stock and available for **Fast Track** and **ProXpress**

IVES ARCHITECTURAL HARDWARE - Parts Price List

Description	Finish	Part No.	List Price Each
WS20 (Continued)			
WS20 Mounting Pkg	US10	WSPART.1015	\$8.50
WS20 Mounting Pkg	US10B	WSPART.1016	8.50
WS20 Mounting Pkg	US26, US26D	WSPART.1017	8.50
WS20 Security Mounting Pkg	-	WSPART.1018	17.40
WS20X			
WS11/11X/20/33 Rubber (Pkg of 6)	-	WSPART.1001	20.40
WS20/20X Strike Pkg	US3	WSPART.1008	17.40
WS20/20X Strike Pkg	US4	WSPART.1009	17.40
WS20/20X Strike Pkg	US10	WSPART.1010	17.40
WS20/20X Strike Pkg	US10B	WSPART.1011	17.40
WS20/20X Strike Pkg	US26	WSPART.1012	17.40
WS20/20X Strike Pkg	US26D	WSPART.1013	17.40
WS20X Mounting Pkg	US3, US4	WSPART.1019	13.50
WS20X Mounting Pkg	US10	WSPART.1020	13.50
WS20X Mounting Pkg	US10B	WSPART.1021	13.50
WS20X Mounting Pkg	US26, US26D	WSPART.1022	13.50
WS20X Security Mounting Pkg	-	WSPART.1023	20.40
WS33			
WS11/11X/20/33 Rubber (Pkg of 6)	-	WSPART.1001	20.40
WS11/33 Mounting Pkg	US3, US4	WSPART.1002	5.10
WS11/33 Mounting Pkg	US10	WSPART.1003	5.10
WS11/33 Mounting Pkg	US10B	WSPART.1004	5.10
WS11/33 Mounting Pkg	US26, US26D	WSPART.1005	5.10
WS11/33 Security Mounting Pkg	-	WSPART.1006	13.50
WS33X			
WS11/11X/20/33 Rubber (Pkg of 6)	-	WSPART.1001	20.40
WS11X/33X Mounting Pkg	US3, US4	WSPART.1029	8.50
WS11X/33X Mounting Pkg	US10	WSPART.1030	8.50
WS11X/33X Mounting Pkg	US10B	WSPART.1031	8.50
WS11X/33X Mounting Pkg	US26, US26D	WSPART.1032	8.50
WS11X/33X Security Mounting Pkg	-	WSPART.1033	11.90
WS40			
WS40 Hook Pkg	US3	WSPART.1034	18.70
WS40 Hook Pkg	US4	WSPART.1035	17.40
WS40 Hook Pkg	US10	WSPART.1036	17.40
WS40 Hook Pkg	US10B	WSPART.1037	17.40
WS40 Hook Pkg	US26	WSPART.1038	18.70
WS40 Hook Pkg	US26D	WSPART.1039	17.40
WS40 Hook Pkg	US28	WSPART.1040	15.20
WS40 Mounting Pkg	US3, US4	WSPART.1041	10.20
WS40 Mounting Pkg	US10	WSPART.1042	10.20
WS40 Mounting Pkg	US10B	WSPART.1043	10.20
WS40 Mounting Pkg	US26, US26D, US28	WSPART.1044	10.20
WS40 Security Mounting Pkg	-	WSPART.1045	20.40
WS45			
WS45 Hook Pkg	US3	WSPART.1046	90.30
WS45 Hook Pkg	US4	WSPART.1047	85.30
WS45 Hook Pkg	US10	WSPART.1048	85.30
WS45 Hook Pkg	US10B	WSPART.1049	85.30
WS45 Hook Pkg	US26	WSPART.1050	90.30
WS45 Hook Pkg	US26D	WSPART.1051	88.60
WS45 Mounting Pkg	US3, US4	WSPART.1052	10.20

Contact Ives Customer Service for pricing on additional sizes and finishes

Bold pricing indicates item is in stock and available for **Fast Track** and **ProXpress**

IVES ARCHITECTURAL HARDWARE - Parts Price List

Description	Finish	Part No.	List Price Each
WS45 (Continued)			
WS45 Mounting Pkg	US10	WSPART.1053	\$10.20
WS45 Mounting Pkg	US10B	WSPART.1054	10.20
WS45 Mounting Pkg	US26, US26D	WSPART.1055	10.20
WS45 Security Mounting Pkg	-	WSPART.1056	25.60
WS45X			
WS45X Hook Pkg	US3	WSPART.1057	95.50
WS45X Hook Pkg	US4	WSPART.1058	88.60
WS45X Hook Pkg	US10	WSPART.1059	88.60
WS45X Hook Pkg	US10B	WSPART.1060	88.60
WS45X Hook Pkg	US26	WSPART.1061	95.50
WS45X Hook Pkg	US26D	WSPART.1062	95.50
WS45X Mounting Pkg	US3, US4	WSPART.1063	17.40
WS45X Mounting Pkg	US10	WSPART.1064	17.40
WS45X Mounting Pkg	US10B	WSPART.1065	17.40
WS45X Mounting Pkg	US26, US26D	WSPART.1066	17.40
WS45X Security Mounting Pkg	-	WSPART.1067	25.60
WS65			
60-65/70/430	RT Rubber, order in quantities of 100 (Price per package of 100)	RT (WSPART.1075)	97.00
60-65/70/430	Black Rubber Tip, order in quantities of 100 (Price per package of 100)	WSPART.1089	97.00
WS436/WS438			
FS13/17 Security Mounting Pkg	-	FSPART.1018	3.50
WS443			
Rubber Tip, order in quantities of 100	-	09-316	2.60
WS445			
Rubber Tip, order in quantities of 100	-	09-316	2.60
WS447			
Rubber Tip, order in quantities of 100	-	09-316	2.60
WS449			
Rubber Tip, order in quantities of 100	-	09-316	2.60
S48			
S48/262/265/266 Strike Pkg	B3	09-40-605	6.10
S48/262/265/266 Strike Pkg	B10B	09-40-613	6.10
S48/262/265/266 Strike Pkg	B26D	09-40-626	6.10
54			
054/253 Mortise Strike Pkg	B3	09-22-605	10.00
054/253 Mortise Strike Pkg	B10B	09-22-613	10.00
054/253 Mortise Strike Pkg	B26D	09-22-626	10.00
060/061			
060/061	SRT Rubber, order in quantities of 100 (Price per package of 100)	SRT (WSPART.1076)	45.30
60			
60-65/70/430	RT Rubber, order in quantities of 100 (Price per package of 100)	RT (WSPART.1075)	97.00
60-65/70/430	Black Rubber Tip, order in quantities of 100 (Price per package of 100)	WSPART.1089	97.00
61			
60-65/70/430	RT Rubber, order in quantities of 100 (Price per package of 100)	RT (WSPART.1075)	97.00
60-65/70/430	Black Rubber Tip, order in quantities of 100 (Price per package of 100)	WSPART.1089	97.00
62			

Contact Ives Customer Service for pricing on additional sizes and finishes

Bold pricing indicates item is in stock and available for **Fast Track** and **ProXpress**

IVES ARCHITECTURAL HARDWARE - Parts Price List

Description	Finish	Part No.	List Price Each
60-65/70/430	RT Rubber, order in quantities of 100 (Price per package of 100)	RT (WSPART.1075)	\$97.00
60-65/70/430	Black Rubber Tip, order in quantities of 100 (Price per package of 100)	WSPART.1089	97.00
64			
60-65/70/430	RT Rubber, order in quantities of 100 (Price per package of 100)	RT (WSPART.1075)	97.00
60-65/70/430	Black Rubber Tip, order in quantities of 100 (Price per package of 100)	WSPART.1089	97.00
69			
69 Rubber Tip	(Price per package of 100)	09-310	90.50
70			
60-65/70/430	RT Rubber, order in quantities of 100 (Price per package of 100)	RT (WSPART.1075)	97.00
60-65/70/430	Black Rubber Tip, order in quantities of 100 (Price per package of 100)	WSPART.1089	97.00
72/73			
60-65/70/430	RT Rubber, order in quantities of 100 (Price per package of 100)	RT (WSPART.1075)	97.00
60-65/70/430	Black Rubber Tip, order in quantities of 100 (Price per package of 100)	WSPART.1089	97.00
253			
Angle Strike Pkg	B3	09-33-605	22.30
Angle Strike Pkg	B10B	09-33-613	22.30
Angle Strike Pkg	B26D	09-33-626	22.30
Mortise Strike Pkg	B3	09-22-605	10.00
Mortise Strike Pkg	B10B	09-22-613	10.00
Mortise Strike Pkg	B26D	09-22-626	10.00
262			
S48/262/265 Strike Pkg	B3	09-40-605	6.10
S48/262/265 Strike Pkg	B10B	09-40-613	6.10
S48/262/265 Strike Pkg	B26D	09-40-626	6.10
265			
S48/262/265 Strike Pkg	B3	09-40-605	6.10
S48/262/265 Strike Pkg	B10B	09-40-613	6.10
S48/262/265 Strike Pkg	B26D	09-40-626	6.10
335			
335 Strike & Mounting Pkg	B10B	09-45-613	7.50
335 Strike & Mounting Pkg	B15	09-45-619	7.50
336			
336 Strike & Mounting Pkg	B3	09-47-605	8.10
336 Strike & Mounting Pkg	B10B	09-47-613	8.10
336 Strike & Mounting Pkg	B26D	09-47-626	8.10
347			
347 Strike & Mounting Pkg	B3	09-53-605	7.50
347 Strike & Mounting Pkg	B10B	09-53-613	7.50
347 Strike & Mounting Pkg	B15	09-53-619	7.50
347 Strike & Mounting Pkg	B26	09-53-625	7.50
347 Strike & Mounting Pkg	B26D	09-53-626	7.50
349			
349 Strike & Mounting Pkg	B3	09-61-605	7.50
349 Strike & Mounting Pkg	B10B	09-61-613	7.50
349 Strike & Mounting Pkg	B26D	09-61-626	7.50
353/354 Angle Strike Pkg	B26D	09-33-626	22.30
353/354 Mortise Strike Pkg	B3	09-22-605	10.00
353/354 Mortise Strike Pkg	B10B	09-22-613	10.00
353/354 Mortise Strike Pkg	B26D	09-22-626	10.00
430			

Contact Ives Customer Service for pricing on additional sizes and finishes

Bold pricing indicates item is in stock and available for **Fast Track** and **ProXpress**

IVES ARCHITECTURAL HARDWARE - Parts Price List

Description	Finish	Part No.	List Price Each
60-65/70/430	RT Rubber, order in quantities of 100 (Price per package of 100)	RT (WSPART.1075)	\$97.00
60-65/70/430	Black Rubber Tip, order in quantities of 100 (Price per package of 100)	WSPART.1089	97.00
482			
482 Plate	B3	09-170-605	8.10
482 Plate	B10B	09-170-613	8.10
482 Plate	B15, B26D	09-170-626	8.10
482 SHIM 1/8 IN	B15, B26D	09-576-626	18.50
482 SHIM 3/8 IN	B15, B26D	09-577-626	29.30
620			
Sex Bolt Package (Set of 4)	B3, B-505	09-355-605	12.80
Sex Bolt Package (Set of 4)	B10B, B-613	09-355-613	15.40
Sex Bolt Package (Set of 4)	B15, B-619, B15A, B-620	09-355-626	15.40
621			
Sex Bolt Package (Set of 4)	B3	09-355-605	12.80
Sex Bolt Package (Set of 4)	B10B	09-355-613	15.40
Sex Bolt Package (Set of 4)	B15, B15A, B26, B26D, PA28	09-355-626	15.40
U696			
696-700-701 Viewer Cover	606	890312606	2.20
696-700-701 Viewer Cover	613	890312613	2.20
696-700-701 Viewer Cover	619	890312619	2.20
696-700-701 Viewer Cover	625	890312625	2.20
696-700-701 Viewer Cover	626	890312626	2.20
696-700-701 Viewer Cover	716	890312716	2.20
696-700-701 Viewer Cover	622	890312622	2.20
696-700-701 Viewer Extension	626	890314626	3.30
View Trim Washer	B4	09-241-606	0.30
View Trim Washer	B26D	09-241-626	0.30
U698			
698 Viewer Cover	605	890311605	2.80
698 Viewer Cover	619	890311619	2.80
698 Viewer Cover	625	890311625	2.80
698 Viewer Cover	626	890311626	2.80
698 Viewer Cover	716	890311716	2.80
698 Viewer Cover	622	890311622	2.80
698 Viewer Extension	626	890313626	4.50
700			
696-700-701 Viewer Cover	606	890312606	2.20
696-700-701 Viewer Cover	613	890312613	2.20
696-700-701 Viewer Cover	619	890312619	2.20
696-700-701 Viewer Cover	625	890312625	2.20
696-700-701 Viewer Cover	626	890312626	2.20
696-700-701 Viewer Cover	716	890312716	2.20
696-700-701 Viewer Cover	622	890312622	2.20
696-700-701 Viewer Extension	626	890314626	3.30
View Trim Washer	B4	09-241-606	0.30
View Trim Washer	B10B	09-241-613	0.30
View Trim Washer	B26D	09-241-626	0.30
701			
696-700-701 Viewer Cover	606	890312606	2.20
696-700-701 Viewer Cover	613	890312613	2.20
696-700-701 Viewer Cover	619	890312619	2.20
696-700-701 Viewer Cover	625	890312625	2.20
696-700-701 Viewer Cover	626	890312626	2.20
696-700-701 Viewer Cover	716	890312716	2.20
696-700-701 Viewer Cover	622	890312622	2.20
696-700-701 Viewer Extension	626	890314626	3.30
View Trim Washer	B4	09-241-606	0.30
View Trim Washer	B10B	09-241-613	0.30
View Trim Washer	B26D	09-241-626	0.30

Contact Ives Customer Service for pricing on additional sizes and finishes

Bold pricing indicates item is in stock and available for **Fast Track** and **ProXpress**

IVES ARCHITECTURAL HARDWARE - Parts Price List

Description	Finish	Part No.	List Price Each
8112			
Screw - #8 x 1" OPHSMS (Qty 6)	B26D	PULLPART.1060	\$3.60
8121 (1 3/4" Door)			
Screw - #8 x 1" OPHSMS (Qty 6)	B26D	PULLPART.1060	3.60
8121 Screw Pkg - K Mount	B26D	09-512-618	31.10
8200/8300/8302/8303/8305/8311/8400 Plate Mounting Screws			
Gasket	-	KPPART.10013	24.00
Screw - #6 x 5/8" UOPHSMS (Pkg 16)	B3, B4	09-282-632	0.50
Screw - #6 x 5/8" UOPHSMS (Pkg 16)	B10	09-282-639	0.50
Screw - #6 x 5/8" UOPHSMS (Pkg 16)	B10B, B-613, BRN	09-282-640	0.50
Screw - #6 x 5/8" UOPHSMS (Pkg 16)	B15, B26, B26D, S32, S32D, PA28, CLR	09-282-630	0.50
Screw - #6 x 5/8" TEK/TORX SMS (Pkg 16)	B3, B4	KPPART.10014	13.40
Screw - #6 x 5/8" TEK/TORX SMS (Pkg 16)	B10	KPPART.10015	13.40
Screw - #6 x 5/8" TEK/TORX SMS (Pkg 16)	B10B, B-613, BRN	KPPART.10016	13.40
Screw - #6 x 5/8" TEK/TORX SMS (Pkg 16)	B15, B26, B26D, S32, S32D, PA	KPPART.10017	13.40
Pull Mounting Packages for 8105, 8111, 8305, 8311, 8700, 8800			
Also used with Old Mtg Style Pulls (Non-HD) 8102, 8103, 8103EZ, 8190, 8302, 8303, 9100			
See Page 68 for which options can be used with each model.			
Standard Mount 1.3/4" Door	B3, B4	09-469-605	6.70
Standard Mount 1.3/4" Door	B10	09-469-612	6.70
Standard Mount 1.3/4" Door	B10B	09-469-613	6.70
Standard Mount 1.3/4" Door	B15, B26, B26D, PA28, S32, S32D	09-469-603	6.70
Standard Mount 2" Door	B3, B4	PULLPART.1001	6.70
Standard Mount 2" Door	B10	PULLPART.1002	6.70
Standard Mount 2" Door	B10B	PULLPART.1003	6.70
Standard Mount 2" Door	B15, B26, B26D, PA28, S32, S32D	PULLPART.1004	6.70
F Mount 1.3/4" Door	-	09-464-603	3.60
F Mount 2" Door	-	PULLPART.1005	3.60
F Mount 2 1/4" Door	-	PULLPART.1006	3.60
G Mount	-	09-509-603	3.60
H / I / L Mount (combined pack)	-	09-510-603	39.70
J / N Mount (combined pack) 1.3/4" Door	-	09-508-603	13.80
J / N Mount (combined pack) 2" - 2 1/4" Door	-	09-294-603	13.80
M Mount 1 3/4" - 2" Door	B3	09-521-605	26.40
M Mount 1 3/4" - 2" Door	B4	09-521-606	26.40
M Mount 1 3/4" - 2" Door	B10	09-521-612	26.40
M Mount 1 3/4" - 2" Door	B10B	09-521-613	26.40
M Mount 1 3/4" - 2" Door	B26	09-521-625	26.40
M Mount 1 3/4" - 2" Door	B26D	09-521-626	26.40
M Mount 1 3/4" - 2" Door	S32	09-521-629	26.40
M Mount 1 3/4" - 2" Door	S32D	09-521-630	26.40
M Mount 1 3/4" - 2" Door	B15	09-521-619	26.40
M Mount 2 1/4" Door	S32D	PULLPART.1007	54.00
M Mount 2 1/4" Door	B3	PULLPART.1008	54.00
M Mount 2 1/4" Door	B4	PULLPART.1009	54.00
M Mount 2 1/4" Door	B10	PULLPART.1010	54.00
M Mount 2 1/4" Door	B10B	PULLPART.1011	54.00
M Mount 2 1/4" Door	B26	PULLPART.1012	54.00
M Mount 2 1/4" Door	S32	PULLPART.1013	54.00
M Mount 2 1/4" Door	B26d	PULLPART.1014	54.00
M Mount 2 1/4" Door	B15	PULLPART.1015	54.00
O Mount 1.3/4" Door	B3	09-523-605	22.20
O Mount 1.3/4" Door	B4	09-523-606	22.20
O Mount 1.3/4" Door	B10	09-523-612	22.20
O Mount 1.3/4" Door	B10B	09-523-613	22.20
O Mount 1.3/4" Door	B26	09-523-625	22.20
O Mount 1.3/4" Door	B26D	09-523-626	22.20
O Mount 1.3/4" Door	S32	09-523-629	22.20
O Mount 1.3/4" Door	S32D	09-523-630	22.20
O Mount 1.3/4" Door	B15	09-523-619	22.20
O Mount 2" Door	S32D	PULLPART.1016	45.30
O Mount 2" Door	B3	PULLPART.1017	45.30
O Mount 2" Door	B4	PULLPART.1018	45.30

Contact Ives Customer Service for pricing on additional sizes and finishes

Bold pricing indicates item is in stock and available for **Fast Track** and **ProXpress**

IVES ARCHITECTURAL HARDWARE - Parts Price List

Description	Finish	Part No.	List Price Each
Pull Mounting Packages for 8105, 8111, 8305, 8311, 8700, 8800			
Also used with Old Mtg Style Pulls (Non-HD) 8102, 8103, 8103EZ, 8190, 8302, 8303, 9100 (Continued)			
See Page 68 for which options can be used with each model.			
O Mount 2" Door	B10	PULLPART.1019	\$45.30
O Mount 2" Door	B10B	PULLPART.1020	45.30
O Mount 2" Door	B26	PULLPART.1021	45.30
O Mount 2" Door	S32	PULLPART.1022	45.30
O Mount 2" Door	B26D	PULLPART.1023	45.30
O Mount 2" Door	B15	PULLPART.1024	45.30
O Mount 2 1/4" Door	S32D	PULLPART.1025	45.30
O Mount 2 1/4" Door	B3	PULLPART.1026	45.30
O Mount 2 1/4" Door	B4	PULLPART.1027	45.30
O Mount 2 1/4" Door	B10	PULLPART.1028	45.30
O Mount 2 1/4" Door	B10B	PULLPART.1029	45.30
O Mount 2 1/4" Door	B26	PULLPART.1030	45.30
O Mount 2 1/4" Door	S32	PULLPART.1031	45.30
O Mount 2 1/4" Door	B26D	PULLPART.1032	45.30
O Mount 2 1/4" Door	B15	PULLPART.1033	45.30
* Type M and O mounting packs are sold in multiples of 1.			
Pull HD Mounting Packages for 8102HD, 8302, 8372, 8373, 8975			
See Page 68 for which options can be used with each model.			
5/16HD Standard Mount 1.1/2"-1.7/8" Door	B15,B26,26D	PULLPART.1063	6.70
5/16HD Standard Mount 1.1/2"-1.7/8" Door	B3	PULLPART.1064	6.70
5/16HD Standard Mount 1.1/2"-1.7/8" Door	B10	PULLPART.1065	6.70
5/16HD Standard Mount 1.1/2"-1.7/8" Door	B10B	PULLPART.1066	6.70
5/16HD Standard Mount 2-2.1/4" Door	B15,B26,B26D	PULLPART.1071	6.70
5/16HD Standard Mount 2-2.1/4" Door	B3	PULLPART.1072	6.70
5/16HD Standard Mount 2-2.1/4" Door	B10	PULLPART.1073	6.70
5/16HD Standard Mount 2-2.1/4" Door	B10B	PULLPART.1074	6.70
5/16HD G Mount	-	PULLPART.1079	3.60
5/16HD I Mount	-	PULLPART.1081	39.70
5/16HD J Mount 1.1/2"-1.7/8" Door	-	PULLPART.1085	13.80
5/16HD J Mount 2-2.1/4" Door	-	PULLPART.1086	13.80
5/16HD L Mount	-	PULLPART.1083	39.70
Pull HD Mounting Packages for 8103HD, 8103EZHD, 8145EZHD, 8190HD, 8190EZHD, 8303, 9100HD, 9264, 9266, 8169, 8181, 8281, 8189, 8312, 8320, 8371, 8848			
See Page 68 for which options can be used with each model.			
3/8HD Standard Mount 1.1/2"-1.7/8" Door	B15,B26,26D	PULLPART.1067	6.70
3/8HD Standard Mount 1.1/2"-1.7/8" Door	B3	PULLPART.1068	6.70
3/8HD Standard Mount 1.1/2"-1.7/8" Door	B10	PULLPART.1069	6.70
3/8HD Standard Mount 1.1/2"-1.7/8" Door	B10B	PULLPART.1070	6.70
3/8HD Standard Mount 2-2.1/4" Door	B15,B26,B26D	PULLPART.1075	6.70
3/8HD Standard Mount 2-2.1/4" Door	B3,B4	PULLPART.1076	6.70
3/8HD Standard Mount 2-2.1/4" Door	B10	PULLPART.1077	6.70
3/8HD Standard Mount 2-2.1/4" Door	B10B	PULLPART.1078	6.70
3/8HD A Mount	-	PULLPART.1200	39.70
3/8HD G Mount	-	PULLPART.1080	3.60
3/8HD I Mount	-	PULLPART.1082	39.70
3/8HD L Mount	-	PULLPART.1084	20.20
3/8HD N Mount 1.1/2"-1.7/8" Door	-	PULLPART.1087	13.80
3/8HD N Mount 2-2.1/4" Door	-	PULLPART.1088	13.80
3/8HD O Mount 1.1/2"-1.7/8" Door	B3	PULLPART.1089	43.70
3/8HD O Mount 1.1/2"-1.7/8" Door	US4	PULLPART.1090	43.70
3/8HD O Mount 1.1/2"-1.7/8" Door	US10	PULLPART.1091	43.70
3/8HD O Mount 1.1/2"-1.7/8" Door	US10B	PULLPART.1092	43.70
3/8HD O Mount 1.1/2"-1.7/8" Door	US15	PULLPART.1093	43.70
3/8HD O Mount 1.1/2"-1.7/8" Door	US26	PULLPART.1094	43.70

Contact Ives Customer Service for pricing on additional sizes and finishes

Bold pricing indicates item is in stock and available for **Fast Track** and **ProXpress**

IVES ARCHITECTURAL HARDWARE - Parts Price List

Description	Finish	Part No.	List Price Each
Pull HD Mounting Packages for 8103HD, 8103EZHD, 8145EZHD, 8190HD, 8190EZHD, 8303, 9100HD, 9264, 9266, 8169, 8181, 8281, 8189, 8312, 8320, 8371, 8848 (Continued) See Page 68 for which options can be used with each model.			
3/8HD O Mount 1.1/2"-1.7/8" Door	US26D	PULLPART.1095	\$43.70
3/8HD O Mount 1.1/2"-1.7/8" Door	US32	PULLPART.1096	43.70
3/8HD O Mount 1.1/2"-1.7/8" Door	US32D	PULLPART.1097	43.70
3/8HD O Mount 2-2.1/4" Door	US3	PULLPART.1098	45.40
3/8HD O Mount 2-2.1/4" Door	US4	PULLPART.1099	45.40
3/8HD O Mount 2-2.1/4" Door	US10	PULLPART.1100	45.40
3/8HD O Mount 2-2.1/4" Door	US10B	PULLPART.1101	45.40
3/8HD O Mount 2-2.1/4" Door	US15	PULLPART.1102	45.40
3/8HD O Mount 2-2.1/4" Door	US26	PULLPART.1103	45.40
3/8HD O Mount 2-2.1/4" Door	US26D	PULLPART.1104	45.40
3/8HD O Mount 2-2.1/4" Door	US32	PULLPART.1105	45.40
3/8HD O Mount 2-2.1/4" Door	US32D	PULLPART.1106	45.40
3/8HD P Mount	-	PULLPART.1201	49.20
3/8HD Q Mount 3/8"-5/8" Door	B3	PULLPART.1202	58.70
3/8HD Q Mount 3/8"-5/8" Door	US4	PULLPART.1203	58.70
3/8HD Q Mount 3/8"-5/8" Door	US10	PULLPART.1204	58.70
3/8HD Q Mount 3/8"-5/8" Door	US10B	PULLPART.1205	58.70
3/8HD Q Mount 3/8"-5/8" Door	US15	PULLPART.1206	58.70
3/8HD Q Mount 3/8"-5/8" Door	US26	PULLPART.1207	58.70
3/8HD Q Mount 3/8"-5/8" Door	US26D	PULLPART.1208	58.70
3/8HD Q Mount 3/8"-5/8" Door	US32	PULLPART.1209	58.70
3/8HD Q Mount 3/8"-5/8" Door	US32D	PULLPART.1210	58.70
3/8HD X Mount 1.1/2"-1.7/8" Door	B15,B26,26D	PULLPART.1211	45.40
3/8HD X Mount 1.1/2"-1.7/8" Door	B3	PULLPART.1212	45.40
3/8HD X Mount 1.1/2"-1.7/8" Door	B10	PULLPART.1213	45.40
3/8HD X Mount 1.1/2"-1.7/8" Door	B10B	PULLPART.1214	45.40
3/8HD X Mount 2-2.1/4" Door	B15,B26,B26D	PULLPART.1215	45.40
3/8HD X Mount 2-2.1/4" Door	B3,B4	PULLPART.1216	45.40
3/8HD X Mount 2-2.1/4" Door	B10	PULLPART.1217	45.40
3/8HD X Mount 2-2.1/4" Door	B10B	PULLPART.1218	45.40
Old Mtg Style Push/Pull Combos (Non-HD) Mounting Packages for 9103EZ, 9190 See Page 68 for which options can be used with each model.			
NO Mount 1.3/4" Door	B3	09-525-605	55.50
NO Mount 1.3/4" Door	B4	09-525-606	55.50
NO Mount 1.3/4" Door	B10	09-525-612	55.50
NO Mount 1.3/4" Door	B10B	09-525-613	55.50
NO Mount 1.3/4" Door	B26	09-525-625	55.50
NO Mount 1.3/4" Door	B26D	09-525-626	55.50
NO Mount 1.3/4" Door	S32	09-525-629	55.50
NO Mount 1.3/4" Door	S32D	09-525-630	55.50
NO Mount 1.3/4" Door	B15	09-525-619	55.50
NO Mount 2" Door	B3	PULLPART.1042	55.50
NO Mount 2" Door	B4	PULLPART.1043	55.50
NO Mount 2" Door	B10	PULLPART.1044	55.50
NO Mount 2" Door	B10B	PULLPART.1045	55.50
NO Mount 2" Door	B26	PULLPART.1046	55.50
NO Mount 2" Door	B26D	PULLPART.1047	55.50
NO Mount 2" Door	S32	PULLPART.1048	55.50
NO Mount 2" Door	S32D	PULLPART.1049	55.50
NO Mount 2" Door	B15	PULLPART.1050	55.50
NO Mount 2 1/4" Door	B3	PULLPART.1051	55.50
NO Mount 2 1/4" Door	B4	PULLPART.1052	55.50

Contact Ives Customer Service for pricing on additional sizes and finishes

Bold pricing indicates item is in stock and available for **Fast Track** and **ProXpress**

IVES ARCHITECTURAL HARDWARE - Parts Price List

Description	Finish	Part No.	List Price Each
Old Mtg Style Push/Pull Combos (Non-HD) Mounting Packages for 9103EZ, 9190 (Continued)			
See Page 68 for which options can be used with each model.			
NO Mount 2 1/4" Door	B10	PULLPART.1053	\$55.50
NO Mount 2 1/4" Door	B10B	PULLPART.1054	55.50
NO Mount 2 1/4" Door	B26	PULLPART.1055	55.50
NO Mount 2 1/4" Door	B26D	PULLPART.1056	55.50
NO Mount 2 1/4" Door	S32	PULLPART.1057	55.50
NO Mount 2 1/4" Door	S32D	PULLPART.1058	55.50
NO Mount 2 1/4" Door	B15	PULLPART.1059	55.50
NS Mount 1.3/4" Door	B3,B4	09-524-605	32.00
NS Mount 1.3/4" Door	B15, B26, B26D, PA28, S32, S32D	09-524-630	32.00
NS Mount 1.3/4" Door	B10	09-524-612	32.00
NS Mount 1.3/4" Door	B10B	09-524-613	32.00
NS Mount 2" Door	B3,B4	PULLPART.1034	32.00
NS Mount 2" Door	B15, B26, B26D, PA28, S32, S32D	PULLPART.1035	32.00
NS Mount 2" Door	B10	PULLPART.1036	32.00
NS Mount 2" Door	B10B	PULLPART.1037	32.00
NS Mount 2" Door	B3,B4	PULLPART.1038	32.00
NS Mount 2" Door	B15, B26, B26D, PA28, S32, S32D	PULLPART.1039	32.00
NS Mount 2" Door	B10	PULLPART.1040	32.00
NS Mount 2" Door	B10B	PULLPART.1041	32.00
Push/Pull Combo HD Mounting Packages for 9103EZHD, 9145EZHD, 9190HD, 9190EZHD			
See Page 68 for which options can be used with each model.			
3/8HD NO Mount 1.1/2"-1.7/8" Door	US3	PULLPART.1115	55.50
3/8HD NO Mount 1.1/2"-1.7/8" Door	US4	PULLPART.1116	55.50
3/8HD NO Mount 1.1/2"-1.7/8" Door	US10	PULLPART.1117	55.50
3/8HD NO Mount 1.1/2"-1.7/8" Door	US10B	PULLPART.1118	55.50
3/8HD NO Mount 1.1/2"-1.7/8" Door	US15	PULLPART.1119	55.50
3/8HD NO Mount 1.1/2"-1.7/8" Door	US26	PULLPART.1120	55.50
3/8HD NO Mount 1.1/2"-1.7/8" Door	US26D	PULLPART.1121	55.50
3/8HD NO Mount 1.1/2"-1.7/8" Door	US32	PULLPART.1122	55.50
3/8HD NO Mount 1.1/2"-1.7/8" Door	US32D	PULLPART.1123	55.50
3/8HD NO Mount 2-2.1/4" Door	US3	PULLPART.1124	55.50
3/8HD NO Mount 2-2.1/4" Door	US4	PULLPART.1125	55.50
3/8HD NO Mount 2-2.1/4" Door	US10	PULLPART.1126	55.50
3/8HD NO Mount 2-2.1/4" Door	US10B	PULLPART.1127	55.50
3/8HD NO Mount 2-2.1/4" Door	US15	PULLPART.1128	55.50
3/8HD NO Mount 2-2.1/4" Door	US26	PULLPART.1129	55.50
3/8HD NO Mount 2-2.1/4" Door	US26D	PULLPART.1130	55.50
3/8HD NO Mount 2-2.1/4" Door	US32	PULLPART.1131	55.50
3/8HD NO Mount 2-2.1/4" Door	US32D	PULLPART.1132	55.50
3/8HD NS Mount 1.1/2"-1.7/8" Door	B15,B26,B26D	PULLPART.1107	32.00
3/8HD NS Mount 1.1/2"-1.7/8" Door	B3,B4	PULLPART.1108	32.00
3/8HD NS Mount 1.1/2"-1.7/8" Door	B10	PULLPART.1109	32.00
3/8HD NS Mount 1.1/2"-1.7/8" Door	B10B	PULLPART.1110	32.00
3/8HD NS Mount 2-2.1/4" Door	B15,B26,B26D	PULLPART.1111	32.00
3/8HD NS Mount 2-2.1/4" Door	B3,B4	PULLPART.1112	32.00
3/8HD NS Mount 2-2.1/4" Door	B10	PULLPART.1113	32.00
3/8HD NS Mount 2-2.1/4" Door	B10B	PULLPART.1114	32.00
3/8HD PQ Mount 3/8"-5/8" Door	US3	PULLPART.1219	102.10
3/8HD PQ Mount 3/8"-5/8" Door	US4	PULLPART.1220	102.10
3/8HD PQ Mount 3/8"-5/8" Door	US10	PULLPART.1221	102.10
3/8HD PQ Mount 3/8"-5/8" Door	US10B	PULLPART.1222	102.10
3/8HD PQ Mount 3/8"-5/8" Door	US15	PULLPART.1223	102.10

Contact Ives Customer Service for pricing on additional sizes and finishes

Bold pricing indicates item is in stock and available for **Fast Track** and **ProXpress**

IVES ARCHITECTURAL HARDWARE - Parts Price List

Description	Finish	Part No.	List Price Each
3/8HD PQ Mount 3/8"-5/8" Door	US26	PULLPART.1224	\$102.10
3/8HD PQ Mount 3/8"-5/8" Door	US26D	PULLPART.1225	102.10
Push/Pull Combo HD Mounting Packages for 9103EZHD, 9145EZHD, 9190HD, 9190EZHD (Continued)			
See Page 68 for which options can be used with each model.			
3/8HD PQ Mount 3/8"-5/8" Door	US32	PULLPART.1226	102.10
3/8HD PQ Mount 3/8"-5/8" Door	US32D	PULLPART.1227	102.10

Contact Ives Customer Service for pricing on additional sizes and finishes

Bold pricing indicates item is in stock and available for **Fast Track** and **ProXpress**

About Allegion

Allegion (NYSE: ALLE) creates peace of mind by pioneering safety and security. As a \$2 billion provider of security solutions for homes and businesses, Allegion employs more than 8,000 people and sells products in more than 120 countries across the world. Allegion comprises more than 25 global brands, including strategic brands CISA®, Interflex®, LCN®, Schlage® and Von Duprin®.

For more, visit www.allegion.com

KRYPTONITE ■ LCN ■  ■ STEELCRAFT ■ VON DUPRIN