



PRICE LIST 66BST
Effective: July 3, 2017



Mechanical and
Electronic Locks



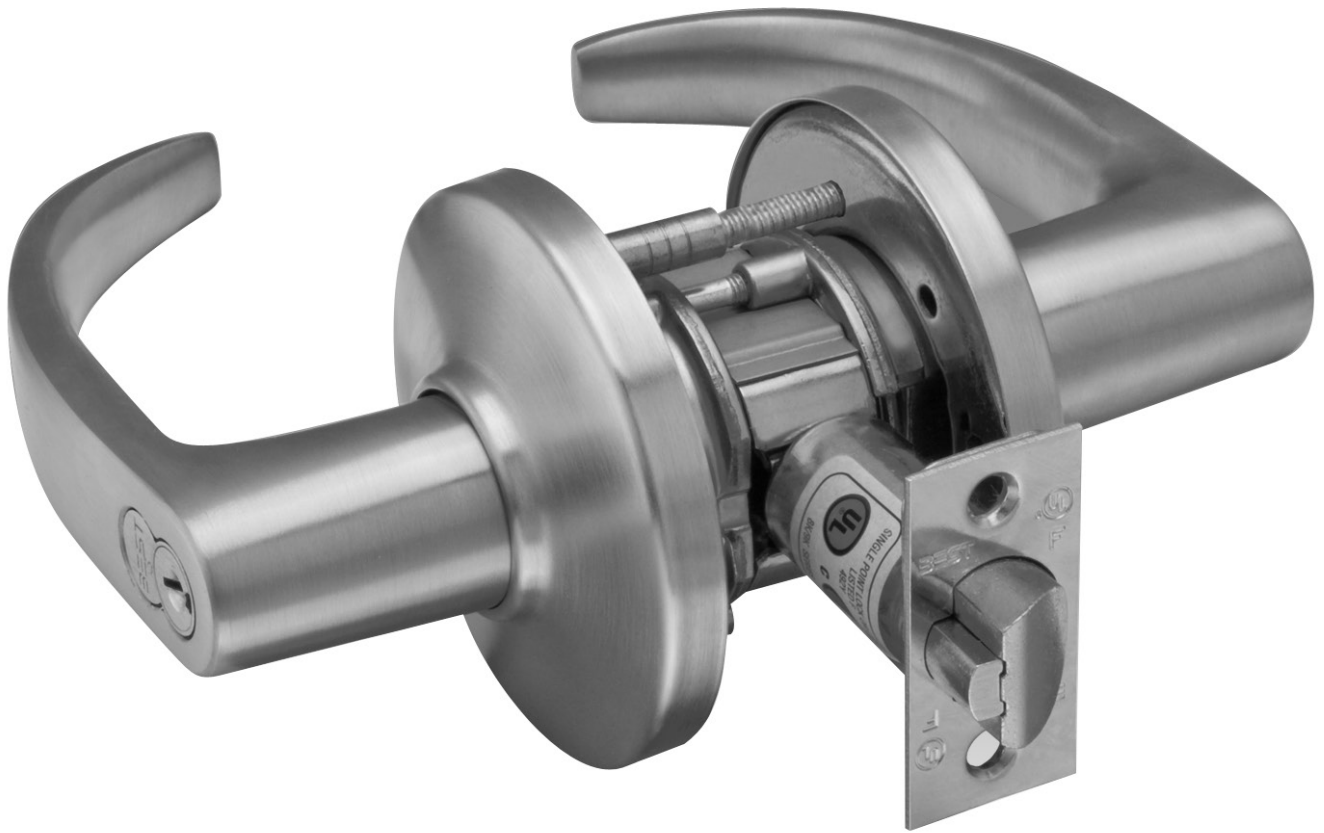

Note: Please contact us for price information on specialty items or options not shown in this price list.

STANLEY Security Solutions, Inc. reserves the right to make changes in designs and specifications or to make additions or improvements to its products without notice and without incurring any obligation to incorporate them on products previously manufactured.



Contents

Sales Policies	5	W Series Electric Switch Locks	57
Warranty	7	45HW Series Electromechanical Mortise Locks	58
STANLEY Patented Product Offering	9	47HW Series High Security Electromechanical Mortise Locks	59
STANLEY Masterkey Code and Masterkey Service Policy	11	8KW/9KW Series Electromechanical Cylindrical Locks	61
Architectural Finishes	13	Electromechanical Lock Accessories	62
BEST Standard & Premium Keys	14	Electric Strike 4	63
BEST Peaks Keys	15	Electric Strike 5	64
BEST Preferred Patented Keys	16	Electronic Lock Software & Accessories	66
BEST CORMAX Patented Keys	17	45HZ Keypad EZ Mortise Locks	67
B Series Padlocks	18	9KZ Keypad EZ Cylindrical Locks	68
BEST Standard & Premium Cores	20	EXZ Keypad EX Exit Trim	69
BEST Peaks Cores	21	45HG Offline G Series Mortise Locks	70
BEST Preferred Patented Cores	22	9KG Offline G Series Cylindrical Locks	71
BEST CORMAX Patented Cores	23	EXG Offline G Series Exit Trim	72
D Series Service Equipment	24	45HBV Offline V Series Mortise Locks	74
KRD Series Key Retaining Devices	26	9KBV Offline V Series Cylindrical Locks	75
QU-I C-SYSTEM Combining Tool Packages	27	EXBV Offline V Series Exit Trim	76
E Series Cylinders	28	45HM IDH MAX Mortise Locks	78
5E and 8E Series Utility Cylinders (Cam Locks)	30	9KM IDH MAX Cylindrical Locks	79
Keystone Web	31	STANLEY Wi-Q Technology Wireless Access Management Software & Accessories	80
45H Series Mortise Components	32	BEST 45HQ Wireless Mortise Locks with STANLEY Wi-Q Technology	82
47H Series High Security Mortise Lock	34	BEST 9KQ Wireless Cylindrical Locks with STANLEY Wi-Q Technology	83
48H and 49H Series Mortise Deadlocks	35	BEST EXQ Wireless Exit Trim with STANLEY Wi-Q Technology	84
40H Series Mortise Components	36	BEST Wireless Conversion Kits with STANLEY Wi-Q Technology	85
40H Strike Packages	37	STANLEY ID Express Station	86
40H Replacement Spindles	38	Electronic Lock Inside Escutcheon Conversion Kits	87
40H Faceplate Kits	38	45HOM Omnilock Wireless Mortise Locks	88
40H Visual Indicator	39	9KOM Omnilock Wireless Cylindrical Locks	89
J Series Semi-Trailer Kingpin Locks	40	OMEM Omnilock Electric Modules	90
6K Series Grade 2 Cylindrical Locks - Knobs	41	OMWMS Omnilock Wall Mount Systems	91
7K Series Grade 2 Cylindrical Locks - Levers	42	QASOM Quick Adapter for Pre-2004 Cylindrical Schlage D Lever Locks	92
8K Series Grade 1 Cylindrical Locks - Knobs	43	QAXOM Omnilock Wireless Quick Adapter for Exit Devices	93
9K Series Grade 1 Cylindrical Locks - Levers	45	Access Control System Parts and Accessories	94
AK Series Knob Adaptions	47	Non-BEST Chassis for OMEM	95
L Series Cabinet Locks	48	OMNILOCK Software	96
P Series Push Locks	49	STANLEY PAC	97
S Series Sliding Door Locks	50	Quoting & Ordering Policies	98
SPSL - STANLEY Patient Safety Lever	51	Return Policy and Fulfillment Issues	101
SSRL - STANLEY Seclusion Room / Time Out Room Locks	53	Forms	103
SEDA - STANLEY Emergency Door Alarm	54		
T Series Tubular Deadbolts	55		
9KX SHELTER Cylindrical Locks	56		



TERMS AND CONDITIONS OF SALE

The terms and conditions contained herein shall govern the sale of all Stanley products located in the Stanley price catalog and/or offered for sale by Stanley Security Solutions, Inc., except for those products as set forth under separate Stanley Value Added Reseller Agreements. The acceptance of any order is expressly made conditional upon your assent to these Terms and Conditions of Sale.

PRICES: Stanley reserves the right, in its sole discretion, to change or amend its price list (including, but not limited to, adding or removing Products from the price list), and standard terms and conditions of sale as contained in its catalogs, price list or published sales policies, without incurring any liability whatsoever to its Customer or others. All orders will be filled at the Stanley List Price in effect at the time of order placement. All prices are subject to change without notice and are not guaranteed.

TAXES: List prices do not include federal, state or local taxes.

ORDERS: No order for Products shall be deemed to have been accepted by Stanley until written notice of its acceptance is received by the Customer from Stanley via an order acknowledgement. Stanley reserves the right, in its sole discretion, to decline to accept any order. Purchase Orders will bind Stanley only to the extent accepted by Stanley's written confirmation or delivery.

Stanley will attempt to fill orders in the order in which they are received, subject to prior orders. However, Stanley reserves the right to allocate orders or fill an order or orders ahead of prior orders, if, in its judgment, the facts warrant such a change.

Any additional provisions in a Purchase Order, including any pre-printed terms, shall be void and not binding on Stanley, unless expressly accepted by Stanley. For greater certainty, the acceptance by Stanley of a Purchase Order shall not be deemed acceptance of the additional terms of such Purchase Order.

Stanley will accept orders via phone, email, fax or courier. Stanley will send out an order acknowledgement for all orders received via email, phone or fax.

Note: Receipt or possession of this price catalog does not grant approval to quote or purchase Stanley products. Please contact your Stanley Sales Representative for further details.

KEYING SYSTEM ORDERS: All orders of keying systems specifying delayed fulfillment must be fulfilled within twelve (12) months of the order date. Said request for fulfillment must include complete keying instructions for the order to be acknowledged with an estimated delivery date. Failure to properly request fulfillment of the order within twelve (12) months of the order date will make the order void and nonrefundable.

SPECIAL ORDERS: Any modification to a standard product configuration is considered a special order. No credits will be issued for returned special orders unless authorized by Stanley Customer Service.

INCOMPLETE ORDERS: An incomplete order is one that is not fully specified according to the appropriate nomenclature required for that product. Any incomplete order will not be entered and will be referred to the appropriate Stanley Sales Representative for resolution.

SAMPLES: Please contact your local Stanley Sales Representative for sample requests.

MINIMUM CHARGE: The expense of handling an order necessitates a minimum charge of \$50.00 net per invoice.

CREDIT LIMITS: Stanley's policy is to extend Net 30-day terms/open account combined with a credit line based on financial capacity. For all accounts Stanley requires a Credit Application and Sales Tax Exempt Certificate (if applicable). Stanley evaluates traditional sources of credit information: D&B, trade and bank references, financial information, and business plans. The supply of credit herein shall be at the discretion of Stanley. If available information and/or financial circumstances will not support open accounts terms, Stanley offers Cash in Advance and Credit Card (MasterCard or VISA) terms. Stanley performs periodic reviews of credit lines and terms of payment and may request updated financial information.

Stanley reserves the right to withhold delivery of Product if Customer does not meet Stanley's credit requirements for the amount of Product ordered, or the amount of Product which remains unpaid (whether or not overdue) exceeds the limit established by Stanley for Customer. Customer shall provide, at Stanley's request, an acceptable letter of credit or guarantee or security in a form and amount determined by Stanley.

If Customer shall become overdue on its account or otherwise defaults in any payment to Stanley or if its financial condition shall at any time appear inadequate to warranty further shipment on an open account basis, Stanley shall have the right, without liability, to refuse to accept any or all orders, to cancel any and all orders, to delay shipments, or to require advance payment before accepting or shipping any orders. All orders and all shipments are subject to approval by the Stanley Credit Department.

PAYMENT TERMS: Stanley standard payment terms are 2% 15, net 30 days from date of invoice.

Effective September 28, 2014, a \$45.00 convenience fee will apply to all payments made by Credit Card towards open invoices on your account. You may choose to pay by credit card by reaching out to your Credit Analyst directly in order to process payment. You can avoid paying the \$45.00 convenience fee by enrolling and paying open invoices via Billtrust Invoice Gateway (<https://secure.billtrust.com/stanleymechnical/ig/signin>) with an ACH Payment (bank transfer from checking or savings account) free of charge. Payments by check, or money order should continue to be sent directly to the remit-to address noted on invoices.

Stanley shall be entitled to charge and Customer shall pay interest on overdue invoices at the rate of two percent (2%) per month calculated from the date of the invoice to the date of payment, including any attorney fees incurred by Stanley resulting from the collection of such overdue payment. Customer shall pay all sums owing to Stanley without any deduction or abatement and Customer shall have no right of set-off.

In the event that Customer disputes any portion of the payment due, Customer shall be obligated to pay the balance which is not the subject of dispute.

Without limiting any other rights it may have under these terms of sale and applicable law, all of Stanley's obligations under this Agreement, including obligations of supply, or any Purchase Order, can be suspended or cancelled should Customer be delinquent in making payment for previously shipped Products.

October 2015



TERMS AND CONDITIONS OF SALE (continued)

INTERNATIONAL SALES:

International Resellers located outside of the United States of America who place orders are subject to and must pay by (1) Cash in Advance, (2) Confirmed Irrevocable Letter of Credit, (3) Standby Letter of Credit.

All international shipments shall be FCA (Incoterms 2010) from Stanley's facility in Indianapolis, Indiana USA. Stanley shall be deemed to have delivered all Products and related goods when such are put in the custody of a carrier at Stanley's plant or warehouse above, at which time all title and risk of loss or damage shall pass to Customer.

SHIPPING/FREIGHT: All Products shall be shipped FOB Origin domestic or FCA International (INCOTERMS 2010) from Stanley's facility in Indianapolis, Indiana USA. Stanley shall be deemed to have delivered all Products and related goods when such are put in the custody of a carrier at Stanley's plant or warehouse above, at which time all title, risk of loss or damage shall pass to Customer. All shipments will be made in accordance with the preferred routing, carrier assignments, and operational guidelines of Stanley. Customer shall bear all costs of freight, insurance and associated costs and shall make all arrangements for same.

Single or combined shipments including Stanley lock sets, exit devices, hinges and door closers will be considered for free freight with orders at or above \$5000 net (product combination must be on same purchase order). Orders less than \$5,000 will be shipped freight prepaid with shipping cost added to the invoice, including a nominal freight charge to be determined by Stanley at time of shipping.

Hinge only orders will be considered for free freight with orders at or above \$750 net. Orders less than \$750 will be shipped freight prepaid with shipping cost added to the invoice, including a nominal freight charge to be determined by Stanley at time of shipping.

These freight terms apply only to a single destination within the contiguous United States.

Should a shipment qualify for one of Stanley's free freight programs, the Products shall be shipped FOB Origin domestic (with exception to prepaid freight) or FCA International (INCOTERMS 2010) (with exception to prepaid freight) from Stanley's facility in Indianapolis, Indiana USA.

DELIVERY: Orders shall be acknowledged and given a scheduled delivery date based on estimated manufacturing lead times. Manufacturing lead time will begin once all information is received to process an order. Delivery dates given by Stanley as part of order acknowledgment for accepted orders for Products or related goods will be honored by Stanley on a best effort basis. Shipping dates shown on order acknowledgments are based upon Stanley's estimate and cannot be guaranteed. Stanley will not be liable for any loss or damage resulting from delay in filling orders, including any direct or consequential loss or damage. Stanley reserves the right to make partial shipments unless the order specifies otherwise.

CHANGES/CANCELLATIONS: After orders are entered for manufacturing, changes or cancellations cannot be accepted without Stanley written permission, and may be subject to a change or cancellation charge equivalent to 30% of the purchase price.

Orders for special and/or custom designed goods not immediately saleable to another customer are not changeable, cancelable, or returnable.

RETURNED GOODS: Stanley Customer Service MUST authorize all warranty and non-warranty related returns. Requests for returns can be initiated by submitting an email to RGACreditGRP@sbdinc.com. Only goods with an invoice date of less than one (1) year will be considered for a non-warranty related return and product must be returned in original packaging and in a resalable condition. All material returned to Stanley, regardless of the reason, must have a correct RA number applied to the outside of the shipping carton. A restocking charge of 30% of the purchase price will be applied to the Customer's account except for warranty returns. Transportation charges of returned goods must be prepaid by Customer. All goods must be returned within sixty (60) calendar days of RA issue date. Product not returned in salable condition or after sixty (60) days of the RA issue date is subject to disposal by Stanley with no credit issued.

Stanley cannot authorize the return of discontinued product. Under no circumstances will special order items be accepted for return, unless covered by warranty.

EXPORT REGULATIONS: Customer agrees to conform to, and abide by, the export laws and regulations of the US, including, but not limited to, the Export Administration Act of 1979 as amended and its implementing regulations. Diversion contrary to US laws and regulations is prohibited.

MASTERKEYING: Stanley Masterkey Code and Masterkey Service Policy can be found at www.bestaccess.com.

LIMITED WARRANTY: The terms and conditions outlined above are subject to Stanley's Limited Warranty, which is included in the Stanley Price Catalog and is incorporated herein by reference. Upon return of a defective product, Stanley shall either repair or replace the product, in its sole discretion, in accordance with our standard warranty.

EXCEPT AS SET FORTH HEREIN, STANLEY MAKES NO WARRANTIES, EXPRESSED OR IMPLIED, AND BUYER ACKNOWLEDGES THAT NO REPRESENTATIONS, WARRANTIES, PROMISES OR STATEMENTS HAVE BEEN MADE BY STANLEY, WITH RESPECT TO THIS PRODUCT, OR ANY PART OR PORTION THEREOF. IN ADDITION, STANLEY MAKES NO WARRANTY OF MERCHANTABILITY OF THIS PRODUCT OR ANY PART OR PORTION THEREOF, FOR ANY PURPOSE, NOR ANY WARRANTY WHICH EXTENDS BEYOND THE DESCRIPTION ON THE FACE HEREOF. STANLEY SHALL NOT, IN ANY EVENT, BE LIABLE FOR ANY CONSEQUENTIAL OR INCIDENTAL DAMAGES SUFFERED BY BUYER OR ANYONE CLAIMING BY, THROUGH OR UNDER BUYER, AS A RESULT OF THE CONDITION OF THIS PRODUCT, OR ANY PART OR PORTION THEREOF, AND THERE ARE NO ORAL OR WRITTEN UNDERTAKINGS OR AGREEMENTS OF ANY TYPE PROVIDED BY STANLEY EXCEPT AS EXPRESSLY SET FORTH HEREIN. SOME STATES DO NOT ALLOW LIMITATIONS ON HOW LONG AN IMPLIED WARRANTY LASTS OR PROHIBIT THE EXCLUSION OR LIMITATION OF INCIDENTAL OR CONSEQUENTIAL DAMAGES, SO THE ABOVE LIMITATION AND EXCLUSIONS MAY NOT APPLY IN YOUR STATE.

GOVERNING LAW: These Terms and Conditions of Sale and any subsequent sales agreements between Stanley and Customer shall be construed in accordance with the laws of the State of Indiana. The United Nations Convention on Contracts for the International Sale of Goods shall not apply to this Agreement.

October 2015



WARRANTY

What is Covered: Stanley Security Solutions, Inc. ("Stanley") warrants that the Products manufactured by Stanley, identified below, and sold under its trade names "STANLEY" and "BEST" are free of defects in materials and workmanship as outlined below. The sole and exclusive liability of Stanley under this warranty is limited to the repair or replacement of any Product or component part covered by the warranty at the sole discretion of Stanley.

Who is Covered: This warranty is extended only to the Seller's distributors of Products and the end user who purchases Products for purposes other than resale (collectively, "Purchaser").

Hardware Warranty Period:

The following products warranty term shall be limited lifetime for a period of the useful life of the building in which the product is originally installed:

- **45H/47H Mechanical Mortise Lock**
- **48H/49H Mortise Deadlock**

The following products shall be warranted for ten (10) years from the date of sale:

- **9K Mechanical Cylindrical Lock**

The following products shall be warranted for five (5) years from the date of sale:

- **45HW and 47HW Electromechanical Mortise Lock**

The following products shall be warranted for three (3) years from the date of sale:

- **8K Mechanical Cylindrical Lock**
- **8K/9K Electro-mechanical Cylindrical Lock**
- **9KZ Keypad EZ Cylindrical Lock**
- **9KM IDH Max Cylindrical Lock**
- **5K, 6K, and 7KC Cylindrical Locks**
- **8T/7T Tubular Locks**
- **1E, 5E, 8E Cylinders Locks**
- **45HZ Keypad EZ Mortise Lock**
- **EXZ Keypad**
- **45HM IDH Max Mortise Lock**
- **1C, 2C, 3C, 5C, 6C Cores**
- **1A Keys**
- **1AM, 1AX Keys (CORMAX)**
- **AD433 Key Combinator & Equipment**
- **11B, 21B, 41B family Padlocks**
- **1W Switch Locks**
- **S Sliding Door Locks**
- **45HG, 9KG, 45HBV, 9KBV BASIS Locks**
- **45HN, 9KN Electrified Locks**
- **45HQ, 9KQ and EXQ locks using Stanley Wi-Q(tm) Technology**
- **AK Series Knob Adaptations**
- **5L, 3L, 2P Cabinet Locks**
- **SPSL, SSRL, SEDA Stanley Patient Safety Lever, Seclusion Room Locks, Emergency Door Alarms**

The following products shall be warranted for one (1) year from the date of sale:

- **45HOM, 9KOM, OMEM, OMWMS, QASOM, QAXOM, Stanley Portal Gateways, Wireless Access Controllers, Antennas** and other products using Stanley Wi-Q(tm) Technology not specifically mentioned
- **1CB, 1CK, 1AF Kaba Cores & Keys**
- **Stanley Portal Gateways, Wireless Access Controllers, Antennas** and other products using Stanley Wi-Q™ Technology not specifically mentioned

Finishes shall be warranted for three (3) years from the date of sale excluding US10B/613 "Oil Rubbed Bronze" finish.

Stanley Wi-Q™ Technology and B.A.S.I.S. Software:

- Stanley warrants that all software shall be free from defects in materials and workmanship and will function in substantial accordance to the specifications for a period of one (1) year from the date of installation.
- Specific Limitations:
 - This warranty does not cover any post-sales technical support under the following circumstances:
 - Problems caused by misuse of software or hardware
 - Failure to provide a network connection or site phone line for a modem connection, if deemed necessary by Stanley
 - Technical support for network software products
 - Technical support for software installed on computer hardware or computer operating system that is no longer commercially available for purchase.

Warranty Claims: Any Products believed to be defective as covered by this warranty may not be returned without prior written Returned Materials Authorization (RMA) from Stanley Product Support (800) 392-5209 covering specific items and quantities within thirty (30) days from the discovery of the alleged defect(s). Stanley will inform the purchaser where to ship said Product(s), shipping charges prepaid by you, for examination. In the event such examination reveals a defect covered by this warranty; Stanley will, at its sole option, repair or replace the Product, and return it or its replacement to the purchaser, with charges only for shipping.

Exclusions: This warranty specifically excludes, and Stanley shall not be held responsible for the following:

- COSTS ASSOCIATED WITH INSTALLING, REMOVING OR REINSTALLATION OF THE PRODUCT.**
- Damage caused by Product malfunction or failure attributable to acts of God.
- Improper use or installation.
- Poor or no maintenance.

Rev. Date October 2015



WARRANTY

- e) Work performed by someone other than an Authorized Stanley technician.
- f) Failure to follow Stanley's operating instructions or environmental specifications.
- g) Incorrect application, modification, vandalism, erosion or corrosion, shipping and/or handling, improper storage, accident, misuse, abuse or any other cause not within the control of Stanley.
- h) This warranty is void if any modification is made to the warranty product, regardless of whether the modification causes or contributes to the alleged defect. All modifications are made at the risk and expense of the party making the modifications.
- i) Stanley shall not be liable for any repairs, replacements, or adjustments to the product or any costs of labor performed by the Purchaser or others without Stanley's prior written approval.
- j) Stanley provides no warranty or guarantee that its cores and/or cylinders will function properly or be mechanically compatible with products not manufactured by Stanley.
- k) The US10B/613 finish is considered to be a living finish that will change over time with use and age and is expressly excluded from this warranty. The finish changes that occur are indicative of normal wear and tear and reflect the essence of a living finish. The finish changes are not considered manufacturing defects and are not covered by this warranty.

Third Party Warranty: Except as otherwise provided above, Stanley makes no warranty, express or implied, with regard to third party hardware or software and expressly disclaims the implied warranties or conditions of merchantability or merchantable quality, fitness for a particular purpose, title, infringement and those arising by statute or otherwise in law. Customer's sole recourse for warranty claims is with the manufacturer of the Product. However, Stanley agrees to pass through any third party warranty that Stanley receives from the manufacturer of the Products to Purchaser. The extent of any third party warranty details, terms and conditions, remedies and procedures may be expressly stated on, or packaged with, or otherwise accompanying the Products.

LIMITATION OF WARRANTIES: THIS WARRANTY IS GIVEN EXPRESSLY AND IN PLACE OF ALL OTHER WARRANTIES, EXPRESS OR IMPLIED, INCLUDING ANY IMPLIED WARRANTIES OF MERCHANTABILITY OR FITNESS FOR PARTICULAR PURPOSE. THERE ARE NO UNDERSTANDINGS, AGREEMENTS, REPRESENTATIONS, OR WARRANTIES NOT SPECIFIED HEREIN.

STANLEY SHALL NOT, IN ANY EVENT, BE LIABLE FOR ANY CONSEQUENTIAL, INCIDENTAL, INDIRECT, SPECIAL OR PUNITIVE DAMAGES SUFFERED BY PURCHASER OR ANYONE CLAIMING BY, THROUGH OR UNDER PURCHASER, AS A RESULT OF THE CONDITION OF THIS PRODUCT, OR ANY PART OR PORTION THEREOF.

SOME STATES DO NOT ALLOW LIMITATIONS ON HOW LONG AN IMPLIED WARRANTY LASTS OR PROHIBIT THE EXCLUSION OR LIMITATION OF INCIDENTAL OR CONSEQUENTIAL DAMAGES, SO THE ABOVE LIMITATION AND EXCLUSIONS MAY NOT APPLY IN YOUR STATE.

THIS WARRANTY IS GOVERNED BY THE LAW OF THE STATE OF INDIANA WITHOUT REGARD TO ITS CONFLICTS OF LAW PRINCIPLES. STANLEY AND PURCHASER AGREE THAT THE UNITED NATIONS CONVENTION ON CONTRACTS FOR THE INTERNATIONAL SALE OF GOODS SHALL NOT APPLY TO SALE OF THE PRODUCTS COVERED BY THIS WARRANTY.

FOR WARRANTY ON THE SHELTER 9KX SERIES PRODUCTS AND ACCESSORIES, PLEASE SEE SEPARATE SHELTER 9KX SERIES PRODUCT AND ACCESSORIES WARRANTY AT WWW.BESTSHELTERLOCKDOWN.COM.



STANLEY PATENTED PRODUCT ORDERING & LICENSE

SALE OF STANLEY PATENTED PRODUCT: In accordance with the Stanley Masterkey Code and Masterkey Service Policy, only Authorized Distributors meeting certain necessary qualifications and standards shall be selected by Stanley to sell Stanley Patented Product. Selection shall be at the sole discretion of Stanley and shall be evidenced in writing via the Distributor Agreement or its select addendums.

STOCKING OF STANLEY PATENTED PRODUCT: Furthermore, Stanley may authorize only select Authorized Distributors to purchase and stock Stanley Patented Product and have access to Stanley Patented Masterkey Codes by entering into a [Stanley Patented Masterkey System Distributor Agreement Addendum](#) (the "Authorized Stocking Distributor") As a condition to the Authorized Stocking Distributor's continued access to Stanley Patented Masterkey Codes, it must comply at all times with the [Stanley Patented Key Systems Security Procedure](#).

SECURITY AUTHORIZATION FORM: It is a responsibility of the Authorized Distributor to ensure that Stanley Patented Product does not end up in the possession of unauthorized individuals or entities. The Authorized Distributor must ensure that the End User completes a Stanley Patented Masterkey System Security Authorization Form (the "Security Authorization Form"). The Security Authorization Form designates those individuals within the End User's organization that are authorized to place orders with the Authorized Distributor for Stanley Patented Product. The [Security Authorization Form](#) must be completed and signed by the End User.

It is the Authorized Distributor's full responsibility to validate the End User's signature as identified on the [Security Authorization Form](#) prior to accepting any orders for Stanley Patented Product.

In certain circumstances the Authorized Distributor selling and/or stocking the Stanley Patented Product will not contract directly with the End User. In these circumstances, the Authorized Distributor is required to work with its reseller to ultimately ensure that the End User submits a signed [Security Authorization Form](#) to Stanley.

For those Distributors who have been authorized by Stanley to stock Stanley Patented Product, it is their responsibility to ensure that they have a completed [Security Authorization Form](#) on file for each End User that places an order with the Authorized Stocking Distributor for Stanley Patented product and that the Authorized Stocking Distributor authenticates the signature of each Stanley Patented Product order utilizing the [Security Authorization Form](#).

Stanley shall have the right to audit all [Security Authorization Forms](#) maintained by the Authorized Distributors for completeness, accuracy and compliance with this Policy.

BEST CORMAX™ PATENTED KEYING SYSTEM-PATENT LICENSE:

1. The Best Cormax keying system being offered for sale under this price catalog is protected by valid and enforceable patents issued by the United States Patent and Trademark Office pursuant to United States Federal Law (including U.S. Patent Nos. 7,681,425 and 5,615,566 (also designated as US RE 39,364) (collectively, the "Stanley Patents"). The rights to the Stanley Patents belong to Stanley Security Solutions, Inc. ("Stanley"). The Best Cormax keying system is comprised of two main components, a core and one or more keys. The combination of the Best Cormax core and key(s) is protected by the Stanley Patents. The Best Cormax keys, key blanks, and cores contain registered trademarks belonging to Stanley. **Stanley considers its patent and trademark rights to be valuable intellectual property assets that are important in protecting security and maintaining key control of its products. Accordingly, it is in Stanley's best interest and, more importantly, it is in the best interest of its end users, that the Best Cormax system be managed in a manner that guards against unauthorized key duplication, which compromises the security of the Best Cormax system. As a condition of purchase of a Best Cormax system from Stanley or one of its authorized distributors, the following limitations on the express and implied contractual and intellectual property rights with respect to the Best Cormax system and the Stanley Patents shall apply:**

a. All Best Cormax systems shall be sold with a limited license to practice the Stanley Patents by combining and using (i) the Best Cormax core that is purchased with the Best Cormax system with (ii) the Best Cormax key(s) and/or key blanks(s) that are purchased with the Best Cormax system.

b. This license is conditioned upon the purchase of a Best Cormax core and key (or core and key blank) combination only from Stanley or one of its authorized distributors. Only Stanley and its authorized distributors are authorized to sell the core and key(s)/blank(s) that comprise the Best Cormax system. All other sales of those items, individually or together, including either finished Best Cormax keys or unfinished key blanks suitable for finishing into Best Cormax keys, by any party other than Stanley or one of its authorized distributors, for purposes of making the patented core and key combination, are not authorized sales and are excluded from this license.

c. In the event that an end user sells a Best Cormax core, either standing alone or in connection with a sale of the structure or building in which it is installed, to a third party, the end user shall be required to notify the third-party purchaser of the terms and conditions and limitations of this license, which equally apply to the third party purchaser.

October 2015



STANLEY PATENTED PRODUCT ORDERING & LICENSE (continued)

d. Stanley does not grant under the license, the right to sell any Best Cormax keys or key blanks to a third party, except in connection with a sale of the corresponding Best Cormax core in a manner that complies with the terms, conditions, and limitations of this license.

e. Best Cormax keys and/or key blanks will be shipped by Stanley or one of its authorized distributors directly and only to employees, as designated in the Security Authorization Form.

f. In order to maintain the integrity of the Best Cormax system, the Best Cormax key or key blank should not be altered at any time to operate any core/cylinder for which such key or key blank was not originally intended.

g. In the event that any of the procedures outlined herein are not strictly followed with respect to the handling of Best Cormax keys and key blanks, Stanley may require following good faith discussions, the prompt return via UPS/AOD or equivalent, of all Best Cormax keys and/or blanks. Those items, in like new condition, shall be repurchased by Stanley at the original sale price less a restocking fee.

h. Should any terms of this license be found to be invalid, by operation of law or otherwise, all other provisions herein shall remain in full force and effect.

October 2015



STANLEY MASTERKEY CODE AND MASTERKEY SERVICE POLICY

I. DISTRIBUTOR MASTERKEY SERVICES

All Stanley Authorized Distributors, Aftermarket Wholesalers, and Locksmiths ("Authorized Distributors") can create, modify or extend masterkey codes for the benefit of their end user customers ("End Users") for Stanley non-patented masterkey systems; provided, however, the services must be performed in line with industry standards. With the express written permission of Stanley, select Authorized Distributors can create, modify or extend masterkey codes for the benefit of End Users for a Stanley Patented Masterkey System (pursuant to the terms and conditions of Section C below). Authorized Distributor's failure to comply with the terms of this policy could result in Stanley's termination of its Distributor Agreement as well as Stanley's pursuit of any remedies available at law.

A. END USER INFORMATION AND CODE RELEASE:

All masterkey codes (both patented and non-patented) previously generated by Stanley are available for distribution to End Users (and/or their designated Authorized Distributor, if applicable) via the End User Web Portal at <http://customerservice.stanleysecuritysolutions.com/mcp/>. For a hard copy of the End User Information and Code Release Form, please contact your Stanley End User Consultant. End user codes will be distributed solely to those Authorized Distributors (a) identified by the End User on a fully executed End User Information and Code Release Form received by Stanley, and (b) for the release of Stanley Patented Masterkey Codes, the Authorized Distributor is authorized by Stanley to receive and process Stanley Patented Masterkey Codes (as more fully described in Section C below.) No exceptions will be made to this policy.

B. STANLEY NON-PATENTED MASTERKEY SYSTEM

Effective September 4, 2012 Stanley will no longer require a Security Authorization Form to be signed by the End User prior to Stanley and/or its Authorized Distributor accepting core and key orders for non-patented keying systems. All valid End User communications for orders related to non-patented keying systems will be fulfilled at the End User's liability.

C. STANLEY PATENTED MASTERKEY SYSTEM

The Stanley Patented Masterkey System provides a higher level of protection against unauthorized key duplication and crossovers and, in order to maintain the quality of a Stanley Patented Masterkey System, the following terms and conditions of this policy shall apply to any and all Authorized Distributors with access to Stanley Patented Masterkey Systems. For the purpose of this policy, "Stanley Patented Product" shall mean the Stanley Best Cormax (including cores and keys), as well as any and all future product Stanley designates as patented product for the purpose of this policy. "Stanley Patented Masterkey Systems" and "Stanley Patented Masterkey Codes" shall mean the respective masterkey system or codes of any Stanley Patented Masterkey Product.

Sale of Stanley Patented Product: As further described in this C, only those Authorized Distributors meeting certain necessary qualifications and standards shall be selected by Stanley to sell Stanley Patented Product. Selection shall be at the sole discretion of Stanley and shall be evidenced in writing via the Distributor Agreement or its select addendums.

Stanley Patented Security Authorization Form: It is a responsibility of the Authorized Distributor to ensure that Stanley Patented Product does not end up in the possession of unauthorized individuals or entities. The Authorized Distributor must ensure that the End User completes a Stanley Patented Masterkey System Security Authorization Form (the "Security Authorization Form") as outlined in this Section. The Security Authorization Form designates those individuals within the End User's organization that are authorized to place orders with the Authorized Distributor for Stanley Patented Product. The Security Authorization Form must be completed and signed by the End User.

It is the Authorized Distributor's full responsibility to validate the End User's signature as identified on the Security Authorization Form prior to accepting any orders for Stanley Patented Product. In certain circumstances the Authorized Distributor selling the Stanley Patented Product will not contract directly with the End User. In these circumstances, the Authorized Distributor is required to work with its reseller to ultimately ensure that the End User submits a signed Security Authorization Form to Stanley. Stanley shall have the right to audit all Security Authorization Forms maintained by the Authorized Distributors for completeness, accuracy and compliance with this Policy.

Sale of Combined Stanley Patented Product through Distributor: Stanley may authorize select Authorized Distributor to purchase and resell to an End User Stanley Patented Product that has been combined by Stanley Personnel. In this instance, a Security Authorization Form must be completed and signed by the End User and provided by the Authorized Distributor to Stanley with each Stanley Patented Product order.

Stocking of Stanley Patented Product: Stanley may authorize select Authorized Distributors to purchase and stock Stanley Patented Product and have access to Stanley Patented Masterkey Codes by entering into a Stanley Patented Masterkey System Distributor Agreement Addendum (the "Authorized Stocking Distributor") As a condition to the Authorized Stocking Distributor's continued access to Stanley Patented Masterkey Codes, it must comply at all times with the Stanley Patented Key Systems Security Procedure. In addition, it is the responsibility of the Authorized Stocking Distributor to ensure that they have a completed Security Authorization Form on file for each End User that places an order with the Authorized Stocking Distributor for Stanley Patented product and that the Authorized Stocking Distributor authenticates the signature of each Stanley Patented Product order utilizing the Security Authorization Form.

October 2015



STANLEY MASTERKEY CODE AND MASTERKEY SERVICE POLICY (continued)

Stanley Patented Masterkey Code Generation: To assist in reducing the possibility of duplication within a keying system and ensure security, all Stanley Patented Masterkey Codes must be created, modified and/or extended by Stanley's masterkey personnel and/or an Authorized Stocking Distributor. The unauthorized duplication or release of Stanley Patented Masterkey Codes to non-authorized people or organizations, including, but not limited to, unauthorized distributors, wholesalers, private locksmiths, other lock manufacturers, architects, or contractors, is a violation of this policy as well as the infringement of patent rights and other intellectual property rights of Stanley. In addition to any other recourse available under law, the unauthorized release of Stanley Patented Masterkey Codes by any Authorized Stocking Distributor shall result in immediate termination.

Stanley Patented Masterkey System Exclusive Keyways: Upon request from an End User to release Stanley Patented Masterkey Codes previously generated by Stanley that are on an exclusive keyway, Stanley will send a notification to the End User reminding them that their patented codes are on an exclusive keyway. Stanley will provide a copy of this notice to the Authorized Stocking Distributor.

To assist in reducing the possibility of duplication within an End User exclusive keying system and ensure security, all exclusive Stanley Patented Masterkey Codes must be created, modified and/or extended and recorded in Stanley's BESTCode masterkey code management tool.

Should Stanley approve an Authorized Stocking Distributor to establish a Stanley Patented Masterkey System on an exclusive keyway, the Authorized Stocking Distributor shall be required to sign a Stanley Patented Masterkey System Exclusive Keyway Addendum. To assist in reducing the possibility of duplication within a Distributor exclusive keying system and ensure security, all exclusive Stanley Patented Masterkey Codes must be created, modified and/or extended and recorded in Stanley's BESTCode masterkey code management tool.

Copies of Stanley Patented Masterkey Codes: Stanley shall have a right to a copy of all Stanley Patented Masterkey Codes that have been originated, modified, extended or otherwise maintained by the Authorized Stocking Distributor in the Stanley BESTCode system in order for Stanley to be able to provide continued support either directly, or indirectly, to the End User.

II. STANLEY MASTERKEY SERVICES

A. STANLEY MASTERKEY SERVICES PROVIDED TO DISTRIBUTOR:

Stanley, upon request and at its sole discretion, may provide select masterkey services to an Authorized Distributor for both non-patented masterkey systems and Stanley Patented Masterkey Systems. In order for an Authorized Distributor to place an order for the extension of, or modification to, a masterkey system

previously created or maintained by Stanley, the End User must have selected that Authorized Distributor as its authorized designee in the End User Information & Code Release Form received by Stanley. Complete keying instructions must be given before a Stanley order can be properly acknowledged with an estimated delivery date. Stanley reserves the right to charge for the service of a customized masterkey security solution with the purchase of a Stanley product. A masterkey service charge will be assessed for each order for cylinders or cores for use in non-Stanley manufactured locks for which Stanley has an equivalent product. Stanley Patented Masterkey System products shall not be provided without the associated masterkey services being provided by Stanley. All Masterkey Services provided by Stanley shall be subject to the terms and conditions of the Stanley Masterkey Service Order Acknowledgment which shall be provided upon acceptance of the order for Masterkey Services.

B. STANLEY BESTCODE:

Stanley may, in its sole discretion, make available its BESTCode masterkey code management tool to select Authorized Distributors that meet certain training and certification requirements. If offered, BESTCode will be made available for an annual subscription fee as outlined in the Stanley pricing catalog. All codes made available to Authorized Distributors in the BESTCode system shall be subject to the BESTCode User License Agreement and will be provided in accordance with this Policy. The BESTCode masterkey code management tool is not available for use with Stanley Commercial Hardware products.

III. FORMS

For a copy of the following forms please contact the Stanley End User Consultant.

- End User Information and Code Release Agreement
- Stanley Patented Masterkey System Distributor Agreement Addendum (Exhibit B)
- Stanley Patented Masterkey System Security Authorization Form
- Stanley Patented Key Systems Security Procedure
- Stanley Patented Masterkey System Exclusive Keyway Addendum
- Stanley Patented Masterkey System End User Specific Distributor Agreement Addendum (Exhibit D)

Stanley reserves the right to change, modify or update this Policy at any time, in its sole discretion.

October 2015



Architectural Finishes

BHMA No.	U.S. No.	Description
605	3	Bright brass, clear coated
606	4	Satin brass, clear coated
611	9	Bright bronze, clear coated
612	10	Satin bronze, clear coated
613	10B	Oxidized satin bronze, oil rubbed
618	14	Bright nickel plated, clear coated
619	15	Satin nickel plated, clear coated
622	19	Flat black, coated
625	26	Bright chromium plated
626	26D	Satin chromium plated
627	27	Satin aluminum, clear coated
628	28	Satin aluminum, clear anodized
629	32	Bright stainless steel
630	32D	Satin stainless steel
690	20	Dark bronze coated



BEST Standard & Premium Keys

How To Order

1A	1	A	1		
Key Shape (Bow)	Key Type	Keyway	Cut Code	Key Stamp	Options
1A – Standard 1AP – Premium 2A – Large round 3A – Large rectangular 4A – Access bow 9A – Blockout blade	0 – Blockout blade 1 – Operating or blank 2 – Control 3 – Master 4 – Submaster 5 – Grandmaster 9 – Extractor key	Designate specific keyway (A, E, etc.) or multiple keyways if ordering a multi-milled key.	1 – Blank 2 – Cut 4 – Special A4	KS654 x KS292 – BEST logo full embossing with stars (1A & 1AP only) KS112 – “U.S. Gov’t do not duplicate” KS567 – Premium Specify KS#. Price for most custom design stamps available upon request.	B* – Long blade (1A only) H* – No hole (2A only) N* – Long nose (1A only) NKW – No keyway designation (standard on 1AP) P* – Plastic insert (4A only) S* – Key serialization

*Indicates extra cost option; see below.

If keys are cut, you must specify keymark and number of each marking.

DESCRIPTION	PREMIUM	STANDARD
1A SERIES		
Blanks	4.80	2.70
Operating-cut	12.60	8.90
Control, Master, SM or GM-cut	16.70	9.80
2A, 3A & 4A SERIES		
Blanks	N/A	4.70
Operating-cut	N/A	9.80
Control, Master SM or GM-cut	N/A	14.60
9A SERIES		
Blockout blades	14.60	10.30
Extractor key (9A9)	14.60	10.30

EXTRA COST OPTIONS*	OPTION CODE	ADD-ON
Double milling	Specific Keyways	3.20
Triple milling		5.10
Quadruple milling		7.50
Five milled		12.00
Long blade (1A only)	B	3.20
No hole (2A only)	H	2.10
Long nose (1A only)	N	6.20
Plastic insert (4A only)	P	3.20
Key serialization / key	S	2.10

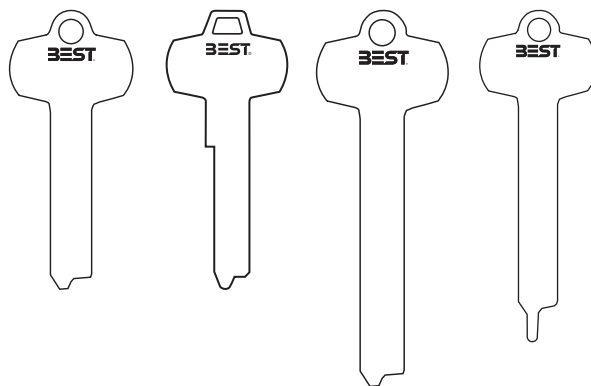

1A Standard 1AP Premium 1A Long Blade (B)* 1A Long Nose (N)*

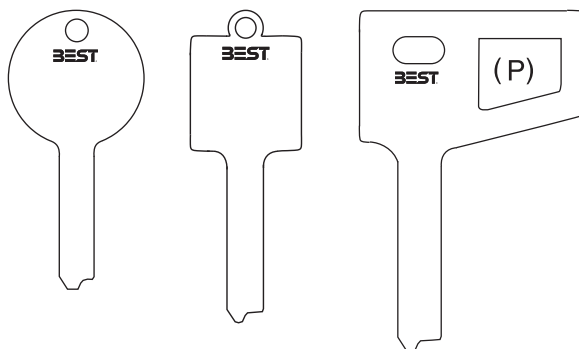

2A 3A 4A*



9A0 Blockout Blade 9A9 Extractor Key



BEST Peaks® Keys

How To Order

1AK	1	B1	1	7	150	
Key Shape (Bow)	Key Type	Keyway	Cut Code	Pin Size	Key Series	Options
1AK – BEST Peaks 9AK – Blockout blade	0 – Blockout blade 1 – Operating 2 – Control 3 – Master 4 – Submaster 5 – Grandmaster 9 – Extractor key	B1 B2 B3 B4 B5 B6 B7 B8 B9 B10	1 – Blank 2 – Cut	6 – 6-pin (140 & 150 series) 7 – 7-pin (150 series only) 140 Series = 1CK cores 150 Series = 1CB cores	150 140	CS* – Custom stamp for key bow (Note 1)

*Indicates extra cost option; see below.
If keys are cut, you must specify keymark and number of each marking.

DESCRIPTION	PATENTED
1AK SERIES	
Blanks	8.00
Operating-cut	18.90
Control, Master, SM or GM-cut	21.00
9AK SERIES	
Blockout blade & extractor key set	70.00

EXTRA COST OPTIONS*	
List price add-on per key blank (Note 2)	1.70

NOTE 1: One-time die stamping charge will be required. Pricing for special stamps and graphics are available upon request.
NOTE 2: Minimum 200 Keys Per Order



BEST Preferred Patented Keys

How To Order

1AF	1	1P	1	7	
Key Shape (Bow)	Key Type	Keyway	Cut Code	Pin Size	Options
1AF – Preferred Patented 9AF – Preferred Blockout Blade	0 – Blockout blade 1 – Operating 2 – Control 3 – Master 4 – Submaster 5 – Grandmaster 9 – Extractor key	1P 2P 7P 8P 9P 10P	1 – Blank 2 – Cut	7 – 7-pin (150 series 1CF cores only)	CS* – Custom stamp for key bow (Note 1)

*Indicates extra cost option; see below.

If keys are cut, you must specify keymark and number of each marking.

DESCRIPTION	PATENTED
1AF SERIES	
PATENTED blanks	8.30
Operating-cut	18.80
Control, Master, SM or GM-cut	22.00
9AF SERIES	
Blockout blade & extractor key set	69.00

EXTRA COST OPTIONS*	
List price add-on per key blank (Note 2)	1.70

NOTE 1: One-time die stamping charge will be required. Pricing for special stamps and graphics are available upon request.

NOTE 2: Minimum 200 Keys Per Order



BEST CORMAX™ Patented Keys

How To Order - M Series

1AM	1	MM	2	1	KS716	
Key Shape (Bow)	Key Type	Keyway	Level	Cut Code	Key Stamp	Options
1AM – M series key 2AM – Large round 3AM – Large rectangular 4AM – Access bow 9AM – Blockout blade	0 – Blockout blade 1 – Operating or blank 2 – Control 3 – Master 4 – Submaster 5 – Grandmaster 9 – Extractor key	MJ MK ML MM	1 – Non-exclusive 2 – Two-digit zip code exclusive 3 – One digit zip code exclusive 4 – National exclusive	1 – Blank 2 – Cut	KS716 - 1AM Front KS717 - 1AM Front KS800 - 1AM Back	B* – Long blade (1AM series only) H* – No hole (2AM series only) N* – Long nose (1AM series only) S* – Key serialization

*Indicates extra cost option; see below.
Designate multiple keyways if ordering a multi-milled key.
If keys are cut, you must specify keymark and number of each marking.
**Must specify keyway when ordering blockout blades

How To Order - X Series

1AX	1	X1	X	1	KS699	
Key Shape (Bow)	Key Type	Keyway	Level	Cut Code	Key Stamp	Options
1AX – X series key 9AX – Blockout blade	0 – Blockout blade 1 – Operating or blank 2 – Control 3 – Master 4 – Submaster 5 – Grandmaster 9 – Extractor key	X1..X32, etc.	W - Non-exclusive X - Two-digit zip code exclusive Y - One digit zip code exclusive Z - National exclusive	1 – Blank 2 – Cut	KS699 - 1AX Back	S* – Key serialization

*Indicates extra cost option; see below.
Designate multiple keyways if ordering a multi-milled key.
If keys are cut, you must specify keymark and number of each marking.
**Must specify keyway when ordering blockout blades

DESCRIPTION	PATENTED
1AM SERIES	
Blanks	5.20
Operating-cut	11.50
Control, Master, SM or GM-cut	12.60
1AX SERIES	
Blanks	5.20
Operating-cut	11.50
Control, Master, SM or GM-cut	12.60
2AM, 3AM & 4AM SERIES	
Blanks	5.40
Operating-cut	10.10
Control, Master SM or GM-cut	15.70
9AM & 9AX SERIES	
Blockout Blades	12.60
Extractor key (9AM9 or 9AX9)	12.60

EXTRA COST OPTIONS*	OPTION CODE	ADD-ON
Double milling	Specific Keyways	3.20
Quadruple milling		7.80
Long blade (1AM only)	B	3.20
No hole (2AM only)	H	2.10
Long nose (1AM only)	N	6.20
Key serialization / key	S	2.10

NOTES:

- 1: M Series key ways are backward compatible with STANDARD key ways of the same letter.
- 2: X Series key ways are NOT backward compatible.
- 3: Please contact factory for information regarding all security levels for the M and X Series. Levels 2, 3 and 4 require Masterkey Department authorization.
- 4: Match key keyways level to core key way level.
- 5: 3AM keys are available with M series keyways only



B Series Padlocks

How To Order

41B	7	2	L			
Shackle Diameter	Core Housing	Shackle Height	Function	Chain Option	Special Stamp No.	Options
11B – Brass 1/4" dia. 21B – Brass 5/16" dia. 41B – Brass 3/8" dia.	7 – 7-pin housing; accepts all BEST cores	Steel shackle 2 – 3/4" 21 – 1" w/ shroud (21B only) 22 – 1 1/2" 72 – 2" 82 – 4" Bronze shackle 0 – 3/4" 20 – 1 1/2" 70 – 2" 80 – 4"	T – Key retained L – Non-key retained	M – Case drilled for clevis only M1* – Bronze chain M5* – Galvanized steel chain M/CR* – Clevis Only	Blank – Best logo PS1010 – Safety first (11B & 21B) Specify PS# or describe stamp. Price for special stamps available upon request.	F3 – Frangible shackle (11B720 only) O* – Lockout/tagout S* – Car seal (41B only) ZZ* – Double lockout (11B only) XSPL* – Cut resistant shackle (21B & 41B only) WC* – Weather cover (21B & 41B only) SH – Shrouded padlock w/cut resistant shackle (21B only) 606* – Satin Brass finish (brass only)

*Indicates extra cost; see the last page of B Series.
Must specify keymark and number of keys or designate L/C for less core.

SHACKLE HEIGHT	SHACKLE CODE		COMPLETE WITH COMBINATED CORE			LESS CORE
	BRONZE	STEEL	PATENTED**	PREMIUM	STANDARD	
11B SERIES						
3/4"	0	2	122.00	123.00	112.00	51.00
1-1/2"	20	22	122.00	123.00	112.00	51.00
2"	70	72	125.00	126.00	115.00	54.00
4"	80	82	132.00	133.00	122.00	61.00
21B SERIES						
3/4"	0	2	123.00	124.00	113.00	52.00
1-1/2"	20	22	123.00	124.00	113.00	52.00
2"	70	72	126.00	127.00	116.00	55.00
4"	80	82	133.00	134.00	123.00	62.00
41B SERIES						
3/4"	0	2	125.00	126.00	115.00	54.00
1-1/2"	20	22	125.00	126.00	115.00	54.00
2"	70	72	128.00	129.00	118.00	57.00
4"	80	82	135.00	136.00	125.00	64.00
21B Series with Shroud*						
1"	N/A	21	172.00	173.00	162.00	101.00

*Pricing includes stainless steel shroud and cut-resistant shackle. Must include "SH" option when ordering

**Patented pricing shown is for CORMAX patented keying system. Add \$20.00 for BEST Preferred patented keying.

NOTE: 626 finish is standard on brass padlock series.



B Series Padlocks (continued)

DESCRIPTION	CATALOG NUMBER	COMPLETE WITH COMBINATED CORE			LESS CORE
		PATENTED	PREMIUM	STANDARD	
CABLE PADLOCKS					
Jacketed – 24" cable	21JB7-24T	143.00	144.00	133.00	72.00
Jacketed – 36" cable	21JB7-36T	150.00	151.00	140.00	79.00
Jacketed – 48" cable	21JB7-48T	157.00	158.00	147.00	86.00
Extra cable per ft. or fraction thereof jacketed	Add-On	7.60	7.60	7.60	7.60

EXTRA COST OPTIONS*	OPTION CODE	ADD-ON
Bronze chain	M1	9.10
Galvanized steel chain	M5	16.00
Lockout / tagout	O	12.00
Padlock weather covers (21B-41B only)	WC	6.30
Cut resistant shackle	XSPL	22.00
Car seal slot (41B only)	S	18.00
Satin Brass Finish	606	18.00
Double lockout safety (11B only)	ZZ	21.00
Clevis Only	M/CR	5.10

ACCESSORIES	CATALOG NUMBER	PRICE
Frangible shackle kit*	11B20FK	175.00
Frangible shackle only	11B20FF	9.10

REPAIRS	SERIES	PRICE
Includes all new parts, even a shackle, if necessary, but not a core or a new chain	11B	35.00
	21B	35.00
	41B	35.00

NOTE: Chain options are not available on cable padlocks or padlocks with shroud.

*Includes: padlock disassembly tool, three shackles and springs.



M1



M5

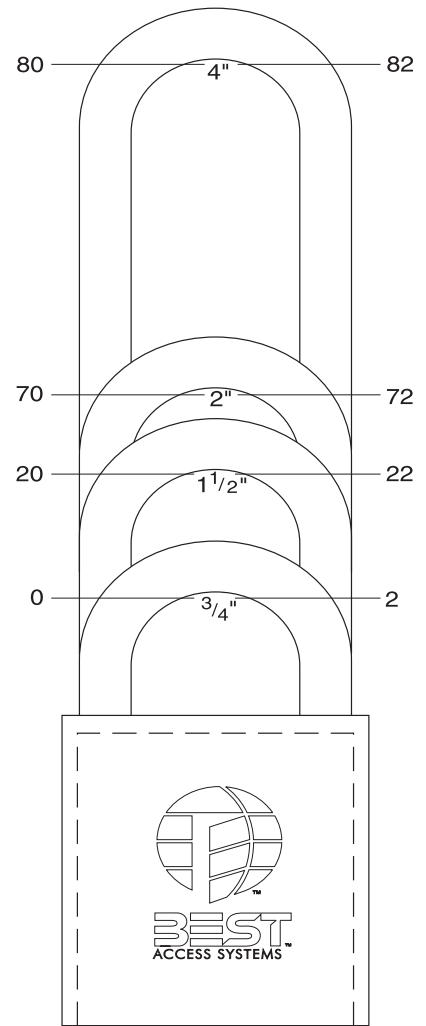



BEST Standard & Premium Cores

How To Order

1C	7	A	1		606
Core Type	Core Size	Keyway	Combining Code	Options	Finish
1C – Standard 1CD – Drill resistant 1CDP – Drill resistant Premium 1CP – Premium 2C** – Core for 8L mailbox 3C – Core for 8E cylinder 5C** – High security 6C – Core for 4S cylinders 6CP – Premium core for 4S cylinder	5 – 5-pin (1C only) 6 – 6-pin (1C only) 7 – 7-pin	Designate specific keyway (A, E, etc.)	1 – Uncombined 2 – Combined (B, W, P options)	B* – Pick & drill resistant (1CD only) K* – Key trap (1C only) P* – Pick resistant T* – Key retained (6C & 6CP only) W* – Wear resistant	605 606 611 612 613 625 626 690

*Indicates extra cost option; see below. **Requires long blade key.
If combined, you must specify keymark and number of keys.

DESCRIPTION	COMBINATING CODE	PREMIUM	STANDARD
1C & 1CP SERIES			
Uncombined	1	44.00	38.00
Combined	2	72.00	61.00
1CD & 1CDP SERIES			
Uncombined	1	63.00	57.00
Combined	2	91.00	80.00
2C & 3C SERIES			
Uncombined	1	N/A	40.00
Combined	2	N/A	63.00
5C SERIES			
Uncombined	1	N/A	55.00
Combined	2	N/A	73.00
6C & 6CP SERIES			
Uncombined	1	47.00	40.00
Combined	2	76.00	63.00

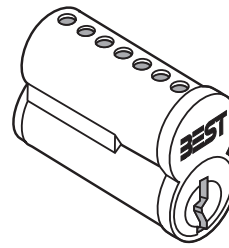

1C – 7-pin

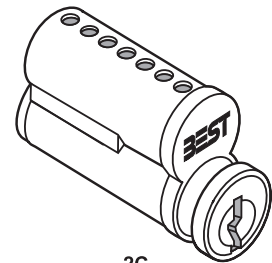

2C
(Requires long blade key)

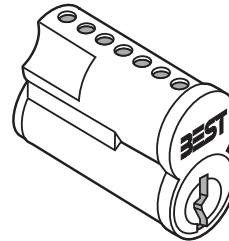

3C

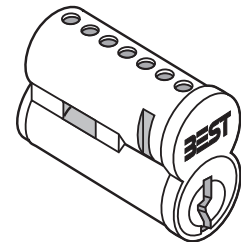

5C
(Requires long blade key)

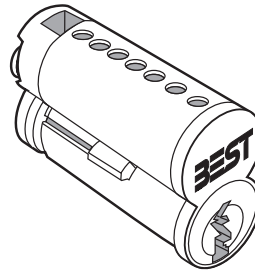

6C

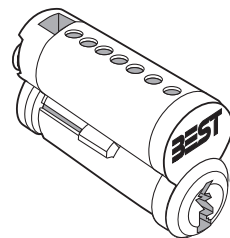

6CP

EXTRA COST OPTIONS*	OPTION CODE		ADD-ON
Pick &/or drill resistant	B,P	N/A	19.00
Key trap	K	N/A	8.70
Key retained	T	N/A	8.70
Wear resistant	W	N/A	8.70

PART DESCRIPTION	PART NO.	QUANTITY PER PKG.	PRICE PER PKG.
Standard pin segments	A0, A1 etc.	100	8.50
Spool pin segments (Note 1)	A6, A7, etc.	100	9.20
Stainless steel segments	A0, A1, etc.	100	44.00
Core caps (500 per pkg.)	21C	500	13.00
Core springs (500 per pkg.)	22S	500	32.00

NOTE: Standard spool pin segments are available in the following sizes: A6; A7; A8; A9; B8; B10; C3; C4; C5; C6; D6; D8; E3; E4; E5; F6; F7; & F8. (B6 spool pin segments should not be used with 5C core.)



BEST Peaks® Cores

How To Order

1CB	7	B1	1	626	
Core Type	Core Size	Keyway	Combining Code	Finish	Style
1CB – 150 Series 1CK – 140 Series	6 – 6-pin (140 & 150 series) 7 – 7-pin (150 series only)	B1 B6 B2 B7 B3 B10	1 – Uncombined 2 – Combined	626 – Simulated 606 – Simulated	3840 - BEST I/C 6 pin 140 series See the list below for other options.

*If combined, you must specify keymark and number of keys.

1CB SERIES PEAKS CORES

SERIES STYLE	DESCRIPTION	COMBINED	UNCOMBINED
INTERCHANGEABLE CORE			
3856	BEST I/C 6-pin brass 150 Series	88.00	51.00
3857	BEST I/C 7-pin brass 150 Series	88.00	51.00

1CK SERIES PEAKS CORES

SERIES STYLE	DESCRIPTION	COMBINED	UNCOMBINED
INTERCHANGEABLE CORE			
3840	BEST I/C 6-pin brass 140 Series	88.00	51.00
CONVENTIONAL CYLINDERS (KIK = Key in Knob)			
3404	Corbin Russwin CK4200 grade, 1 knob & UT5200 unit lock	107.00	68.00
3406	Arrow, LSDA, Schlage "06" kit includes 2 security bushings, 3 faced tailpieces	107.00	68.00
3408	Sargent 7, 8 & 9 line knob	107.00	68.00
3410	Sargent Kit for 6,10, 65 line and 2000 exit device line; includes security bushing and 2 fixed tailpieces (Use A and E bottom pins only)	107.00	68.00
3454	Yale 5300 grade 2 & 5400 grade 1 knob	107.00	68.00
3455	Corbin Russwin CL3900 & Yale 5400LN grade 1 lever	107.00	68.00
3476	Sargent 7600 Integra Lock	107.00	68.00
3495	Falcon, Sargent & Weiser cyl. kit for small dia. plug faces; 3 fixed & 3 lost motion tailpiece (Use J or K bottom pins only)	107.00	68.00
3499*	Peaks Universal "99" cyl. kit includes 3 fixed & 3 lost motion tailpieces (Use J or K bottom pins only)	107.00	68.00

*The 3499 universal cylinder should be used for all Key in Knob applications except Falcon, Sargent, Weiser Locks and specialty applications listed above. Refer to the BEST Peaks Technical Manual for various KIK Tailpiece Configurations.

REMOVABLE CORE			
6140	6-pin Corbin Russwin R/C	120.00	75.00
6240-6	6-pin Yale R/C	120.00	75.00
6240-7	6-pin for 7-pin housing Yale R/C	120.00	75.00
6340	6-pin Medeco R/C	120.00	75.00
6440	6-pin Schlage R/C	124.00	84.00
6540	6-pin Sargent R/C	120.00	75.00



BEST Preferred Patented Cores

How To Order

1CF	7	1P	1			626
Core Type	Core Size	Keyway	Combining Code	Style	Options	Finish
1CF - 150 Series Patented 3CF - Core for 8E Cylinder 150 Series 6CF - Core for 4S Cylinders 150 Series	6 - 6-pin (140 series only) 7 - 7-pin (150 series only)	1P 2P 7P 8P 9P 10P	1 - Uncombined 2 - Combined	See list below for style op- tions	(150 Series only) B* - Pick & drill resistant (1CDF only) K* - Key trap P* - Pick resistant T* - Key retained (6CF only) W* - Wear resistant D* - Drill Resistant	626** - Simu- lated 606** - Simu- lated 612 - Simulated 613 - Simulated

*Indicates extra cost option; see below
If combined, you must specify keymark and number of keys.

1CF, 1CDF, 3CF AND 6CF PREFERRED PATENTED CORES		
DESCRIPTION	COMBINED	UNCOMBINED
INTERCHANGEABLE CORE		
1CF - BEST Preferred I/C 7-pin brass 150 series	91.00	60.00
1CDF - BEST Preferred drill resistant I/C 7-pin brass 150 series	110.00	79.00
3CF - BEST Preferred I/C for 8E cylinder 7-pin brass 150 series	104.00	65.00
6CF - BEST Preferred I/C for 4S cylinder 7-pin brass 150 series	104.00	65.00

*The 3499 universal cylinder should be used for all Key in Knob applications except Falcon, Sargent, Weiser Locks and specialty applications listed above. Refer to the BEST Peaks Technical Manual for various KIK Tailpiece Configurations.

EXTRA COST OPTIONS	OPTION CODE	ADD-ON
Pick and/or drill resistant	B, D, P	19.00
Key Trap	K	8.70
Key Retained	T	8.70
Wear Resistant	W	8.70



BEST CORMAX™ Patented Cores

How To Order - M Series

1CM	7	MJ	3	1		626
Core Type	Core Size	Keyway	Level	Combining Code	Options	Finish
1CM – CORMAX Core M Series 1CDM – CORMAX Drill resistant 5CM*** – CORMAX for High security 6CM – CORMAX Core for 4S cylinder	6 – 6-pin 7 – 7-pin	MJ MK ML MM	1 – Non-exclusive 2 – Two-digit zip code exclusive 3 – One digit zip code exclusive 4 – National exclusive	1 – Uncombined 2 – Combined	B* – Pick & drill resistant (1CDM combined core only) K* – Key trap (1CM only) P* – Pick resistant T* – Key retained (6CM only) W* – Wear resistant	605 606 611 612 613 625 626 690

How To Order - X Series

1CX	7	X1	W	1		626
Core Type	Core Size	Keyway	Level	Combining Code	Options	Finish
1CX – CORMAX Core X Series 1CDX – CORMAX Drill resistant 6CX - CORMAX Core for 4S cylinder	6 – 6-pin 7 – 7-pin	X1..X32, etc.	W – Non-exclusive X – Two-digit zip code exclusive Y – One digit zip code exclusive Z – National exclusive	1 – Uncombined 2 – Combined (B Option)	B* – Pick & drill resistant (1CDX combined core only) P* – Pick resistant W* – Wear resistant	605 606 611 612 613 625 626 690

*Indicates extra cost option; see below
If combined, you must specify keymark and number of keys.

DESCRIPTION	COMBINATING CODE	CORMAX
1CM / 1CX SERIES		
Uncombined	1	51.00
Combined	2	71.00
1CDM / 1CDX SERIES		
Uncombined	1	70.00
Combined	2	90.00
5CM SERIES		
Uncombined	1	63.00
Combined	2	78.00
6CM SERIES		
Uncombined	1	54.00
Combined	2	72.00
6CX SERIES		
Uncombined	1	54.00
Combined	2	72.00

EXTRA COST OPTIONS*	OPTION CODE	ADD-ON
Pick &/or drill resistant	P & B	19.00
Key trap	K	8.70
Key retained	T	8.70
Wear resistant	W	8.70

NOTES

- 1: M Series key ways are backward compatible with Standard key ways of the same letter.
- 2: X Series key ways are NOT backward compatible.
- 3: Please contact factory for information regarding all security levels for the M and X Series. Levels 2, 3 and 4 require Masterkey Department authorization.
- 4: Match key keyways level to core key way level.

PART DESCRIPTION	PART NO.	QUANTITY PER PKG.	PRICE PER PKG.
Standard pin segments	A0, A1 etc.	100	8.50
Spool pin segments (Note 1)	A6, A7, etc.	100	9.20
Stainless steel segments	A0, A1, etc.	100	44.00
Core caps (500 per pkg.)	21C	500	13.00
Core springs (500 per pkg.)	22S	500	32.00

NOTE: Standard spool pin segments are available in the following sizes: A6; A7; A8; A9; B8; B10; C3; C4; C5; C6; D6; D8; E3; E4; E5; F6; F7; & F8. (B6 spool pin segments should not be used with 5C core.



D Series Service Equipment

The security items in this series are available only to registered BEST Masterkey System owners. The restriction is for the purpose of avoiding proliferation of equipment that could be used to compromise the security of such systems.

DESCRIPTION	CATALOG NO.	PRICE
AD SERIES - KEY EQUIPMENT		
Key combinator (Standard & CORMAX)	AD433*	4943.00
Key combinator—Premium	AD433P*	5675.00
Key carriage (Standard & CORMAX M Series keyways)	AD434	769.00
Key carriage—Premium	AD434P	640.00
Key combinator system conversion	Call to Order	636.00
Key cut indicator (in CD431 Kit)	AD501*	35.00
Key calibrator (mechanical)	AD502	791.00
Key calibrator (digital)	AD502D	2032.00
Key stamping plate (55 standard keys)	AD504A	1749.00
BD SERIES - PADLOCK EQUIPMENT		
Assembly kit complete	BD640	413.00
Tweezers—6" (in BD640 Kit)	BD641	23.00
Shackle plug tool (in BD640 Kit)	BD642	297.00
Holding plate (in BD640 Kit)	BD643	96.00
Rivet flaring tool	BD650	250.00
Storage hook (41B & 61B)	BD651	17.00
Padlock disassembly tool (11B, 21B, 41B)	BD654	174.00
Lockout	BD655	20.00
Lockout ties (pkg. of 50)	BD656A	32.00
Lockout name tag	BD657	6.60
Lockout / tagout	BD658	6.60
Corrosion free lubricant - 2 oz Squeeze Bottle	BD670	35.00
Corrosion free lubricant - 28.74 oz Refill	BD680	80.00
CD SERIES - CORE EQUIPMENT		
Combinating kit complete	CD431*	982.00
Combinating bin	CD433	394.00
Stamping plate—face only (87 cores)	CD504B	1749.00
Stamping plate—side only (50 cores)	CD504C	1749.00
Core capping / decapping press	CD517	2656.00
Graphite gun	CD535	30.00
Graphite—1 lb. container	CD535A	52.00
Capping / decapping block for 1C 150 (in CD431 Kit)	CD540	198.00
Hand capping pin for use with capping block (in CD431 Kit)	CD547	24.00
Ejector pin (in CD431 Kit)	CD548	17.00
Tweezers—3" (in CD431 Kit)	CD549	5.70
Combinating bin kit	CD435	1982.00
DD SERIES - COMBINATING EQUIPMENT		
Letter dies—1/16" or 3/32"	DD502	250.00
Number dies—1/16" or 3/32"	DD503	86.00
Core / key marking block (1 core & key)	DD513	198.00
Core / key marking plate (5 cores & 10 keys)	DD514	511.00
Magnetic strip (2 ea. in DD514)	DD514A	4.70
Combinating hammer with plastic head	DD550	118.00
Plastic heads (for DD550)	DD551	35.00

DESCRIPTION	CATALOG NO.	PRICE
ED SERIES - CYLINDER EQUIPMENT		
Mortise cylinder wrench	ED211	44.00
Mortise cylinder assembly tool	ED212	77.00
Thread repair die 1E cylinder	ED221	545.00
Cylinder cam testing tool	ED222	46.00
3E Cylinder hole tap	ED224	469.00
1E Cylinder hole tap	ED225	469.00
Eurocylinder wrench	ED801	160.00
5E Combinating kit complete (Note 1)	5ED250	1051.00
5E Thread tap—3/4" x 24	5ED253	210.00
5E Capping block (in 5ED250 Kit)	5ED261	307.00
5E Cap depressor (in 5ED250 Kit)	5ED262	83.00
5P Capping fixture	5PD655	665.00
KA SERIES - DOOR ADAPTOR KITS		
Mortise to cylindrical 1" faceplate	62KA2A	89.00
Mortise to cylindrical 1-1/8" faceplate	83KA2A	89.00
Wrap-around 2-3/8" backset (160)	62KA2B	89.00
Wrap-around 2-3/4" backset (161)	83KA2B	89.00
KD SERIES - CYLINDRICAL/TUBULAR EQUIPMENT		
9K Throughbolt drill jig	KD303	8.00
Boring jig kit complete (Note 3)	KD304A	1175.00
Drill bit—2-1/8"	KD308	394.00
Faceplate marking chisel (160)	KD312	106.00
Faceplate marking chisel (161) 1-1/8"	KD315	106.00
8K Spanner wrench	KD316	8.00
9K Spanner wrench	KD317	8.00
Drill bit—1" x 9"	KD318	86.00
Strike plate locating pin	KD325	35.00
Return spring loading tool	KD340	72.00
KNOB ADAPTATION CUT-OFF FIXTURES FOR:		
Schlage D Series	KD352S	202.00
Yale #5400	KD351Y	202.00

NOTES:

- 1: Specify A2, A3 or A4 keying system.
- 2: Specify door thickness (630 finish only).
- 3: KD304A includes a boring jig and a 3/8" adaptor chuck. (The boring jig and 3/8" adaptor chuck are not sold sperately).

*Specify A2, A3 or A4 keying system



D Series Service Equipment (continued)

The security items in this series are available only to registered BEST Masterkey System owners. The restriction is for the purpose of avoiding proliferation of equipment that could be used to compromise the security of such systems.

DESCRIPTION	CATALOG NO.	PRICE
140 SERIES BOTTOM PINS		
A2 Bottom pins (except for 6140, 6440, & 6540 RC, and KIK cylinders)	A2A0 thru A2A9	17.00
A2 Bottom pins for 6140 & 6540 RC, and KIK cylinders	A2J0 thru A2J9	17.00
A4 Bottom pins (except for 6140, 6440, & 6540 RC, and KIK cylinders)	A4E0 thru A4E5	17.00
A4 Bottom pins for 6140 & 6540 RC, and KIK cylinders	A4K0 thru A4K5	17.00
A2 Bottom pins for 6440 removable cores	A2X0 thru A2X9	17.00
140 SERIES TOP PINS		
A2 Top pins for all products (except 6440 removable core)	Use BEST top pins (see page 20)	N/A
A4 Top pins for all products (except 6440 removable core)	Use BEST top pins (see page 20)	N/A
A2 Top pins for 6440 removable core	A2W2 thru A2W19	17.00
PATENT TOP & BOTTOM PINS		
Patent top pins for all IC and RC cylinders	PT1	49.00
Patent top pins for KIK cylinders	PT2	49.00
Patent bottom pins (except for 6140, 6440, & 6540 RC, and KIK cylinders)	PB1	49.00
Patent bottom pins for 6140 & 6540 RC, and KIK cylinders	PB2	49.00
TIMING PINS		
Timing pin for 6340 and 6540 RC cylinders	TP6312	49.00
SEGMENT SPRINGS		
Springs for all products except Schlage 6440 RC	SS4220	67.00
Springs for Schlage 6440 RC	SS4010	67.00
SPRING SLIDE COVERS		
Spring cover for all KIK cylinders and 6440 RC	SC2000	49.00
Spring cover for 6140 & 6240 RC, mortise, and rim cylinders	SC2005	49.00
Spring cover for 6340 and 6540 RC cylinders	SC2001	49.00
Caps for 3840 IC core	Use BEST 21C caps (see page 20)	N/A
CAPPING TOOLS		
Staking fixture for KIK, mortise, and rim cylinders	CD4000	520.00
Staking fixture for IC, and all RC cylinders (except 6440 RC)	CD6840	520.00
Staking tool for KIK, and all RC cylinders (except 6440 RC)	CD4001	244.00
Staking fixture for 6440 RC cylinder	CD6440	260.00
Staking tool for 6440 RC cylinder	CD6401	244.00
Plug follower	CD4003	42.00
140 & 150 key gage for both A2 and A4	AD4050	66.00
PIN KITS		
Peaks universal A2 pin kit complete (Manufactured by KABA)	CD5012	1328.00
Peaks universal A4 pin kit complete (Manufactured by KABA)	CD5004	1328.00
Peaks Schlage 6440 RC A2 pin kit complete (Manufactured by KABA)	CD5002	1328.00
AD SERIES - KEY EQUIPMENT (You must purchase directly from Best)		
Key combinator – Peaks® 6-pin	AD436*	6019.00
Key combinator – Peaks® 7-pin	AD437*	6019.00
Key carriage – Peaks® 6-pin	AD436K	998.00
Key carriage – Peaks® 7-pin	AD437K	998.00
CAPPING TOOLS (You must purchase directly from Best)		
140 Series IC Capper/Decapper press	CD517P	2614.00
140 IC Capping block only (order CD540 for 150 IC)	CD540P	195.00
140 & 150 Key cut indicator (Peaks equipment)	AD4050	66.00
140 & 150 IC Capping tool (for use with capping block)	CD547	24.00

All 140 Series keys and 150 Series keys using B3 through B6 keyways require a key milling machine.

*Specify A2 or A4 keying system.



KRD Series Key Retaining Devices

How To Order

KRD-2	UL-KRD-2	S
Device type	Part number	Option

DESCRIPTION	CATALOG NUMBER	PRICE
BEST core models		
KRD-2 BEST Core Model	UL-KRD-2	428.00
KRD-2H Hybrid (Sargent/BEST Model)	UL-KRD-2H SAR/BEST	491.00
KRD-2H Hybrid (BEST/Schlage FSIC Model)	UL-KRD-2H BEST/SCH	491.00
KRD-3 BEST Core Dual Function Model	UL-KRD-3	635.00
Non-BEST Full size core models		
KRD-2 Corbin Russwin 6-pin IC	UL-CR6-KRD-2	491.00
KRD-2 Corbin Russwin 7-pin IC	UL-CR7-KRD-2	491.00
KRD-2 Medeco IC	UL-MED-KRD-2	491.00
KRD-2 Sargent RC	UL-SAR-KRD-2	491.00
KRD-2 Schlage FSIC	UL-SCH-KRD-2	491.00
KRD-2 Yale 6-pin IC	UL-YA6-KRD-2	491.00
KRD-2 Yale 7-pin IC	UL-YA7-KRD-2	491.00

EXTRA COST OPTIONS*	OPTION CODE	ADD-ON
Switch	S	151.00
Security seal	SS	135.00

*Add option code to part number shown above.



QU-I.C-SYSTEM Combining Tool Packages

How To Order

	BQDP	A2	7	Example: GM 8301836 CTL 4189250
	Package description	System Type	Core size	System Code Information REQUIREMENT
Dedicated	BQDP – Basic QU-I.C-KEY Dedicated Package PQDP – Professional QU-I.C-KEY Dedicated Package	A2 – A2 System A4 – A4 System	6 – 6-pin 7 – 7-pin	YES System Grand Master and Control codes must be supplied
Universal	BQUP – Basic QU-I.C-KEY Universal Package PQUP – Professional QU-I.C-KEY Universal Package	A2 – A2 System A4 – A4 System	6 – 6-pin 7 – 7-pin	NO Code information is not necessary.

DESCRIPTION	CATALOG NO.	PRICE
Dedicated Packages		
These QU-I.C-KEYS are permanently factory built specifically for just one key system. Grand master & Control codes are required. These tools are intended for long-term use by Institutional Locksmiths and others who continuously work with the same key system(s).		
Basic dedicated package, includes: QKD, QLT-6 or QLT-7, QTT, QCT, QTJ, and QPT (see individual components listed below).	BQDP-A2/A4-pin/GM & CTL *	1671
Professional dedicated package, includes all components in the basic package, plus QTA, QPP and CKT-80 (see individual components listed below).	PQDP-A2/A4-pin/GM & CTL *	2090
Universal Packages		
Using a blank QU-I.C-KEY and code strips, you get to custom build a QU-I.C-KEY for any A2 key system that you are working with. These kits are better suited for temporary use and re-use - not for longer term of continuous key system use. A4 System kits are also available.		
Basic universal package, includes: QKD, QLT-6 or QLT-7, QTT, QCT, QTJ, and QPT (see individual components listed below).	BQUP-A2/A4-pin *	2093
Professional universal package, includes all components in the basic package, plus QPP, QTA and CKT-80 (see individual components listed below).	PQUP-A2/A4-pin *	2507
Individual Components		
Dedicated QU-I.C-KEY with viewing base (system information required)	QKD-A2/A4-pin/GM & CTL	538
Dedicated QU-I.C-KEY tool only (system information required)	QKDT-A2/A4-pin/GM & CTL	406
Universal QU-I.C-KEY with viewing base (specify A2 or A4 system)	QKU-A2/A4	996
QU-I.C-LOAD tool (specify 6 or 7-pin cores)	QLT-6 * or QLT-7 *	413
QU-I.C-TEST tool	QTT *	571
QU-I.C-CHEX Tool	QCT *	95
QU-I.C-Tweez-jector	QTJ	153
QU-I.C-Preamer	QPT	129
QU-I.C-Power preamer	QPP	95
QU-I.C-TEST Adapter (must be used with QTT)	QTA	217
12 Position Core & key tray	CKT-12	186
80 Position Core & key tray	CKT-80	388

*Not compatible with the special 140 Series.



E Series Cylinders

How To Order

1E	7	4		C4	RP3	626
Series	Core Housing	Function Code	Length Code	Cam or Spindle	Rings	Finish
See Below***	0 – Dummy 6 – 6-pin 7 – 7-pin housing; accepts all BEST cores	See below	Blank – Standard 22 – 1-3/8" 24 – 1-1/2" up to 6" (See length code below)	C4 – Standard cam C181 – Adams Rite MS cam S2 – Standard spindle For a complete list of cams, see the next page.	RP – Rim cylinder RP1 – Tapered cylinder RP2 – 6-pin mortise RP3 – 7-pin mortise RP4 – 3E mortise RP5 – 7-pin mortise For special rings, see the catalog.	626 690 Satin* 606 612 613 619 Bright* 605 611 625

*Indicates extra cost; see below.

Must specify keymark and number of keys or designate L/C for less core.

***1E Special Lengths only available on 1E4 7-Pin

SERIES/DESCRIPTION	FUNCTION OR LENGTH CODE	COMPLETE WITH COMBINATED CORE			LESS CORE
		PATENTED*	PREMIUM	STANDARD	
1-5/32" DIAMETER CYLINDERS					
12E Standard rim	2	126.00	127.00	116.00	55.00
1E Standard mortise Tapered mortise Dummy rim / mortise (0-pin**)	4	135.00	136.00	125.00	64.00
	6	135.00	136.00	125.00	64.00
	02/04	N/A	N/A	N/A	34.00
1EA Turn knob-rim / mortise (6-pin**)	A2/A4	N/A	N/A	N/A	47.00
1EB Rim / mortise with dust cover	B2/B4	168.00	169.00	158.00	97.00
1EC Square head mortise	C4	168.00	169.00	158.00	97.00
1ED Slabbed direct motion (7-pin**)	D4	168.00	169.00	158.00	97.00
1EE Slabbed lost motion (7-pin**) (Specify RH or LH hand.)	E4	168.00	169.00	158.00	97.00
1EF Standard lost motion (Note 1)	F4	168.00	169.00	158.00	97.00
1EG Hotel shifting cam	G4	168.00	169.00	158.00	97.00
1EJ High security—UL-listed (7-pin**)	J4	248.00	N/A	241.00	N/A
1EK High security—Non-UL (7-pin**)	K4	163.00	N/A	158.00	168.00
1E SERIES SPECIAL LENGTH MORTISE CYLINDERS					
1-3/8"	22	157.00	158.00	147.00	86.00
Each additional 1/8" (1-1/2" to 6") See catalog for lengths available.	24 to 96	4.10	4.10	4.10	4.10
3E SERIES					
Mortise-1-1/2" diameter (7-pin**)	4	168.00	169.00	158.00	97.00

LENGTH CODE	CYLINDER LENGTH
22	1 3/8"
24	1 1/2"
26	1 5/8"
28	1 3/4"
30	1 7/8"
32	2"
34	2 1/8"
36	2 1/4"
40	2 1/2"
44	2 3/4"
48	3"
56	3 1/2"
64	4"
72	4 1/2"
80	5"
88	5 1/2"
92	5 3/4"
94	5 7/8"
96	6"

*Patented pricing shown is for CORMAX patented keying. Add \$20.00 for BEST Preferred patented keying.

**Only Standard and CORMAX M Series keying available on 1EJ and 1EK cylinders.

*EXTRA COST OPTION	ADD-ON
Satin finish—606, 612, 613, etc.	3.80
Bright finish—605, 611, 625, etc.	5.40

PART DESCRIPTION	PART NUMBER	PART PRICE	WITH LOCK ADD-ON
Cams	1EC4, etc.	4.60	0.00
Standard rings	1ER2, 3, 4, 5	4.10	0.00
Straight rings (Specify lengths.)	1ER7	15.00	6.20
Tapered rings (Specify lengths.)	1ER8	19.00	14.00
Security rings (Specify lengths.)	1ESR	62.00	0.00
Spindles	1ES2, 3	4.10	0.00
Hex nut for 1E	A00836	3.70	0.00
Standard throw pins	A40095	0.80	0.00
Throw pins—Adams Rite MS Cam	A20924	0.80	0.00

NOTE 1: Specify stop pin right or left of cam from back view.



E Series Cylinders (continued)

Use the following table to determine the kinds of cams available for 1E, 3E and 5E cylinders.

CAMS LISTING

Cam Type	Cams by Cylinder Type		
	1E Cyl	3E Cyl	5E Cyl
Cabinet	C224 C225 C228 C229 C235 C238 C241 C246 C248 C249 C250 C253 C500 thru C509 (C500, C501, C502, etc) A04607 A08854 A10281 A14154		C2A C245 C4A C3 C2B C4B A10281 A21198 A26344
Cloverleaf	C118 C161 C204 C222 C243 C254 C256 C258 C265 C281	C118 C161	
Roller	C142 C221 C227 C240 C251 A04533	A04533	
Straight	C101 C103 C110 C115 C121 C123 C124 C127 C128 C129 C130 C131 C134 C136 C137 C143 C148 C152 C162 C165 C169 C171 C173 C177 C178 C179 C181 C182 C185 C186 C187 C191 C193 C200 C203 C208 C209 C210 C211 C220 C223 C226 C231 C233 C234 C239 C242 C247 C252 C4	C127 C136 C208 C210 C3 C4	
Thumbturn	C140 C410 thru (C401, C402, etc)		
Two-point	C102 C114		



5E and 8E Series Utility Cylinders (Cam Locks)

How To Order

5E	7	A	1	C	R708	4B	21	12	R	90	626
Series	Lock Body	Keyway	Combining Code	Cam Motion	Ring Length	Cam Type*	Cam Length	Mounting Position	Cam Direction	Degree of Rotation	Finish
5E – 3/4"	6 – 6-pin 7 – 7-pin	Designate specific keyway (A, E, etc.)**	1 – Uncombined 2 – Combined	A – Direct B – Limited C – Lost motion D – Throw member drive	R701 – 1/16" R702 – 1/8" R703 – 3/16" R704 – 1/4" R705 – 5/16" R706 – 3/8" R707 – 7/16" R708 – 1/2" etc.	1 – Fixed Straight 2A – Fixed offset in 2B – Fixed offset out 3 – Lost motion 4A – Lost motion offset in 4B – Lost motion offset out D – Direct throw member	10 – 5/8" 12 – 3/4" 14 – 7/8" 16 – 1" and so forth in 16ths of an inch	3 – 3 o'clock 6 – 6 o'clock 9 – 9 o'clock 12 – 12 o'clock	R – Right L – Left	90 – 90° 180 – 180° 360 – 360°	626 Only

*See the previous page for other compatible 5E cams.

If combined, you must specify keymark and number of keys.

**5E cylinders available in Standard and Premium keyways only.

DESCRIPTION	COMBINATING CODE	PRICE COMPLETE
5E—Uncombined	1	61.00
5E—Combined	2	81.00

PART DESCRIPTION	PART NUMBER	PART PRICE
Cams	5EC1, etc.	4.90
Slide cap—6-pin	5ECP6	1.00
Slide cap—7-pin	5ECP7	1.00
Cam screws	5ECS	2.10
Hex nut 3/4"	5EH	4.10
Cam screw lock washer	5ELW	2.10
Rings (Specify length.)	5ER7	5.70
Springs (box of 500)	5ES1	33.00
Lock body washer	5EW	2.10

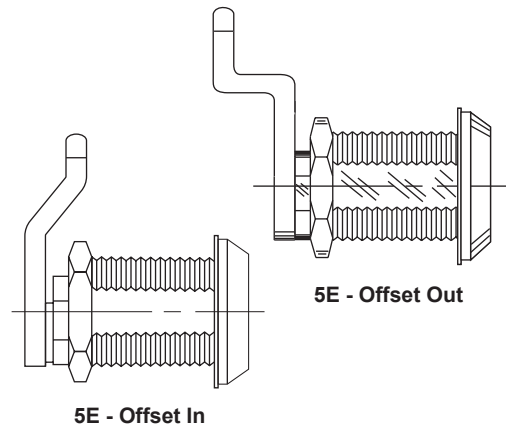

DESCRIPTION	CATALOG NUMBER	COMPLETE WITH COMBINATED CORE			LESS CORE
		PATENTED*	PREMIUM	STANDARD	
8E SERIES EUROCYLINDERS					
Single cylinder—elliptical***	8EA7A5	N/A	N/A	150.00	87.00
Double cylinder—elliptical***	8EA7A6	N/A	N/A	230.00	104.00
Single cylinder—profile****	8EE7E4	N/A	N/A	231.00	168.00
Double cylinder—profile****	8EE7E5	N/A	N/A	306.00	180.00
Cylinder x turn knob—profile*****	8EE7E8	N/A	N/A	231.00	168.00
Union single cylinder*****	8EH7H5	208.00	209.00	198.00	137.00
Union double cylinder*****	8EH7H6	319.00	321.00	299.00	177.00
Union cylinder x turn knob*****	8EH7H7	226.00	227.00	216.00	155.00
Union cylinder x lever turn*****	8EH7H8	283.00	284.00	273.00	212.00

ATTENTION: Locksets that secure both sides of the door are controlled by building codes and the Life Safety Code. Delay in unlocking for rapid emergency exit could be hazardous or even fatal.

*To order 8EE7E5, you must specify the ring length and critical dimensions. Refer to the catalog section "Cylinders."

**Patented pricing shown is for CORMAX patented keying system. Add \$20.00 for BEST preferred patented keying.

***Available in 605,606,619,625,626 finishes

****Available in 606,613,619,626 finishes

*****Available in 606,625,626 finishes



Keystone® Web

DESCRIPTION	PRODUCT NUMBER	LIST PRICE
Keystone Web – New License	KSWN	4000.00
Keystone Web – Upgrade (For existing users with keystone software)	KSWUP	2000.00

DESCRIPTION	PRODUCT NUMBER	LIST PRICE
New System Import – Importing code files for a new system	IMPKSW-1	800.00
Additions Import * – Importing code files for additions to existing system (Imports of less than 10 masters)	IMPKSW-2	200.00

*Any additions import consisting of more than 10 masters will require IMPKSW-1
 The import pricing is without respect to how many individual masterkey systems or code files are imported
 Every import order must be accompanied by an import order form. The import form is located on bestaccess.com under Keystone web resources or ask your BEST Access Solutions sales representatives for a copy.

Notes: Keystone Web software will support both network and standalone installations
 Keystone Web comes without any information loaded. Code Import files have to be ordered to import code data
 For existing customers, migration tool is included with the software to migrate data into the new application during upgrade.
 There is no additional charge for migrating existing user data in older version of Keystone to Keystone Web.
 All orders will require following information: End User Company/Facility Name, End User Name, End User Email.



45H Series Mortise Locks

Federal Spec. 86

ANSI Series 1000

How To Order

45H	7	R	14	H	626	RH	
Series	Core Housing	Function Code	Lever Style	Trim Style	Finish	Door Hand	Options
45H – Standard mortise lock	0** – Less cylinder (non-keyed or dummy trim) 7 – 7-pin housing accepts all BEST cores	A – Office D – Storeroom L – Privacy N – Passage R – Classroom T – Dormitory etc. See below	3 – Solid tube/return 12* – Solid tube/no return 14 – Curved/return 15 – Contour/angle return 16 – Curved/no return 17R* – Gull wing RH 17L* – Gull wing LH Knobs: 4 – Round Decorative* 50-91 OEM**** - Service (less lever)**	H – 2-3/4" dia. R – 2-3/4" dia. S – 3-1/2" dia J* – wrought M* – forged N* – forged (concealed cylinder; N trim invalid on non-keyed and double keyed functions)	618 626 630*** 690 622 626AM* 630AM* Satin* 606 612 613 619 Bright* 605 611 625 629***	RH RHR LH LHR	7/8"* – 7/8" lip-to-center strike LL* – Lead lined MNT* – Mounted sample SH* – Security head screws Thick Door* – Specify thickness if other than 1-3/4" TAC/B* – Tactile both levers/knobs TAC/O* – Tactile outside lever/knob TAC/I* – Tactile inside lever/knob VIN* – Visual Keyed Indicator Option VIT* - Visual Thumb-Turn Indicator Option VIB* -Double Visual Indicator Option VT* - Vandal Trim WS – Windstorm Label (NOA Miami-Dade County)

*Indicates extra cost option

**Indicates cost deduction. Must specify keymark and number of keys or designate L/C for less core.

Note: VIN option only compatible with H, R and J trim styles

VIT options only compatible with H, R, S, J & M trim styles

VIB option only compatible with H, R & J trim styles

OEM option is only compatible with H, R and S Trim Styles.

Decorative levers are considered special order items that may have extended lead times. Consult factory for lead times.

Available decorative levers: 50-53, 55, 60, 62-63, 65, 69, 75, 79-81, and 89

FUNCTION DESCRIPTION	FUNCTION CODE	COMPLETE WITH COMBINATED CORE			LESS CORE
		PATENTED*	PREMIUM	STANDARD	
Single Keyed:					
Latch	A, AT, D, R	851.00	852.00	841.00	780.00
Deadbolt	AB, B, BA, BW, T, TA, TD	875.00	876.00	865.00	804.00
Holdback	RHB	866.00	867.00	856.00	795.00
Hotel	H, HJ	N/A	N/A	963.00	902.00
Deadlock	AD, YD	384.00	385.00	374.00	313.00
Deadlock-Classroom	RD	432.00	433.00	422.00	361.00
Double Keyed:					
Latch	C, INL, W	992.00	994.00	972.00	850.00
Deadbolt	G, IND, S, INA	1018.00	1020.00	998.00	876.00
Holdback	CHB	1018.00	1020.00	998.00	876.00
Deadlock	WD	524.00	526.00	504.00	382.00
Keyless:					
Passage	N	N/A	N/A	N/A	616.00
Privacy (Latch)	LT	N/A	N/A	N/A	709.00
Privacy (Deadbolt)	L, LB	N/A	N/A	N/A	729.00
Exit	NX	N/A	N/A	N/A	709.00
Single Dummy	1DT	N/A	N/A	N/A	267.00
Double Dummy	2DT	N/A	N/A	N/A	475.00
Universal Functions					
Latch	UNR	850.00	851.00	840.00	779.00
Deadbolt	UNT, UNAB	866.00	867.00	856.00	795.00

*Patented pricing show is for CORMAX patented keying. Add \$20.00 for BEST Preferred patented keying.

Note: 47H Series must be keyed at the factory unless the K option is ordered.



45H Series Mortise Locks (continued)

EXTRA COST OPTIONS*	OPTION CODE	PER LOCK
Satin finishes (per lock)	606, 612, 613, 619 etc.	29.00
Bright finishes (per lock)	605, 611, 625, etc.	56.00
UltraShield antimicrobial finish	626AM, 630AM	58.00
Wrought trim	J	11.00
Thick door	Specify thickness	81.00
Tactile both levers/knobs^	TAC/B	115.00
Tactile outside lever/knob^	TAC/O	58.00
Tactile inside lever/knob^	TAC/I	58.00
Lead lined	LL	224.00
Forged trim	M, N	90.00
Security head screws	SH	21.00
7/8" Lip-to-center strike	7/8 LTC	21.00
Mounted Samples	MNT	Quote
Vandal trim - 630 finish^	VT	143.00
Vandal trim - other finishes^	VT	109.00
Visual Indicator^	VIN	42.00
Visual Indicator Thumb-Turn	VIT	66.00
Double Visual Indicator	VIB	108.00
12, 17 Lever Design	12, 17	63.00
Decorative Lever Design	50-53, 55, 60, etc.	202.00
COST DEDUCTIONS**	OPTION CODE	DEDUCT
Less cylinder option (Deduct from complete price)	0	61.00
OEM - Service (Less lever/trim)^	OEM	28.00

*Indicates extra cost option.

**Indicates cost deduction. Must specify keymark and number of keys or designate L/C for less core.

^Note:

TAC/B, TAC/O, TAC/I options not available on #17 levers.

Vandal trim option available only with #14 and #15 levers. Only #14 lever complies with California State Fire Marshal Code.

VIN option only compatible with H, R and J Trim Styles.

OEM Service: The Stanley BHMA listed lock with trim from another manufacturer in this price book is not being offered as a BHMA listed product. Stanley cannot ensure the compatibility of our lock with any third party product and such products have not been tested as a combined unit. Please see Stanley warranty for further details.



47H Series High Security Mortise Lock

Federal Spec. 86

ANSI Series 1000

How To Order

47H	7	R	14	M	626	RH	
Series	Core Housing	Function Code	Lever Style	Trim Style	Finish	Door Hand	Options
47H – Lever/ Knob - High Security mortise lock	7 – 7-pin housing accepts 5C core only	A – Office D – Storeroom R – Classroom T – Dormitory etc.	Levers: 3 – Solid tube/return 12* – Solid tube/no return 14 – Curved/return 15 – Contour/angle return 16 – Curved/no return 17* – Gull wing Knobs: 4 – Round Decorative* 50–91	H*** – 2-3/4" dia R*** – 2-3/4" dia S*** – 3-1/2" dia M – Forged	626 630 626AM* 630AM*	RH RHR LH LHR	7/8"* – 7/8" Lip-to-center strike K – Non UL cylinder LL* – Lead lined TAC/B* – Tactile both levers/knobs TAC/O* – Tactile outside lever/knob TAC/I* – Tactile inside lever/knob Thick Door* – specify thickness if other than 1 3/4" VT* – Vandal Trim WS – Windstorm Label (NOA Miami-Dade County)

EXTRA COST OPTIONS* See 45H section.

** Indicates cost deduction; see 45H section. Must specify keymark and number of keys.

***To maintain the UL437 standard for high security locks, order only M trim. Using H, R or S trim does not meet the UL437 standard.

FUNCTION DESCRIPTION	FUNCTION CODE	PATENTED*	STANDARD
Single Keyed:			
Latch	A, AT, D, R	1040.00	1035.00
Deadbolt	AB, B, BA, BW, T, TA, TD	1070.00	1065.00
Deadlock	AD, YD	648.00	643.00
Deadlock-Classroom	RD	699.00	694.00
Double Keyed:			
Latch	C, INL, W	1271.00	1261.00
Deadbolt	G, IND, S, INA	1308.00	1298.00
Deadlock	WD	890.00	880.00

*Pricing reflects the 5C high security core for standard, and the 5CM high security CORMAX core for patented.



48H and 49H Series Mortise Deadlocks

How To Order

48H	7	K	626	Options
Series	Core Housing	Function Code	Finish	
48H – Standard 49H** – High security	0 – Less cylinder (48H only) 7 – 7-pin housing 48H accepts all BEST cores 49H accepts 5C core only	See below	622 626 690 626AM* Satin* 606 612 613 619 Bright* 605 611 618 625 49H 626 630	K – 1E7K4 high security cylinder (non UL) for 49H only LL* – Lead lined SH* – Security head screws Thick Door* – Specify thickness if other than 1-3/4” RH - Specify for R function LH - Specify for R function (R functions handling must be specified) WS – Windstorm Label (NOA Miami-Dade County)

*Indicates extra cost option; see below.
 **49H is keyed at the factory unless the K option is ordered.
 Note: Must specify keymark and number of keys or designate L/C for less core.
 Security Head screws provided standard on 49H.

FUNCTION DESCRIPTION	FUNCTION CODE	COMPLETE WITH COMBINED CORE			LESS CORE
		PATENTED*	PREMIUM	STANDARD	
48H SERIES					
Single cylinder	K, L	381.00	382.00	371.00	310.00
Single cylinder - Classroom	R	427.00	428.00	417.00	356.00
Double cylinder	M	516.00	518.00	496.00	374.00
49H SERIES					
Single cylinder	K, L	723.00	N/A	718.00	N/A
Single cylinder-Classroom	R	774.00	N/A	769.00	N/A
Double cylinder	M	867.00	N/A	862.00	N/A

*For 48H, patented pricing shown is for CORMAX M series patented keying system only. Add \$20.00 for BEST Preferred Keying.
 For 49H, pricing reflects the 5C high security core for standard and the 5CM high security CORMAX core for patented.

EXTRA COST OPTIONS*	OPTION CODE	ADD-ON
Satin finishes	606, 612, 613, etc.	29.00
Bright finishes	605, 611, 625, etc.	56.00
UltraShield antimicrobial finish	626AM, 630AM	58.00
Security head screws (48H)	SH	21.00
Thick door (48H only)	Specify thickness	81.00
Lead lined	LL	224.00



40H Series Mortise Components

Federal Spec. 86

ANSI Series 1000

How To Order Case Only

45HCA	R	626	
Series	Function Code	Finish	Options
45HCA - Mortise lock case only	A - Office D - Storeroom R - Classroom T - Dormitory etc.	626 630 622 690 626AM* 630AM* Satin* 606 612 613 619 618 Bright* 605 611 625 629	SH* - Security head screws 7/8" - 7/8" Lip-to-center strike (Handling): RH LH RHR LHR

*Indicates extra cost option.

How To Order Trim Kits

40HTK	OS2	14	H	626	
Series	Function Code	Knob/Lever Style	Trim Style	Finish	Options
40HTK - Trim Kit	IS1 - inside lever only IS2 - inside lever x turn IS3 - inside lever x cyl IS4 - inside cyl only IS5 - inside turn only*** IS6 - inside lever x cylinder x visual indicator OS1 - outside lever only OS2 - outside lever x cyl OS3 - outside lever/ emergency plate OS4 - outside cyl only OS5 - outside lever x visual indicator OS6 - outside lever x cylinder x visual indicator	Levers: 3-solid tube/return 12* - Solid tube/no return 14-curved return 15-contour/angle return 16-curve/no return 17-RH* 17-LH* 50-91 - Decorative* Knobs: 4-round	H-2-3/8" dia. R-2-3/4" dia. S-3-1/2" dia J*-wrought M*-forged N*-forged (concealed cylinder)	605* 606* 611* 612* 613* 618* 619* 622 625* 626 629 630 690 626AM* 630AM*	Thick Door* (specify thickness if other than 1 3/4") SH* - Security head screws TAC/O* - Tactile outside lever/knob TAC/I* - Tactile inside lever/knob

***Does not include lever - Unavailable with J trim.

45HCA CASE ONLY:		
FUNCTION DESCRIPTION	FUNCTION CODE	PRICE
Single Keyed:		
Latch	A, AT, D, R	331.00
Deadbolt	AB, B, BA, BW, T, TA, TD	360.00
Holdback	RHB	339.00
Hotel	H, HJ	360.00
Deadlock	AD, YD	228.00
Deadlock-Classroom	RD	209.00
Double Keyed:		
Latch	C, INL, W	331.00
Deadbolt	G, IND, S, INA	360.00
Holdback	CHB	339.00
Deadlock	WD	228.00
Keyless:		
Passage	N	258.00
Privacy (Latch)	LT	331.00
Privacy (Deadbolt)	L, LB	360.00
Exit	NX	331.00
Universal Functions		
Latch	UNR	331.00
Deadbolt	UNT, UNAB	360.00

Price includes lock case, faceplate and strike package. Refer to 45H for complete mortise cylinder pricing.

Vandal Trim Retrofit Kit

SERIES	LEVER STYLE	FINISH	OPTIONS
45HVTK - Vandal Trim Kit	14* - curved return 15 - contour / angle return	605, 606, 611, 612, 613, 618, 619, 622, 625, 626, 629, 630, 690	Thick door (specify thickness if other than 1 3/4")

TRIM ONLY:	
KIT NUMBER	PRICE
IS1 - Inside lever only	182.00
IS2 - Inside lever x turn	241.00
IS3 - Inside lever x cylinder	261.00
IS4 - Inside cylinder only	73.00
IS5 - Inside turn only	63.00
IS6 - Inside lever x cylinder x visual indicator	303.00
OS1 - Outside lever only	202.00
OS2 - Outside lever x cylinder	271.00
OS3 - Outside lever x emergency plate	212.00
OS4-Outside cylinder only	73.00
OS5-Outside lever x Visual Indicator	244.00
OS6-Outside lever x cylinder x visual indicator	313.00

EXTRA COST OPTIONS*	OPTION CODE	ADD-ON
Satin finishes	606, 612, 613, etc.	29.00
Bright finishes	605, 611, 625, etc.	56.00
UltraShield antimicrobial finish	626AM, 630AM	58.00
J Trim	J	11.00
Forged trim	M, N	90.00
Thick Door	Specify Thickness	81.00
Security head screws	SH	21.00
7/8" Lip-to-center strike	7/8" LTC	21.00
Tactile outside lever/knob**	TAC/O	58.00
Tactile inside lever/knob**	TAC/I	58.00
12, 17 Lever Design	12, 17	31.50
Decorative Lever Design	50 to 91	101.50

VANDAL TRIM KIT FINISH	PRICE
630	150.00
All others	114.00

** Not available on #17 levers.



40H Strike Packages

Federal Spec. 86

ANSI Series 1000

How To Order

40HST	1	626	
Series	Kit number	Finishes	Options
40HST – Strike package	1 – Standard 4 - Strike Box Only 5 – Latchbolt only 6 – Latchbolt/deadbolt	605 606 611 612 613 618 619 622 625 626 629 630 690	Thick Door* – (specify thickness if other than 1-3/4") 7/8"* – 7/8" lip-to-center strike SH* – Security head screws RH - Handing (required for 5,6 kit) LH - Handing (required for 5,6 kit)

*Indicates extra cost option.

PART DESCRIPTION	PART NUMBER	PARTS PRICE
STRIKE PACKAGES		
Standard strike package	40HST-1-626	34.00
Latchbolt-only strike package	40HST-6-626-RH	38.00
Latchbolt/deadbolt strike package	40HST-6-626-LH	38.00
STRIKE PACKAGES		
Plastic strike box	40HST-4	2.20
Wrought steel strike box	3126903	6.10

EXTRA COST OPTIONS*	OPTION CODE	ADD-ON
Thick door	Specify thickness	21.00
7/8" Lip-to-center strike	7/8" LTC	21.00
Security head screws	SH	21.00

40H Lever Sets

How To Order

40HLS	14	626	
Series	Knob/lever style	Finishes	Options
40HLS – Lever set	Levers: 3 – Solid tube/return 12* – Solid tube/no return 14 – Curved/return 15 – Contour/angle return 16 – Curved/no return 17* RH – Gull wing right hand 17* LH – Gull wing left hand 50-91 – Decorative* Knobs: 4 – Round	605 606 611 612 613 618 619 622 625 626 629 630 690 626AM* 630AM*	Thick door* – (specify thickness if other than 1-3/4") SH* – Security head screws

*Indicates extra cost option.

**Decorative lever design sets are not available.

PART DESCRIPTION	PART NUMBER	PARTS PRICE
LEVER SETS		
40H Lever Set #3 design	40HLS -3	284.00
40H Lever Set #12 design	40HLS -12	352.00
40H Lever Set #14 design	40HLS-14	284.00
40H Lever Set #15 design	40HLS-15	284.00
40H Lever Set #16 design	40HLS-16	284.00
40H Lever Set #17 RH design	40HLS -17 RH	352.00
40H Lever Set #17 LH design	40HLS -17 LH	352.00
40H Decorative Lever Sets #50-91 designs	40HLS -XX*	495.00
40H Knob Set #4 design	40HLS-4	284.00

EXTRA COST OPTIONS*	OPTION CODE	ADD-ON
Thick Door	Specify Thickness	21.00
Security head screws	SH	21.00
UltraShield antimicrobial finish	626AM, 630AM	58.00

*Choose one decorative lever set design from #50-91



40H Replacement Spindles

Federal Spec. 86

ANSI Series 1000

How To Order

40HRS	2	
Series	Kit number	Options
40HRS – Replacement spindle kits	2 – 40H Standard spindle 4 – 40H Hook spindle	Thick door* – Specify thickness if other than 1 3/4"

*Indicates extra cost option.

PART DESCRIPTION	PART NUMBER	PARTS PRICE
REPLACEMENT SPINDLES		
40H Swivel spindle assembly	40HRS-2	34.00
40H Hook spindle assembly	40HRS-4	63.00

EXTRA COST OPTIONS*	OPTION CODE	ADD-ON
Thick door	Specify Thickness	21.00

40H Screw Kits

How To Order

40HSK	1	626	
Series	Kit number	Finishes	Options
40HSK – Screw kits	1 – H, R, S, J trim screw kit 2 – M, N trim screw kit 3 – Special purpose fasteners screw kit 4 – Surface-mounted trim screw kit 5 – Visual indicator screw kit	606 612 613 622 626	Thick door* – Specify thickness if other than 1 3/4" SH* – Security head screws

*Indicates extra cost option.

PART DESCRIPTION	PART NUMBER	PARTS PRICE
SCREW KITS		
H, R, S, J trim screw kit	40HSK-1	22.00
M, N trim screw kit	40HSK-2	22.00
Special purpose fasteners screw kit	40HSK-3	22.00
Surface-mounted trim screw kit	40HSK-4	22.00
Visual indicator screw kit	40HSK-5	22.00

EXTRA COST OPTIONS*	OPTION CODE	ADD-ON
Thick door	Specify Thickness	21.00
Security head screws	SH	21.00

40H Faceplate Kits

Federal Spec. 86

ANSI Series 1000

How To Order

40HFP	3	626	
Series	Kit number	Finishes	Options
40HFP – Faceplate kit	0 – for function: AB 1 – for functions: BW, TD, H, HJ 2 – for function: A 3 – for functions: AT, D, C, INL, NX, R, W 4 – for functions: N, LT 5 – for functions: AD, RD, YD, WD 6 – Blank with logo 7 – for functions: BA, S, TA 8 – for functions: B, G, IND, L, LB, T 9 – for functions: CHB, RHB 10 – Blank without logo	605 606 611 612 613 618 619 622 625 626 629 630 690	SH* – Security head screws

*Indicates extra cost option.

PART DESCRIPTION	PARTS PRICE
FACEPLATE KITS:	
All face plate kits	34.00

EXTRA COST OPTIONS*	OPTION CODE	ADD-ON
Security head screws	SH	21.00



40H Visual Indicator Thumb-Turn Kit

How To Order

40HVIT	J	626	1-3/4"
Series	Trim Style	Finishes	Door Thickness
40HVIT	H - 2 3/4" Dia. R - 2 3/4" Dia. S - 3 1/2" Dia. M - Forged J - Wrought	605 606 611 612 613 618 619 622 625 626 629 630 690 626AM * 630AM*	1-3/4" Thick door* - Specify thickness if other than 1-3/4"

*Indicates extra cost option.

Note: Thick Door option available for doors up to 5" thick

PART DESCRIPTION	PART NUMBER	PARTS PRICE
VISUAL INDICATOR THUMB-TURN		
Sectional Visual Thumb-Turn Indicator (H, R & S Trims)	40HVIT	112.00
Escutcheon Visual Thumb-Turn Indicator (J & M Trims)	40HVIT	195.00

EXTRA COST OPTIONS*	OPTION CODE	ADD-ON
Thick door	Specify Thickness	21.00
Ultrashield Antimicrobial Finish	626AM, 630AM	58.00

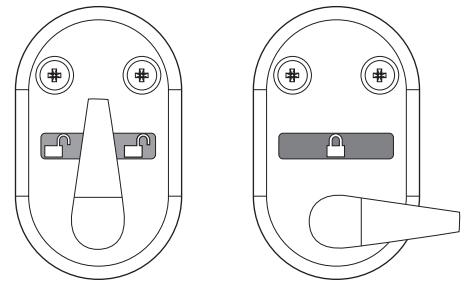

40H Indicator Laminate Kit

PART DESCRIPTION	PART NUMBER	PARTS PRICE
VISUAL INDICATOR LAMINATE		
Visual Indicator Laminate (for Thumb-Turn)	86329	18.00

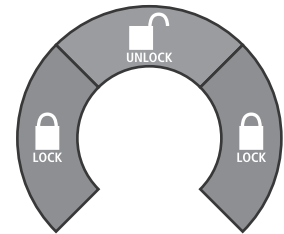



J Series Semi-Trailer Kingpin Locks

How To Order

2J	7	L	1	-	
Series	Core Housing	Latch Type	Head Type	Armored Front	Options
2J – Standard body	7 – 7-pin housing; accepts all BEST cores	L - Latch (Spring Return) D - Deadlocking Bolt	1 - Single Head Unit 2 - Double Head Unit	1 - Armored Front "- " - No Armored Front	TA* - Extended face without armored front

FUNCTION DESCRIPTION	FUNCTION CODE	COMPLETE WITH COMBINATED CORE			LESS CORE
		PATENTED*	PREMIUM**	STANDARD	
Single latch	L1	754.00	755.00	744.00	683.00
Double latch	L2	1107.00	1109.00	1087.00	965.00
Single deadbolt	D1	727.00	728.00	717.00	656.00
Double deadbolt	D2	1070.00	1072.00	1050.00	928.00

*If TA option is not included, only CORMAX M Series patented keying system can be used and pricing shown applies. If TA option is included, BEST Preferred keying system can be used and \$20.00 must be added to pricing shown. **Applicable only if TA option is included.

PART DESCRIPTION	CATALOG NUMBER	PRICE
Accessories:		
Warning flag assembly	2JOF1	70.00
Storage Racks:		
Three post mount	2JOR3	448.00
Three post—cad. plated	2JOR3C	561.00
Five post mount	2JOR5	751.00
Five post—cad. plated	2JOR5C	839.00

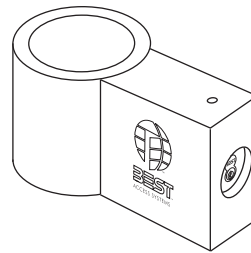

2J7L1

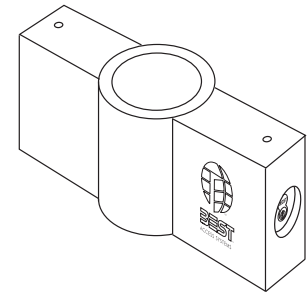

2J7L2

NOTE: Patented or Premium core is available in J Series with the TA option only.



6K Series Grade 2 Cylindrical Locks - Knobs

Federal Spec. 160

ANSI Series 4000

How To Order

6K	3	7	AB	4	C	STK	626	
Series	Backset	Core Housing	Function Code	Knob Style	Trim Style	Strike Package	Finish	Options
6K	2 – 2-3/8" 3 – 2-3/4" 4* – 3-3/4" 5* – 5"	0 – Keyless 7 – 7-pin housing; accepts all BEST cores	See below	4 – Round 6 – Tulip	C – 2-9/16" D* – 3-3/8" Rose	STK – Standard S3 – ANSI LS – Less strike	626 Satin* 606 612 613 Bright* 605 611 625	KNL* – Knurled knobs (keyed knob only) L8 – Drive-in latch NF – Narrow face latch (std with 62K) WF – Wide face latch (std with 63K)

FUNCTION DESCRIPTION	FUNCTION CODE	COMPLETE WITH COMBINATED CORE			LESS CORE
		PATENTED*	PREMIUM	STANDARD	
Single Keyed:					
Office	AB	288.00	289.00	278.00	217.00
Storeroom	D	288.00	289.00	278.00	217.00
Service station	E	288.00	289.00	278.00	217.00
Classroom	R	288.00	289.00	278.00	217.00
Keyless:					
Passage	N	N/A	N/A	N/A	131.00
Exit	Y	N/A	N/A	N/A	131.00
Privacy	L	N/A	N/A	N/A	176.00
Hospital privacy	LL	N/A	N/A	N/A	176.00
Patio	P	N/A	N/A	N/A	176.00
Single dummy trim	1DT	N/A	N/A	N/A	71.00
Double dummy trim	2DT	N/A	N/A	N/A	139.00

*Patented pricing shown is for CORMAX patented keying system. Add \$20.00 for BEST Preferred patented keying.

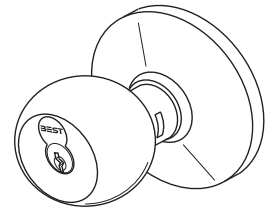

4D*

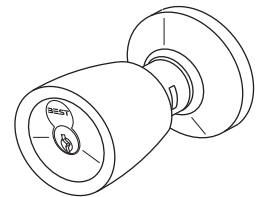

6C

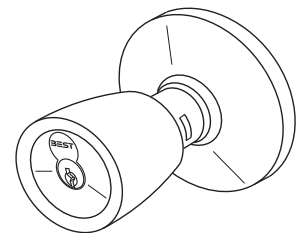

6D*

EXTRA COST OPTIONS*	OPTION CODE	ADD-ON
Satin finishes (per lock)	606, 612, 613, etc.	18.00
Bright finishes (per lock)	605, 611, 625, etc.	41.00
Special backset	64K / 65K	9.60
Knurled keyed knob	KNL	23.00
3-3/8" Rose	D	18.00

PART DESCRIPTION	PART NUMBER	PART PRICE
2-3/8" deadlocking latch	6KL2	38.00
2-3/4" deadlocking latch	6KL3	38.00
3-3/4" deadlocking latch	6KL4	45.00
5" deadlocking latch	6KL5	45.00
2-3/8" drive-in latch	6KL2-8	38.00
2-3/4" drive-in latch	6KL3-8	38.00
Standard strike package	7KCS2	6.80
ANSI strike package	7KCS3	20.00
Standard throw member	3125559	13.00
Standard strike box	B25640	4.10



7KC Series Grade 2 Cylindrical Locks - Levers

Federal Spec. 160

ANSI Series 4000

How To Order

7KC	3	7	AB	15	D	STK	626	
Series	Backset	Core Housing	Function Code	Lever Style	Trim Style	Strike Package	Finish	Options
7KC	2 – 2-3/8" 3 – 2-3/4" 4* – 3-3/4" 5* – 5"	0 – Keyless 6 – 6-pin non-IC cylinder 7 – 7-pin housing; accepts all BEST cores	See below	14 – Curved return 15 – Contour angle return 16 – Curved no return	D – 3-1/2"	STK – Standard S3 – ANSI	626 Satin* 606 612 613 Bright* 605 625	L8 – Drive-in latch (only available on 2-3/8" and 2-3/4" backset). 0B** – Zero bitted KA** – Keyed alike KD** – Keyed different OEM*** – Orig equipment mfg ATB – Alternate through-bolt NF – Narrow face latch

*Indicates extra cost option

**Six-pin cylinder in Schlage "C" keyway included with 0B, KA, & KD options. Must specify 6 for core housing.

***Cylinders not included with OEM option. Must specify "0" for core housing.

FUNCTION DESCRIPTION	FUNCTION CODE	COMPLETE WITH COMBINATED CORE			LESS CORE	NON-IC CYLINDER 0B, KA, KD
		PATENTED*	PREMIUM	STANDARD		
Single Keyed:						
Entrance	AB	341.00	342.00	331.00	270.00	313.00
Storeroom	D	341.00	342.00	331.00	270.00	313.00
Classroom	R	341.00	342.00	331.00	270.00	313.00
Keyless:						
Passage	N	N/A	N/A	N/A	197.00	N/A
Exit	Y	N/A	N/A	N/A	191.00	N/A
Privacy	L	N/A	N/A	N/A	217.00	N/A
Single dummy trim	1DT	N/A	N/A	N/A	88.00	N/A

*Patented pricing shown is for CORMAX patented keying system. Add \$20.00 for BEST Preferred patented keying.

EXTRA COST OPTIONS*	OPTION CODE	ADD-ON
Satin finishes (per lock)	612, 613, etc.	18.00
Bright finishes (per lock)	605, 625, etc.	41.00
Special backset	74KC / 75KC	9.60

PART DESCRIPTION	PART NUMBER	PART PRICE
2-3/8" deadlocking latch	7KCL2	38.00
2-3/4" deadlocking latch	7KCL3	38.00
3-3/4" deadlocking latch	6KL4	45.00
5" deadlocking latch	6KL5	45.00
Standard strike package	7KCS2	6.80
ANSI strike package	7KCS3	20.00
Standard strike box	B25640	4.10



8K Series Grade 1 Cylindrical Locks - Knobs

Federal Spec. 160

ANSI Series 4000

How To Order

8K	3	7	AB	4	D	STK	626	
Series	Backset	Core Housing	Function Code	Knob Style	Rose Style	Strike Package	Finish	Options
8K	3 – 2-3/4" 4* – 3-3/4" 5* – 5"	0 – Keyless 7 – 7-pin housing; accepts all BEST cores	See below	4 – Round 6 – Tulip	A – 3-3/8" concave C – 2-9/16" concave D – 3-3/8" convex E – 3-3/8" concave - thick door	STK – Standard S3 – ANSI S3 7/8* – 7/8" lip-to-center strike LS – Less strike S5 S6	626 690 626AM* Satin* 606 612 613 619 Bright* 605 611 625	3/4* – 3/4" throw BRK – Break-away (keyed only) FRL* – Full radius latch LL* – Lead lined (not available in double keyed functions) SH* – Security head screws SPN – Spin free (D & W only) TAC/B* – Tactile both knobs TAC/O* – Tactile outside knob TAC/I* – Tactile inside knob

*Indicates extra cost option; see below. Must specify keymark and number of keys.

FUNCTION DESCRIPTION	FUNCTION CODE	COMPLETE WITH COMBINATED CORE			LESS CORE
		PATENTED*	PREMIUM	STANDARD	
Single Keyed:					
Entrance	AB	662.00	663.00	652.00	591.00
Storeroom	D	662.00	663.00	652.00	591.00
Service station	E	662.00	663.00	652.00	591.00
Classroom	R	662.00	663.00	652.00	591.00
Dormitory	T	662.00	663.00	652.00	591.00
Special	Note**	662.00	663.00	652.00	591.00
Hotel (SPN-standard)	H, HJ	718.00	719.00	708.00	647.00
Double Keyed:					
Corridor	C	693.00	695.00	673.00	551.00
Storeroom	G	693.00	695.00	673.00	551.00
Communicating	S	693.00	695.00	673.00	551.00
Institutional	W	693.00	695.00	673.00	551.00
Special	DR, RD	693.00	695.00	673.00	551.00
Keyless:					
Passage	N, NX	N/A	N/A	N/A	446.00
Exit	Y	N/A	N/A	N/A	446.00
Privacy	L	N/A	N/A	N/A	514.00
Patio	P	N/A	N/A	N/A	514.00
Special	LL, M, Q, Z	N/A	N/A	N/A	514.00
Single dummy trim	1DT	N/A	N/A	N/A	191.00
Double dummy trim	2DT	N/A	N/A	N/A	382.00

*Patented pricing shown is for CORMAX patented keying system. Add \$20.00 for BEST Preferred patented keying.

**Single-keyed special functions include: A, B, DZ, EA, RH, RZ, XD, XR, YD, YR, YRH, YRM and YZ

ATTENTION: Locksets that secure both sides of the door (e.g., G, DR, M, RD, S, W, XD, YD & YR functions) are controlled by building codes and the Life Safety Code. Delay in unlocking for rapid emergency exit could be hazardous or even fatal.

8K Series Grade 1 Cylindrical Locks (continued)

EXTRA COST OPTIONS*	OPTION CODE	ADD-ON
Satin finishes (per lock)	606, 612, 613, etc.	18.00
Bright finishes (per lock)	605, 611, 625, etc.	41.00
UltraShield antimicrobial finish	626AM	57.00
3/4" throw latch	3/4	29.00
Special backsets	84K / 85K	20.00
Lead lined	LL	219.00
Security head screws	SH	21.00
Tactile knob both sides	TAC/B	80.00
Tactile knob outside	TAC/O	41.00
Tactile knob inside	TAC/I	41.00
7/8" Lip-to-center strike	S3 7/8	21.00
Full radius latch	FRL	20.00

PARTS DESCRIPTION	PART NUMBER	PART PRICE
2-3/4" deadlocking latch	8KL3	69.00
3-3/4" deadlocking latch	8KL4	87.00
5" deadlocking latch	8KL5	87.00
Standard strike package	8KS2	6.80
ANSI strike package	8KS3	20.00
Throw member 7-pin	B54200	1.50
Breakaway knob driver	B54856	7.50

NOTE 1: Other special single keyed functions include: A,B, EA, DZ, RZ, XD, XR, YD & YR. ATTENTION: Locksets that secure both sides of the door (e.g. G, DR, M, RD, S, W, XD, YD & YR functions) are controlled by building codes and the Life Safety Code. Delay in unlocking for rapid emergency exit could be hazardous or even fatal.

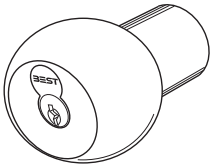

4 – Round

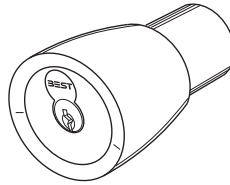

6 – Tulip

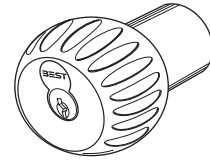

4 – TAC option
(Blind, safety, & handicapped application)

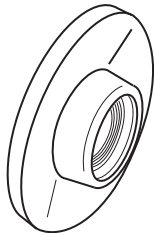

A and C Rose
(Concave)



D rose
(Convex)



9K Series Grade 1 Cylindrical Locks - Levers

Federal Spec. 160

ANSI Series 4000

How To Order

9K	3	7	AB	14	C	STK	626			
Series	Backset	Core Housing	Function Code	Lever Style	Rose Style	Strike Package	Finish	Options		
9K	3 – 2-3/4" 4* – 3-3/4" 5* – 5"	0 – Keyless functions / or / Non-IC competitive cylinder (less core)† 6 – 6-pin non-IC cylinder 7 – 7-pin housing; accepts all BEST cores	See below (Contact sales support for special functions and pricing.)	14 – Curved with return 15 – Contour angle with return 16 – Curved without return	C – 3" convex D – 3-1/2" convex K – 3" convex no ring L – 3-1/2" convex no ring	STK – Standard S3 – ANSI S3 7/8** STK 7/8*** LS – Less strike S3B* - ANSI (Strike w/ Plastic Box) S3B 7/8* - ANSI (Strike w/ Plastic Box)	626 690 622 626AM* Satin* 606 612 613 619 Bright* 605 611 625 618	3/4* – 3/4" throw latch AL/B* – Abrasive lever both sides AL/O* – Abrasive lever outside AL/I* – Abrasive lever inside TL/B* – Tactile lever both sides TL/O* – Tactile lever outside TL/I* – Tactile lever inside ATB – Alternate through-bolt mounting FRL* – Full radius latch LL* – Lead lined (N/A for double keyed functions) LM – Lost motion SH* – Security head screws Thin Door* – 1-3/8" OB* – non-IC zero bitted KA* – non-IC keyed alike KD* – non-IC keyed different COR* – non-IC Corbin-Russwin MED* – non-IC Medeco SAR* – non-IC Sargent SCH* – non-IC Schlage YAL* – non-IC Yale SCHRC – Schlage removable core WS – Windstorm Label (NOA Miami-Dade County)		
<p>*Indicates extra cost. Must specify keymark and number of keys. **S3 7/8 is the ANSI flat lip strike ***STK 7/8 is the standard flat lip strike</p>				<p>Choose only one option: OB, KA, KD-use with core housing option 6 COR, MED, SAR, SCH, YAL, SCHRC-use with core housing option 0</p>						

FUNCTION DESCRIPTION	FUNCTION CODE	COMPLETE WITH COMBINATED CORE			LESS CORE	NON-IC CYLINDER OB, KA, KD
		PATENTED*	PREMIUM	STANDARD		
Single Keyed:						
Entrance	AB	616.00	617.00	606.00	545.00	588.00
Storeroom	D	616.00	617.00	606.00	545.00	588.00
Service station	E	616.00	617.00	606.00	545.00	588.00
Classroom	R	616.00	617.00	606.00	545.00	588.00
Dormitory	T	616.00	617.00	606.00	545.00	588.00
Special**	Note	616.00	617.00	606.00	545.00	588.00
UA	UA	616.00	617.00	606.00	545.00	588.00
Hotel (SPN-standard)	H, HJ	670.00	671.00	660.00	599.00	642.00
Double Keyed:						
Corridor	C	740.00	742.00	720.00	598.00	684.00
Storeroom	G	740.00	742.00	720.00	598.00	684.00
Intruder***	IN	764.00	766.00	744.00	622.00	708.00
Communicating	S	764.00	766.00	744.00	622.00	708.00
Institutional	W	764.00	766.00	744.00	622.00	708.00
Special	DR, RD	764.00	766.00	744.00	622.00	708.00
Keyless:						
Passage	N, NX	N/A	N/A	N/A	380.00	N/A
Exit	Y	N/A	N/A	N/A	380.00	N/A
Privacy	L	N/A	N/A	N/A	438.00	N/A
Patio	P	N/A	N/A	N/A	438.00	N/A
Special	LL, M, Q, Z	N/A	N/A	N/A	438.00	N/A
Single dummy trim	1DT	N/A	N/A	N/A	160.00	N/A
Double dummy trim	2DT	N/A	N/A	N/A	316.00	N/A

*Patented pricing shown is for CORMAX patented keying system. Add \$20.00 for BEST Preferred patented keying.

**Single-keyed special functions include: A, B, DZ, EA, RH, RZ, XD, XR, YD, YR, YRH, YRM and YZ
*** IN Function includes interior indicator rose standard

9K Series Grade 1 Cylindrical Locks (continued)

EXTRA COST OPTIONS*	OPTION CODE	ADD-ON
Satin finishes (per lock)	606, 612, 613, etc.	18.00
Bright finishes (per lock)	605, 625, 629, etc.	41.00
UltraShield antimicrobial finish	626AM	57.00
Thin door 1-3/8"	1-3/8"	76.00
3/4" throw latch	3/4	29.00
Special backsets	94K / 95K	20.00
Lead lined	LL	219.00
Security head screws	SH	21.00
Abrasive lever both sides	AL/B	41.00
Abrasive lever outside	AL/O	21.00
Abrasive lever inside	AL/I	21.00
Tactile lever both sides	TL/B	80.00
Tactile lever outside	TL/O	41.00
Tactile lever inside	TL/I	41.00
7/8" Lip-to-center strike	S3 7/8 or STK 7/8	21.00
Strike with plastic box	S3B or S3B 7/8	2.10
Full radius latch	FRL	20.00

*Choose only one option: OB, KA, KD-use with core housing option 6. COR, MED, SAR, SCH, YAL, SCHRC-use with core housing option 0

*EXTRA COST OPTIONS	OPTION CODE	ADD-ON PRICE
Non-IC Corbin-Russwin (single keyed)	COR	6.30
Non-IC Corbin-Russwin (double keyed)	COR	14.00
Non-IC Medeco (single keyed)	MED	6.30
Non-IC Medeco (double keyed)	MED	14.00
Non-IC Sargent (single keyed)	SAR	6.30
Non-IC Sargent (double keyed)	SAR	14.00
Non-IC Schlage (single keyed)	SCH	6.30
Non-IC Schlage (double keyed)	SCH	14.00
Non-IC Yale (single keyed)	YAL	6.30
Non-IC Yale (double keyed)	YAL	14.00

NOTE: These options do not come with a cylinder. The lock is just prepped for cylinders of these other manufacturers and comes with a throw member for that manufacturer's cylinder.

PART DESCRIPTION	PART NUMBER	PART PRICE
2-3/4" deadlocking latch	8KL3	69.00
3-3/4" deadlocking latch	8KL4	87.00
5" deadlocking latch	8KL5	87.00
Standard strike package	8KS2	6.80
ANSI strike package	8KS3	20.00
Throw member 7-pin	B54200	1.50

NOTE 1: Other special single keyed functions include: A, B, EA, DZ, RZ, XD, XR, YD & YR. ATTENTION: Locksets that secure both sides of the door (e.g. G, DR, M, RD, S, W, XD, YD & YR 'functions) are controlled by building codes and the Life Safety Code. Delay in unlocking for rapid emergency exit could be hazardous or even fatal.

Adaptation Kit

9KA	SCHRCKT	14	626	Price
Family	Kit Type	Lever Style	Finish	
9KA - Adaptation Kit	SCHRCKT - Schlage RC Adaptation Kit	14 - Curved return 15 - Contour angle return 16 - Curved no return	606, 626, 612, 613	78.00

NOTE: Lever Style 16 is considered a special order item and may have extended lead times. Consult factory for lead times.

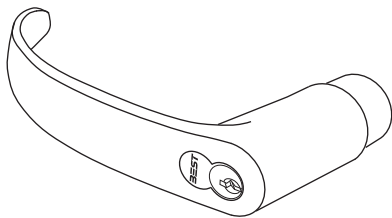

14 - Curved return

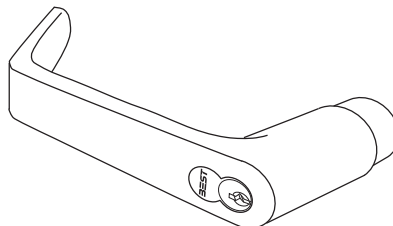

15 - Contour angle return

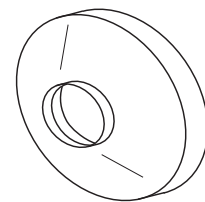

C and D Roses

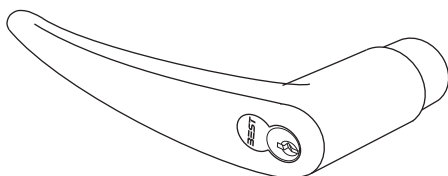

16 - Curved no return

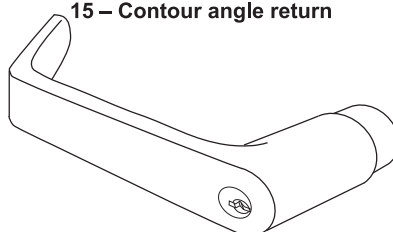

15 - Non IC contour angle return

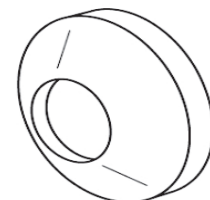

K and L roses



AK Series Knob Adaptations (formerly KA series)

How To Order

Series	Adaptation Kit Number	Finish
AK	Please contact BEST for the specific kit number to convert your heavy duty lockset. The name of the manufacturer and model number are required.	626

Must specify keymark and number of keys.

MANUFACTURER'S NAME	COMPLETE WITH COMBINATED CORE			LESS CORE PRICE
	PATENTED*	PATENTED*	PREMIUM	
Corbin	214.00	214.00	203.00	142.00
Sargent	235.00	235.00	224.00	163.00
Schlage	194.00	194.00	183.00	122.00
Russwin	214.00	214.00	203.00	142.00
Yale	235.00	235.00	224.00	163.00

INSTALLATION AT BEST FACTORY	59.00
-------------------------------------	-------

KIT COMPONENTS	KNOB ONLY LESS CORE	THROW MEMBER
Corbin	122.00	29.00
Sargent	138.00	21.00
Schlage	101.00	19.00
Russwin	118.00	29.00
Yale	138.00	24.00

*Patented pricing shown is for CORMAX patented keying system.
Add \$20.00 for BEST Preferred patented keying.

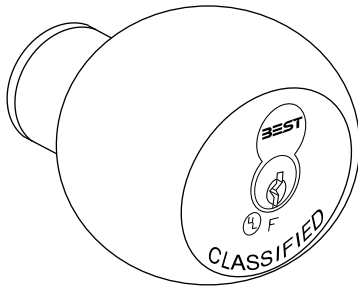

Schlage round

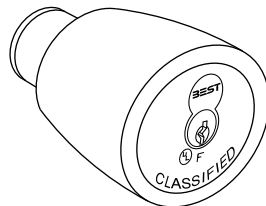

Schlage tulip

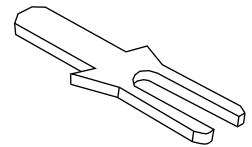

Schlage throw member



L Series Cabinet Locks

How To Order

5L	7	R	D	2	606	
Series	Core Housing	Mounting Type	Latch Type	Hand	Finish	Options
3L – Coin box	5 – 5-pin housing 6 – 6-pin housing 7 – 7-pin housing; accepts all BEST cores	R – Rim	D – Dead-locking	2 – Vertical	626 690 Satin*	1-1/8" to 2" – Special cylinder (specify length)
5L – Standard		M – Mortise R – Rim	D – Dead-locking L – Latchbolt	2 – Vertical 5 – Inverted	606 612 613 619 Bright* 605 611 625	

*Indicates extra cost option; see below. Must specify keymark and number of keys.

DESCRIPTION	SERIES	COMPLETE WITH COMBINED CORE			LESS CORE
		PATENTED*	PREMIUM	STANDARD	
CABINET LOCKS					
Cabinet—mortise & rim	3L	161.00	162.00	151.00	90.00
Cabinet—mortise & rim	5L	136.00	137.00	126.00	65.00

EXTRA COST OPTIONS*	OPTION CODE	ADD-ON
Square latch spl. cylinder	SL	17.00
Special cylinders-3L	1-1/2" to 2"	19.00
Special cylinders-5L	1-1/8" to 2"	19.00
Special finishes	See above	4.90

DESCRIPTION	CATALOG NO.	COMPLETE WITH COMBINED CORE			LESS CORE
		PATENTED*	PREMIUM	STANDARD	
8L SERIES MAIL BOX LOCK					
Standard mail box lock	8L7SPR-627	183.00	184.00	173.00	112.00

*Patented pricing shown is for CORMAX patented keying system. Add \$20.00 for BEST Preferred patented keying.

NOTE: You must specify the name of the manufacturer and the model number.

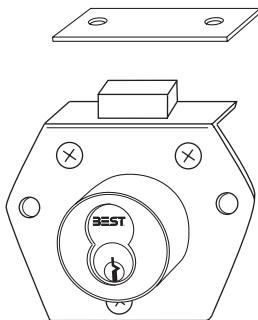

5L7RD2

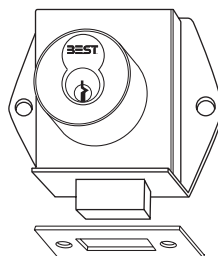

5L7MD

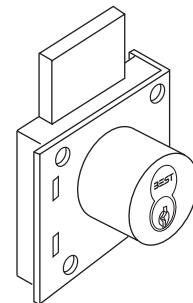

3L7RD2 - Vertical Only



P Series Push Locks

How To Order

2P	7	3	626
Series	Lock Body	Mounting slot	Finish
2P – File cabinet	7 – 7-pin body may be keyed 6-pin	3 – Vertical 4 – Horizontal	606 626

DESCRIPTION	CATALOG NO.	COMPLETE WITH COMBINATED CORE			LESS CORE
		PATENTED*	PREMIUM	STANDARD	
2P SERIES					
Vertical mounting slot	2P73	181.00	182.00	171.00	110.00
Horizontal mounting slot	2P74	181.00	182.00	171.00	110.00

*Patented pricing shown is for CORMAX patented keying system.
Add \$20.00 for BEST Preferred patented keying.

NOTE: You must specify the make, model and year of the filing cabinet for the 2P Series.

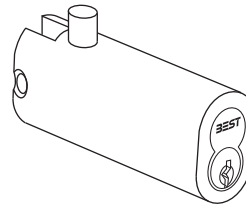

2P73

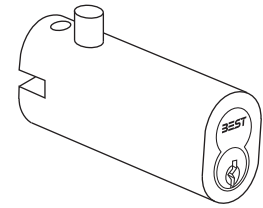

2P74



S Series Sliding Door Locks

How To Order

3S	7	5	627	
Series	Core housing	Function code	Finish	Options
2S – Sliding door push 3S – Sliding panel 4S – Sliding door cyl.	7 – 7-pin housing; accepts all BEST cores (4S requires 6C core)	See below	2S – 626, 605, 606, 622, 625 4S – 625, 605, 606, 626 3S – 627	3S – Strike straps: S1* – 1/4" thick S2* – Standard 1/4" S3 – 5/16" to 1/2" S4 – 1/2" to 11/16" S5 – 3/4" & thicker

*Included in the price of the housing.

FUNCTION DESCRIPTION	CATALOG NUMBER	COMPLETE WITH COMBINATED CORE			LESS CORE
		PATENTED*	PREMIUM	STANDARD	
2S SERIES					
Surface mount—1/2" bolt	3	240.00	241.00	230.00	169.00
Through bolt—1/2" bolt	3TBM	290.00	291.00	280.00	219.00
Through bolt—3/4" bolt	4TBM	290.00	291.00	280.00	219.00
Surface mount—bolt pin	5	290.00	291.00	280.00	219.00
3 S SERIES					
Straight housing	5	202.00	203.00	192.00	131.00
Captured panel housing	7	202.00	203.00	192.00	131.00
Housing with 1" extension	8	266.00	267.00	256.00	195.00
4 S SERIES					
Sliding glass door cylinder	3	141.00	142.00	131.00	70.00
Sliding wood door cylinder	4	153.00	154.00	143.00	82.00

* Patented pricing shown is for CORMAX patented keying system. Add\$20.00 for BEST Preferred patented keying.

** Lock requires 6C core (not available with Peaks or Preferred keying).

FUNCTION DESCRIPTION	PAR NUMBER	SEPARATE	WITH LOCK ADD-ON
3S STRIKE STRAPS			
4-1/4" long for 1/4" panel	3SS1	21.00	N/A
6-1/4" long for 1/4" panel	3SS2	25.00	N/A
STANDARD			
6-1/4" long for 5/16" to 1/2"	3SS3	37.00	14.00
6-1/4" long for 1/2" to 11/16"	3SS4	45.00	22.00
6-1/4" long for 3/4" or thicker	3SS5	33.00	6.10



SPSL – Stanley Patient Safety Lever

How To Order - Mortise Safety Levers

SPSL	ML	R		16F	630	RH
Series	Chassis	Function		Lever	Finish	Hand
SPSL – Stanley Patient Safety Lever	ML – Mortise	A – Office privacy D – Storeroom IND – Intruder deadbolt IND2 – Intruder storeroom dblt INL – Intruder latch LT – Bathroom privacy LTF – Bedroom privacy (Anti-Lockout) R – Classroom RF – Bedroom privacy T – Dormitory deadbolt W1 – Asylum lever/lever W2 – Asylum double cyl lever/lever	W3 – Asylum deadbolt lever/lever W4 – Asylum deadbolt double cyl lever/lever W10 – Asylum lever/blank W20 – Asylum double cyl lever/blank W30 – Asylum deadbolt lever/blank W40 – Asylum deadbolt double cyl lever/blank	16F – Anti-ligature lever	630 – Satin stainless steel	RH LH RHR LHR

PRODUCT DESCRIPTION	FUNCTION CODE	PRICE
Mortise Safety Lever		
Office privacy	A	1,572.00
Storeroom	D	1,449.00
Intruder deadbolt	IND	1,449.00
Intruder storeroom deadbolt	IND2	1,449.00
Intruder latch	INL	1,449.00
Bathroom privacy	LT	1,572.00
Passage	ON	1,326.00
Bedroom privacy (RF)	RF	1,572.00
Bedroom privacy Anti-Lockout (LTF)	LTF	1,572.00
Classroom	R	1,449.00
Dormitory deadbolt	T	1,449.00
Asylum lever/lever	W1	1,449.00
Asylum double cyl lever/lever	W2	1,449.00
Asylum deadbolt lever/lever	W3	1,449.00
Asylum deadbolt double cyl lever/lever	W4	1,449.00
Asylum lever/blank	W10	1,449.00
Asylum double cyl lever/blank	W20	1,449.00
Asylum deadbolt lever/blank	W30	1,449.00
Asylum deadbolt double cyl lever/blank	W40	1,449.00

How To Order - Cylindrical Safety Levers

SPSL	CL	ON	16F	630	RH
Series	Chassis	Function	Lever	Finish	Hand
SPSL – Stanley Patient Safety Lever	CL – Cylindrical 2 3/4" backset CL5 – Cylindrical 5" backset	ON – Cylindrical passage ONX – Cylindrical passage blank interior	16F – Anti-ligature lever	630 – Satin stainless steel	RH LH RHR LHR

PRODUCT DESCRIPTION	FUNCTION CODE	PRICE
Cylindrical Safety Lever		
Passage	ON	1,152.00
Passage blank interior	ONX	1,152.00
Dummy Trim		
Dummy Trim	DT	641.00

NOTE: 1) Security head screws come standard with SPSL series. 2) Standard offering is less cylinder and less core.



SPSL – Stanley Patient Safety Lever (continued)

PART DESCRIPTION	KIT NUMBER	LIST PRICE
Cylindrical Security head screw kit	SPSL-SH M1	17.00
Mortise Security head screw kit	SPSL-SH C1	17.00
Security head driver kit	SPSL-SH D1	17.00
Turnpiece Disable kit for Female Privacy Locks	SPSL-TD	108.00
Cylinder Protector for IC core cylind. SPSL (incl. 2 keys)	SPSL-CP-IC	761.00
Cylinder Protector for non-IC cylind. SPSL (incl. 2 keys)	SPSL-CP-NIC	761.00
Extra magnetic key for SPSL-CP	SPSL-CP-K	29.00

How To Order - Electrified Mortise Safety Levers

SP	SE		ML		R	N	L	630	RH	
Series	Electric Release Trim(s)		Chassis	Interior Trim Blank	Function Group			Finish	Hand	
	Designation	Exterior			Interior	RQE	DPS			LPS
SP- Stanley Patient Safety	SE	Electric Release Trim (Fail Secure)	Mechanical	ML- Mortise	'leave empty' - if interior trim required (standard) X** - No trim on the interior, just a blank plate (SPSE or SPSF only)	R* - Request to Exit N- Place-holder if RQE not selected	D* - Door Position N- Place-holder if DPS not selected	L* - Latch Position N- Place-holder if LPS not selected	630- Satin Stainless Steel	RH LH RHR LHR
	SF	Electric Release Trim (Fail Safe)	Mechanical							
	S3	Electric Release Trim (Fail Secure)	Electric Release Trim (Fail Secure)							
	S4	Electric Release Trim (Fail Safe)	Electric Release Trim (Fail Safe)							

*Indicates extra cost option.

**Option only available for SPSE and SPSF trims. Security hardware comes standard.

FUNCTION DESCRIPTION	FUNCTION CODE	PRICE
SPSE - Exterior Release Trim (Fail Secure)	NNN†	2,292.00
SPSF - Exterior Release Trim (Fail Safe)	NNN†	2,394.00
SPS3 - Exterior/Interior Release Trim (Fail Secure)	NNN†	2,350.00
SPS4 - Exterior/Interior Release Trim (Fail Safe)	NNN†	2,394.00

EXTRA COST OPTIONS*	OPTION CODE	ADD-ON
Function Code (RQE)	R	49.00
Function Code (DPS)	D	73.00
Function Code (LPS)	L	49.00

*Patented pricing shown is for CORMAX patented keying system. Add \$20 for Best Preferred patented keying. †Indicates extra cost options for RQE, DPS or LPS functions.



SSRL – STANLEY Seclusion Room/Time Out Room Locks

PRODUCT DESCRIPTION	PRODUCT NUMBER	PRICE
3-Point constant supervision	SSRLS-3	1,849.00
3-Point unsupervised	SSRLU-3	1,976.00
Alum. angled strike kit for 3 point outswing doors	SSRL-SK3	460.00
Single point constant supervision	SSRLS-1	1,091.00
Single point constant supervision, includes strike kit for outswing doors	SSRLS-1-SK1	1,139.00
Single point unsupervised	SSRLU-1	1,217.00
Single point unsupervised, includes strike kit for outswing doors	SSRLU-1-SK1	1,265.00
Strike kit for single point outswing doors	SSRL-SK1	49.00
3-Point constant supervision w/ digital counter	SSRLS-3-C	2,027.00
3-Point unsupervised w/ digital counter	SSRLU-3-C	2,153.00



SEDA – STANLEY Emergency Door Alarm

PRODUCT DESCRIPTION	PRODUCT NUMBER	PRICE
Sensor – 36" to 42" wide door	SEDA-DSA-P1	775.00
Sensor – 42" to 48" wide door	SEDA-DSA-P2	834.00
12 Door controller/power supply	SEDA-CPS-1A52-12	2,411.00
24 Door controller/power supply	SEDA-CPS-1A52-24	4,237.00
36 Door controller/power supply	SEDA-CPS-1A52-36	6,062.00
48 Door controller/power supply	SEDA-CPS-1A52-48	Consult factory
Second console output	SEDA-CPS-MOD-CONS-2	279.00
12 Door LED console	SEDA-DCRS-12	1,534.00
24 Door LED console	SEDA-DCRS-24	2,557.00
36 Door LED console	SEDA-DCRS-36	3,579.00
48 Door LED console	SEDA-DCRS-48	Consult factory
12 Door LED Wall Console	SEDA-WCRS-12	2,191.00
24 Door LED Wall Console	SEDA-WCRS-24	3,360.00
36 Door LED Wall Console	SEDA-WCRS-36	4,703.00
Wall mounted keyswitch	SEDA-KS101	279.00
Strobe light ceiling mount	SEDA-SL1	132.00
Strobe light ceiling mount w/ steel mounting plate	SEDA-SL2	161.00
Full surface angled alum. hinge modified for new or existing hinges	SEDA-ECHF5-MH-AL-4	907.00
Splice box for room w/ multiple doors	SEDA-SPLB-1	161.00



T Series Tubular Deadbolts

Federal Spec. 180, 181

Note: 8T=ANSI/BHMA Grade 1 • 7T=ANSI/BHMA Grade 2

How To Order

8T/7T	3	7	K	STK	606	
Series	Backset	Core Housing	Function Code	Strike	Finish	Options
8T	2 – 2-3/8"	7 – 7-pin housing; accepts all BEST cores	See below	STK – Std deadbolt S1 – ANSI deadbolt S4 – Lip deadbolt S5* – High security deadbolt (only available in 630 finish)	626	CS* – Concealed screws D5 – Drive-in bolt (8T only) LL* – Lead lined (8T only) NF – Narrow face 1": (8T only) SH* – Security head screws (8T only) Thick Door* – specify thickness (8T only) Thin Door* – specify thickness (8T only)
7T	3 – 2-3/4"				690 626AM* Satin* 606 612 613 619 Bright* 605 611 625 (8T only) 7T 626 612	

*Indicates extra cost option; see below.

DESCRIPTION	FUNCTION CODE	COMPLETE WITH COMBINED CORE			LESS CORE
		PATENTED*	PREMIUM	STANDARD	
8T DEADBOLTS					
Single-keyed—turnknob	K	255.00	256.00	245.00	184.00
Single-keyed—no turnknob	L	255.00	256.00	245.00	184.00
Non-keyed—turnknob	KL	N/A	N/A	N/A	152.00
Double-keyed—CS-standard	M	385.00	387.00	365.00	243.00
Single-keyed—classroom	S	255.00	256.00	245.00	184.00
7T DEADBOLTS					
Single-keyed—turnknob	K	186.00	187.00	176.00	115.00
Single-keyed—no turnknob	L	186.00	187.00	176.00	115.00
Double-keyed	M	304.00	306.00	284.00	162.00

* Patented pricing shown is for CORMAX patented keying system. Add \$20.00 for Best Preferred patented keying.

EXTRA COST OPTIONS*	OPTION CODE	ADD-ON
Satin finishes (per lock)	606, 612, 613, etc.	21.00
Bright finishes (per lock) (8T only)	605, 611, 625, etc.	21.00
UltraShield antimicrobial finish (8T only)	626AM, 630AM	32.00
Concealed screws (8T only)	CS	38.00
Lead lined (8T only)	LL	142.00
High security strikes	S5	29.00
Security head screws (8T only)	SH	21.00
Thick door (8T only)	Specify thickness	31.00
Thin door (8T; M function only)	Specify thickness	31.00

PART DESCRIPTION	PART NUMBER	PART PRICE
2-3/8" Deadbolt tube	8TD2B	42.00
2-3/4" Deadbolt tube	8TD3B	42.00
2-3/8" Drive-in bolt	8TD25	42.00
2-3/4" Drive-in bolt	8TD35	42.00
Std. deadbolt strike pkg.	8TSSTK	7.50
ANSI deadbolt strike pkg.	8TS1	23.00
Deadbolt lip strike pkg.	8TS4	7.50
High security strike pkg. / deadbolt	8TS5*	43.00

* 8TS5 only available in 630 finish

ATTENTION: Lockets that secure both sides of the door (e.g., L and M functions) are controlled by building codes and the Life Safety Code. Delay in unlocking for rapid emergency exit could be hazardous or even fatal.



9KX SHELTER Cylindrical Locks

Federal Spec. 160

ANSI Series 4000

How To Order

9KX	3	7	R	14	D	STK	626	Options	
Series	Backset	Core Housing	Function Code	Lever Style	Rose Style	Strike Package	Finish		
9KX	3 – 2-3/4" 4* – 3-3/4" 5* – 5"	0 – Keyless functions / or / Non-IC competitive cylinder (less core) † 6 – 6-pin non-IC cylinder 7 – 7-pin housing; accepts all BEST cores	R	14 – Curved with return 15 – Contour angle with return 16 – Curved without return	D – 3-1/2" convex	STK – Standard S3 – ANSI S3 7/8** STK 7/8*** LS – Less strike S3B* - ANSI (Strike w/ Plastic Box) S3B 7/8* - ANSI (Strike w/ Plastic Box)	626 690 622 626AM* Satin* 606 612 613 619 Bright* 605 611 625 618	3/4* – 3/4" throw latch AL/B* – Abrasive lever both sides AL/O* – Abrasive lever outside AL/I* – Abrasive lever inside TL/B* – Tactile lever both sides TL/O* – Tactile lever outside TL/I* – Tactile lever inside ATB – Alternate through-bolt mounting FRL* – Full radius latch LM – Lost motion Thin Door* – 1-3/8"	OB* – non-IC zero bitted KA* – non-IC keyed alike KD* – non-IC keyed different COR* – non-IC Corbin-Russwin MED* – non-IC Medeco SAR* – non-IC Sargent SCH* – non-IC Schlage YAL* – non-IC Yale SCHRC – Schlage removable core (14 & 16 lever only) WS – Windstorm Label (NOA Miami-Dade County)
*Indicates extra cost. Must specify keymark and number of keys. **S3 7/8 is the ANSI flat lip strike ***STK 7/8 is the standard flat lip strike						Choose only one option: OB, KA, KD-use with core housing option 6 COR, MED, SAR, SCH, YAL, SCHRC-use with core housing option 0			

FUNCTION DESCRIPTION	FUNCTION CODE	COMPLETE WITH COMBINATED CORE			LESS CORE	NON-IC CYLINDER OB, KA, KD
		PATENTED*	PREMIUM	STANDARD		
Electromechanical:						
9KX Standard Cylindrical Lock	R	771.00	772.00	761.00	700.00	743.00

*Patented pricing shown is for CORMAX patented keying system. Add \$20.00 for BEST Preferred patented keying.

EXTRA COST OPTIONS	OPTION CODE	ADD-ON
Satin finishes (per lock)*	606, 612, 613, etc.	18.00
Bright finishes (per lock)*	605, 625, 629, etc.	41.00
UltraShield antimicrobial finish*	626AM	57.00
Thin door 1-3/8"	1-3/8"	143.00
3/4" throw latch*	3/4	29.00
Special backsets*	94K / 95K	20.00
Abrasive lever both sides*	AL/B	41.00
Abrasive lever outside*	AL/O	21.00
Abrasive lever inside*	AL/I	21.00
Tactile lever both sides*	TL/B	80.00
Tactile lever outside*	TL/O	41.00
Tactile lever inside*	TL/I	41.00
7/8" Lip-to-center strike*	S3 7/8 or STK 7/8	21.00
Strike with plastic box*	S3B or S3B 7/8	2.10
Full radius latch*	FRL	20.00
Non-IC Corbin-Russwin (single keyed)**	COR	6.30
Non-IC Corbin-Russwin (double keyed)**	COR	14.00
Non-IC Medeco (single keyed)**	MED	6.30
Non-IC Medeco (double keyed)**	MED	14.00
Non-IC Sargent (single keyed)**	SAR	6.30
Non-IC Sargent (double keyed)**	SAR	14.00
Non-IC Schlage (single keyed)**	SCH	6.30
Non-IC Schlage (double keyed)**	SCH	14.00
Non-IC Yale (single keyed)**	YAL	6.30
Non-IC Yale (double keyed)**	YAL	14.00

PART DESCRIPTION	PART NUMBER	PART PRICE
2-3/4" deadlocking latch	8KL3	69.00
3-3/4" deadlocking latch	8KL4	87.00
5" deadlocking latch	8KL5	87.00
Standard strike package	8KS2	6.80
ANSI strike package	8KS3	20.00
Throw member 7-pin	B54200	1.50
SHELTER FOB	SHX-FOB	150.00
SHELTER Gateway	SHX-GTW	2950.00
SHELTER Repeater	SHX-RPT	750.00
SHELTER Repeater Pole Mount	SHX-PLE	150.00
SHELTER Gateway Power Pigtail Plug	SHX-PTL	25.00
SHELTER Omni-directional Gateway antenna with 20' plenum rated, low-loss, 20' cable	SHX-OMNI	1200.00

*Choose only one option: OB, KA, KD-use with core housing option 6. COR, MED, SAR, SCH, YAL, SCHRC-use with core housing option 0

** These options do not come with a cylinder. The lock is just prepped for cylinders of these other manufacturers and comes with a throw member for that manufacturer's cylinder.



W Series Electric Switch Locks

How To Order

1W	7	B1	626	SWR
Series	Core Housing	Function code	Finish	Optional Box**
1W	7 – 7-pin housing; accepts all BEST cores	See below	626 690 Satin* 606 612 613 619 Bright* 605 611 625	See below

*Indicates extra cost option; see below.

**Not all boxes are compatible with all switch locks. See the catalog for details.

FUNCTION DESCRIPTION	SWITCH TYPE	KEY POSITION 2***	KEY POSITION 3***	FUNCTION CODE	COMPLETE WITH COMBINED CORE			LESS CORE
					PATENTED*	PREMIUM	STANDARD	
Maintained Switch Locks								
Low voltage	SPDT	3 o'clock	N/A	A1	229.00	230.00	219.00	158.00
Single switch	SPDT	2 o'clock	N/A	B1	205.00	206.00	195.00	134.00
Single switch	SPDT	12 o'clock	N/A	B2	205.00	206.00	195.00	134.00
Single switch	SPST	5 o'clock	12 o'clock	C2**	275.00	276.00	265.00	204.00
Toggle switch	DPST	2 o'clock	N/A	D2	253.00	254.00	243.00	182.00
Toggle switch	TPDT	3 o'clock	9 o'clock	E2	256.00	257.00	246.00	185.00
Toggle switch	SPDT	2 o'clock	12 o'clock	L2	281.00	282.00	271.00	210.00
Dual switch	2 SPDT	3 o'clock	N/A	J1	271.00	272.00	261.00	200.00
Dual switch	2 SPDT	12 o'clock	N/A	J2	303.00	304.00	293.00	232.00
Momentary Switch Locks								
Single switch	SPDT	2 o'clock	12 o'clock	B3	229.00	230.00	219.00	158.00
Dual switch	2 SPDT	2 o'clock	12 o'clock	J3	271.00	272.00	261.00	200.00
Toggle switch	DPDT	2 o'clock	10 o'clock	K4	271.00	272.00	261.00	200.00
Dual switch	2 SPDT	2 o'clock	10 o'clock	P4	253.00	254.00	243.00	182.00
Quad switch	4 SPDT	2 o'clock	10 o'clock	R4	265.00	266.00	255.00	194.00

*Patented pricing shown is for CORMAX patented keying system. Add \$20.00 for BEST Preferred patented keying.

**Supplied with OC1 box only (included in price).

***Key position 1 for all switch locks is 12 o'clock except for the C2 function which is at 7 o'clock and the L2 function which is at 10 o'clock position.
For all switch locks, the key is removable in the 12 o'clock position only.

EXTRA COST OPTIONS*/OPTIONAL BOXES		
DESCRIPTION	CODE	PRICE
Satin finishes	606, 612, 613 etc.	3.90
Bright finishes	605, 611, 625 etc.	5.30
Interior box	INT	47.00
Standard octagon center mount	OC1	46.00
Deep octagon offset mount	OC2	77.00
Standard weather resistant box	SWR	251.00

PARTS		
FUNCTION CODE	REPLACEMENT SWITCH #	PRICE
A1	S4A	39.00
B1, B2, B3, J1, J2, J3, P4, & R4	S4B	15.00
C2	S4C	72.00
D2	S4D	25.00
E2	S4E	62.00
K4	S4K	62.00
L2	S4L	53.00



45HW Series Electromechanical Mortise Locks

How To Order

45HW	7	DEL	14	H	626	RH	
Series	Core Housing	Function Code	Lever Style	Trim Style	Finish	Door Hand	Options
45HW	0** – Less Core Housing 7 – 7-pin housing; accepts all BEST cores	Electrically-locked:*** DEL LEL NXEL TDEL TWEL WEL Electrically-un-locked:*** DEU LEU NXEU TDEU TWEU WEU	Levers: 3 – Solid tube/return 12* – Solid tube/no return 14 – Curved/return 15 – Contour/angle return 16 – Curved/no return 17* – Gull wing Knobs: 4 – Round Decorative* 50–91	H – 2-3/4" dia. R – 2-3/4" dia. S – 3-1/2" dia J* – Wrought M* – Forged N* – Forged (concealed cylinder; N trim invalid on non-keyed and double keyed functions)	626 630 690 626AM* 630AM* Satin* 606 612 613 619 622 Bright* 605 611 625 629	RH RHR LH LHR	C - Pre-Terminated Quick Connect Plug DS* – Door status monitor IDH* – Integrated Door Hardware LL* – Lead lined LS* – Latch status monitor RQE* – Request to exit Thick door* – Specify thickness 7/8"* – Flat lip strike VT* – Vandal Trim 12V – 12V Solenoid (24V is standard) TAC/I* – Tactile Lever Inside TAC/O* – Tactile lever Outside TAC/B* – Tactile Lever Both VIN* – Visual Indicator

* Indicates extra cost; see below.

** Indicates cost deduction; see below.

*** Fail safe functions (EL) and fail secure functions (EU) include a Temperature Control Module (TCM) with the price of the lock.

FUNCTION DESCRIPTION	FUNCTION CODE	COMPLETE WITH COMBINATED CORE			LESS CORE
		PATENTED*	PREMIUM	STANDARD	
45HW Electro-mechanical:					
45HW Single key, latch, fail secure	DEU	1388.00	1389.00	1378.00	1317.00
45HW Single key, latch, fail safe	DEL	1388.00	1389.00	1378.00	1317.00
45HW Double key, latch, fail secure	WEU	1520.00	1522.00	1500.00	1378.00
45HW Double key, latch, fail safe	WEL	1520.00	1522.00	1500.00	1378.00
45HW Keyless, latch, fail secure	NXEU	N/A	N/A	N/A	1256.00
45HW Keyless, latch, fail safe	NXEL	N/A	N/A	N/A	1256.00
45HW Single key, deadbolt, fail secure	TDEU	1415.00	1416.00	1405.00	1344.00
45HW Single key, deadbolt, fail safe	TDEL	1415.00	1416.00	1405.00	1344.00
45HW Double key, deadbolt, fail secure	TWEU	1547.00	1549.00	1527.00	1405.00
45HW Double key, deadbolt, fail safe	TWEL	1547.00	1549.00	1527.00	1405.00
45HW Keyless, deadbolt, fail secure	LEU	N/A	N/A	N/A	1283.00
45HW Keyless, deadbolt, fail safe	LEL	N/A	N/A	N/A	1283.00

*Patented pricing shown is for CORMAX patented keying system. Add \$20.00 for BEST Preferred patented keying.

EXTRA COST OPTIONS*	OPTION CODE	ADD-ON
Satin finishes (per lock)	606, 612, 613, 619 etc.	56.00
Bright finishes (per lock)	605, 611, 625, etc.	110.00
UltraShield antimicrobial finish	626AM, 630AM	122.00
Wrought trim	J	11.00
Thick door	Specify thickness	81.00
Lead lined	LL	224.00
Forged trim	M, N	90.00
7/8" Lip-to-center strike	7/8 LTC	21.00
12, 17 Lever Design	12, 17	63.00
Vandal trim - 630 finish***	VT	143.00
Vandal trim - other finishes***	VT	109.00
Visual Indicator	VIN	42.00

Security Head Screws provided standard on 47HW.

**Not available on #17 levers.

***Available only with #14 and #15 levers. Only #14 lever complies with California State Fire Marshall Code.

EXTRA COST OPTIONS*	OPTION CODE	ADD-ON
Request to exit	RQE	41.00
Integrated door hardware	IDH	118.00
Latch status monitor	LS	86.00
Door status monitor	DS	118.00
Tactile both levers/knobs**	TAC/B	115.00
Tactile outside lever/knob**	TAC/O	58.00
Tactile inside lever/knob**	TAC/I	58.00
Decorative Lever Design	50 to 91	202.00

**COST DEDUCTIONS	OPTION CODE	DEDUCT
Less cylinder option (Deduct from complete price)	0	61.00



47HW Series High Security Electromechanical Mortise Locks

How To Order

47HW	7	DEL	14	H	626	RH	
Series	Core Housing	Function Code	Lever Style	Trim Style	Finish	Door Hand	Options
47HW	0** – Less Core Housing 7 – 7-pin housing; accepts all BEST cores	Electrically-locked:*** DEL TDEL TWEL WEL Electrically-un-locked:*** DEU TDEU TWEU WEU	Levers: 3 – Solid tube/return 12* – Solid tube/no return 14 – Curved/return 15 – Contour/angle return 16 – Curved/no return 17* – Gull wing Knobs: 4 – Round Decorative* 50-91	M – forged H**** – 2-3/4" dia. R**** – 2-3/4" dia. S**** – 3-1/2" dia	626 630 690 626AM* 630AM* Satin* 606 612 613 619 622 Bright* 605 611 625 629	RH RHR LH LHR	C - Pre-Terminated Quick Connect Plug DS* – Door status monitor IDH* – Integrated Door Hardware LS* – Latch status monitor RQE* – Request to exit Thick door* – (Specify thickness) 7/8"* – Flat lip strike VT* – Vandal Trim 12V – 12V Solenoid (24V is standard) K – Non-UL Cylinder TAC/I* – Tactile Lever Inside TAC/O* – Tactile lever Outside TAC/B* – Tactile Lever Both

* Indicates extra cost; see below.

** Indicates cost deduction; see below.

*** Fail safe functions (EL) and fail secure functions (EU) include a Temperature Control Module (TCM) with the price of the lock.

****To maintain the UL437 standard for high security locks, order only M trim. Using H, R or S trim does not meet the UL437 standard.

FUNCTION DESCRIPTION	FUNCTION CODE	COMPLETE WITH COMBINATED CORE			LESS CORE
		PATENTED*	PREMIUM	STANDARD	
47HW Electro-mechanical:					
47HW Single key, latch, fail secure	DEU	1412.00	N/A	1407.00	Note: 47HW Series must be keyed at the factory unless the K Option is ordered
47HW Single key, latch, fail safe	DEL	1412.00	N/A	1407.00	
47HW Double key, latch, fail secure	WEU	1612.00	N/A	1602.00	
47HW Double key, latch, fail safe	WEL	1612.00	N/A	1602.00	
47HW Single key, deadbolt, fail secure	TDEU	1439.00	N/A	1434.00	
47HW Single key, deadbolt, fail safe	TDEL	1439.00	N/A	1434.00	
47HW Double key, deadbolt, fail secure	TWEU	1629.00	N/A	1619.00	
47HW Double key, deadbolt, fail safe	TWEL	1629.00	N/A	1619.00	

*Pricing reflects the 5C high security core for standard and the 5CM high security CORMAX core for patented.

EXTRA COST OPTIONS*		ADD-ON
Thick door	Specify thickness	81.00
7/8" Lip-to-center strike	7/8 LTC	21.00
12, 17 Lever Design	12, 17	63.00
UltraShield antimicrobial finish	626AM, 630AM	58.00
Decorative Lever Design	50-91	202.00
Vandal trim - 630 finish***	VT	143.00
Vandal trim - other finishes***	VT	109.00
Request to exit	RQE	41.00
Integrated door hardware	IDH	118.00
Latch status monitor	LS	86.00
Door status monitor	DS	118.00
Satin finish (per lock)	606, 612, 613, 619, etc.	56.00
Bright finish (per lock)	605, 611, 625, etc.	110.00

**Not available on #17 levers.

***Available only with #14 and #15 levers.

Only #14 lever complies with California State Fire Marshall Code.

EXTRA COST OPTIONS*	OPTION CODE	ADD-ON
Tactile both levers/knobs**	TAC/B	115.00
Tactile outside lever/knob**	TAC/O	58.00
Tactile inside lever/knob**	TAC/I	58.00

** COST DEDUCTIONS	OPTION CODE	DEDUCT
Less cylinder option (Deduct from complete price)	0	61.00

Security Head Screws provided standard on 47HW

ATTENTION: Locksets that secure both sides of the door (e.g., WEL and WEU) are controlled by building codes and the Life Safety Code. Delay in unlocking for rapid emergency exit could be hazardous or even fatal.



8KW/9KW Series Electromechanical Cylindrical Locks

How To Order

8KW	3	7	DEL	4	C	STK	626	
Series	Backset	Core Housing	Function Code	Knob Style	Rose Style	Strike Package	Finish	Options
8KW	3 – 2-3/4" 4* – 3-3/4" 5* – 5"	7 – 7-pin housing; accepts all BEST cores	DEL** – Electrically locked DEU** – Electrically unlocked	4 – Round 6 – Tulip	C – 3" convex D – 3-1/2" convex K – 3" convex L – 3-1/2" convex	STK – Standard S3 – ANSI	626 690 626AM* Satin* 606 612 613 619 622 Bright* 605 611 625	BRK – Break-away (keyed only) C – Pre-Terminated Quick Connect Plug LL* – Lead lined SH* – Security head screws 3/4* – 3/4" throw RQE* – Request to Exit Thin Door* – 1-3/8" TAC/I* – Tactile Lever Inside TAC/O* – Tactile lever Outside TAC/B* – Tactile Lever Both 12V - Specify 12V System: Standard voltage is 24V

* Indicates extra cost; see below.

** Fail safe functions (EL) and fail secure functions (EU) include a Temperature Control Module (TCM) with the price of the lock.

9KW	3	7	DEL	15	C	S3	626	
Series	Backset	Core Housing	Function Code	Lever Style	Rose Style	Strike Package	Finish	Options
9KW	3 – 2-3/4" 4* – 3-3/4" 5* – 5"	0*** – Non-IC Prep 6** – 6 pin Non-IC Cylinder 7 – 7-pin Housing; accepts all BEST cores	DEL – Electrically locked**** DEU – Electrically unlocked****	14 – Curved with return 15 – Contour with angle return 16 – Curved with no return	C – 3" convex D – 3-1/3" convex K – 3" convex no ring L – 3-1/2" convex no ring	STK – Standard S3 – ANSI S3 7/8* – 7/8 Lip to Center strike LS – Less Strike S3B* - ANSI (Stike w/ Plastic Box) S3B 7/8* - ANSI (Stike w/ Plastic Box)	626 690 626AM* Satin* 606 612 613 619 622 Bright* 605 611 625	3/4* – 3/4" throw latch ATB – Alternate through-bolt mounting C – Pre-Terminated Quick Connect Plug LL* – Lead lined SH* – Security head screws LM – Lost motion RQE* – Request to Exit Thin Door* – 1-3/8" AL/O* – Abrasive Lever Outside AL/I* – Abrasive Lever Inside AL/B* – Abrasive Lever Both TL/O* – Tactile Lever Outside TL/I* – Tactile Lever Inside TL/B* – Tactile Lever Both OB** – Non-IC zero-bitted KA** – Non-IC keyed alike KD** – Non-IC keyed different COR*** – Non-IC Corbin-Russwin MED*** – Non-IC Medeco SAR*** – Non-IC Sargent SCH*** – Non-IC Schlage YAL*** – Non-IC Yale SCHRC*** – Schlage RC (14 & 15 lever only) 12V - Specify 12V System: Standard voltage is 24V

* Indicates extra cost option.

** Six-pin cylinder in Schlage "C" keyway included with OB, KA, and KD options. Must specify "6" for core housing.

*** Cylinder not included with COR, MED, SAR, SCH, YAL, or SCHRC options. Must specify "0" for core housing.

**** Fail safe functions (EL) and fail secure functions (EU) include a Temperature Control Module (TCM) with the price of the lock.



8KW/9KW Series Electromechanical Cylindrical Locks (continued)

FUNCTION DESCRIPTION	FUNCTION CODE	COMPLETE WITH COMBINATED CORE			LESS CORE	NON-IC CYLINDER 0B, KA, KD
		PATENTED*	PREMIUM	STANDARD		
Electromechanical:						
8KW Elect. locked / unlocked	DEL, DEU	1028.00	1029.00	1018.00	957.00	N/A
9KW Elect. locked / unlocked	DEL, DEU	918.00	919.00	908.00	847.00	890.00

*Patented pricing shown is for CORMAX patented keying system. Add \$20.00 for BEST Preferred patented keying.

EXTRA COST OPTIONS*	OPTION CODE	ADD-ON
Satin finishes (per lock)	606, 612, 613, etc.	18.00
Bright finishes (per lock)	605, 625, 629, etc.	41.00
UltraShield antimicrobial finish	626AM	57.00
Thin door 1-3/8"	1-3/8"	76.00
3/4" throw latch	3/4	29.00
Special backsets	84K / 85K / 94K / 95K	20.00
Lead lined	LL	219.00
Security head screws	SH	21.00
Tactile knob both sides	TAC/B	80.00
Tactile knob outside	TAC/O	41.00
Tactile knob inside	TAC/I	41.00
Abrasive lever both sides	AL/B	41.00
Abrasive lever outside	AL/O	21.00
Abrasive lever inside	AL/I	21.00
Tactile lever both sides	TL/B	80.00
Tactile lever outside	TL/O	41.00
Tactile lever inside	TL/I	41.00
7/8" Lip-to-center strike	S3 7/8	21.00
Strike with plastic box	S3B or S3B 7/8	2.10
Request to exit	RQE	159.00

PART DESCRIPTION	PART NUMBER	PRICE
2-3/4" deadlocking latch	8KL3	69.00
3-3/4" deadlocking latch	8KL4	87.00
5" deadlocking latch	8KL5	87.00
Standard strike package	8KS2	6.80
ANSI strike package	8KS3	20.00
Throw member 6-pin / 7-pin	71217417 / B54200	1.50
Breakaway knob driver	B54856	7.50



Electromechanical Lock Accessories

DESCRIPTION	CATALOG NO.	PRICE
Transformer	8W599	141.00
AC to DC converter	8WCON	54.00
Narrow plate (push button)	8WBU-1-N	96.00
Standard plate (push button)	8WBU-1-A	96.00
Universal temperature control module	B87034	154.00



Electric Strike 4

DESCRIPTION	FAMILY / SERIES / MODEL / FACE PLATE	PRICE
ES4 Electric Strike with 4 7/8 faceplate - square corner	ES4 S A-S	189.00
ES4 Electric Strike with 4 7/8 faceplate - round corner	ES4 S A-R	194.00
ES4 Electric Strike with 6 7/8 faceplate	ES4 S B	203.00
ES4 Electric Strike with 7 15/16 faceplate	ES4 S C	208.00

DESCRIPTION	SERIES ADDER	PRICE
Standard - no monitoring	S	N/C
Keeper open / closed status	K	43.00

DESCRIPTION	FINISH ADDER	PRICE
Satin Brass	606	33.00
Oil Rubbed Bronze	613	33.00
Satin Aluminum	628	N/C
Satin Stainless Steel	630	N/C

How To Order

Series	Model	Faceplate	Finish
ES4	S- standard	A-S- 4 7/8 square	606
	K- keeper open/ closed status	A-R- 4 7/8 round	613
		B-6 7/8*	628
		C-7 15/16*	630

*Note - 6 7/8 & 7
15/16 only available
in 628 finish



Electric Strike 5

DESCRIPTION	FAMILY / SERIES / MODEL / FACE PLATE	PRICE
ES5 electric strike for cylindrical locks up to 5/8 latch	ES5 A	493.00
ES5 electric strike for mortise locksets & exit mortise devices with or without a deadlatch located below the latch-bolt. Accurate, Arrow, BEST, Corbin Russwin, Dorma, Falcon, Marks, Sargent, Yale	ES5 B	513.00
ES5 electric strike for mortise locksets & exit mortise devices with or without a deadlatch located above the latch-bolt. SDC, Schlage, Baldwin, Hager	ES5 C	513.00
ES5 electric strike for mortise locks with a deadbolt and deadlatch located below the latchbolt. Accurate, Arrow, BEST, Corbin Russwin, Dorma, Falcon, Marks, Sargent, Yale.	ES5 D	532.00
ES electric strike for mortise locks with deadbolt and no deadlatch feature. Baldwin	ES5 E	532.00
ES5 electric strike for mortise locks with a deadbolt and deadlatch located above the latchbolt. SDC, Schlage, Hager.	ES5 F	532.00

DESCRIPTION	MONITORING OPTIONS	PRICE
Latch bolt monitoring	LBM	76.00
Latch bolt and deadlock monitoring	LBM / LCM	144.00
Deadbolt monitoring - Right hand - (Available with LBM and LCM. For D, E and models only)	DBM - RH	76.00
Deadbolt monitoring - Left hand - (Available with LBM and LCM. For D, E and models only)	DBM - LH	76.00

DESCRIPTION	FINISH OPTIONS	PRICE
Satin Brass	606	54.00
Satin Bronze	612	54.00
Oil Rubbed Bronze	613	54.00
Bright Chrome	625	54.00
Satin Stainless Steel	630	N/C

How To Order

Series	Model	Monitoring Options	Handing	Finish
ES5	A- Compatible locks with all cylindrical locksets with up to 5/8" latch.	S-Standard*	RH	606
	B- Mortise locksets and exit mortise devices with or without a deadlatch located below the latchbolt. Accurate, Arrow, BEST, Corbin Russwin, Dorma, Falcon, Marks, Sargent, Yale.	LBM- Latch Monitoring	LH	612
	C- Mortise locksets and mortise exit devices with or without a deadlatch located above the latchbolt. SDC, Schlage, Baldwin, Hager.	LBM/LCM-Latchbolt and Deadlock Monitoring		613
	D- Mortise locksets with a deadbolt and deadlatch located below the latchbolt. Accurate, Arrow, BEST, Corbin Russwin, Dorma, Falcon, Marks, Sargent, Yale.	DBM- Deadbolt Monitoring**		625
	E- Mortise lockset with deadbolt and no deadlatch feature. Baldwin.			630
	F- Mortise locksets with a deadbolt and a deadlatch located above the latchbolt. SDC, Schlage, Hager.			

*Patented pricing shown is for CORMAX patented keying system. Add \$20.00 for BEST Preferred patented keying.



Electronic Lock Software & Accessories

For Wi-Q Technology Wireless software, accessories and locks, see pages 89-94

DESCRIPTION	PART NUMBER	PRICE
Readers		
Magnetic card access reader – 12VDC, track 2, weatherized (no keypad), black (MR-5)	360120WBK	473.00
Dual validation (magnetic stripe & keypad) reader – 12VDC, track 2, weatherized, black case (MR-20), with tamper contact	310120WBKOT	907.00
HID Proximity reader – MiniProx – Gray with pigtail leads (5–16 VDC)	5365EGP00	483.00
Indala proximity reader – slim, graphite, 5 inch length	FP4515A	501.00
Mullion mount multi-frequency reader	XF1100D	426.00

B.A.S.I.S. G	B.A.S.I.S. V	Keypad EZ	IDH MAX
G	BV	Z	M

Cards	PART NUMBER	PRICE
MAGNETIC STRIPE CARDS Non-Encoded:		
PVC (box of 500)	VPA-PVC	1995.00
PROXIMITY CARDS (HID & Indala Branded):		
HID® Clam shell (box of 100) HID® branded	1326LSSMV	600.00
Indala® Clam shell (box of 100) Indala® branded	FPCRDSSSMW0000	644.00

X	X		X
	X		X
	X		X



Electronic Lock Software & Accessories (continued)

DESCRIPTION	PART NUMBER
Electronic Lock Accessories (Continued)	
REPLACEMENT PARTS:	
Shrink wrap battery pack & foam*	VPD-BATT
Replacement battery pack	VPD-BB
4 Cell Battery holder for new style 2 piece I/S escutcheon offline products	C83511
8 Cell Battery holder for new style 2 piece I/S escutcheon offline products	C83522
Extended life battery door cover	B62129
SERVICE EQUIPMENT:	
Offline lock programming cable	BASDCAB
Magnetic Card Encoder	MSR20633BA
Transport Programming Device	SES-NetBook
Transport Memory Drive	SES-MEM
Transport USB to Serial Adapter	SES-USB
Transport connector/adaptor (no cable, used to connect SES-USB to BASDCAB)	SES-DB9CON
Transport cable adapter (6' Cable adapter)	SES-DB9CAB
Power supply – 12 or 24 VDC, 2.5A output, 120 VAC input, UL	AL300ULX
Backup battery for power supply, 12 VDC, 12 AH	NP12A12V
Standard driver bit	VPD-T15
McGard driver bit	VPD-HS-DRVR
McGard battery door screw (specify finish)	VPD-HS-SCRW
Cleaning cards (box of 50)	VPDCLN

B.A.S.I.S.G	B.A.S.I.S.V	Keypad EZ	IDH MAX
G	BV	Z	M
X	X	X	
X	X	X	
X	X	X	
X	X	X	
X	X		
X	X		X
X	X		
X	X		
X	X		
X	X		
X	X		
X	X	X	X
X	X	X	X
X	X	X	X
X	X		X

*VPD-BATT used with legacy V Series locks only



45HZ Keypad EZ Mortise Locks

How To Order

45HZ	7	TV	15	KP	626	RH	
Series	Core Housing	Function Code	Lever Style	Trim Style	Finish	Door Hand	Options
45HZ	0** – Less Core Housing 7 – 7-pin housing; accepts all BEST cores	DV – Latch with key TV – Deadbolt with key NV – Latch without key LV – Deadbolt without key	Levers: 3 – Solid tube/return 12* – Solid tube/no return 14 – Curved/return 15 – Contour/angle return 16 – Curved/no return 17* – Gull wing 4 – Round Knob Decorative* 50-91	KP – Keypad	626 690 626AM* – Antimicrobial Satin* 606 612 613 619 622 Bright* 605 611 618 625	RH RHRB LH LHRB	8CE* – 8-cell battery holder assy with batteries 4SW – 4-cell shrink wrap battery P2*** – Phillips head screws Thick Door* – Specify thickness 7/8** – Flat lip strike TAC/I* – Tactile Lever Inside TAC/O* – Tactile lever Outside TAC/B* – Tactile Lever Both WS – Windstorm Label (NOA Miami-Dade County)

* Indicates extra cost; see below.

** Indicates cost deduction.

*** T15 Torx security screws are supplied standard.

DESCRIPTION	FUNCTION CODE	COMPLETE WITH COMBINATED CORE			LESS CORE
		PATENTED*	PREMIUM	STANDARD	
KEYPAD EZ MORTISE LOCKS:					
45HZ - Single Keyed Latch	DV	1228.00	1229.00	1218.00	1157.00
45HZ - Single Keyed Deadbolt	TV	1253.00	1254.00	1243.00	1182.00
45HZ - Non-keyed Latch	NV	N/A	N/A	N/A	1096.00
45HZ - Non-keyed Deadbolt	LV	N/A	N/A	N/A	1121.00

*Patented pricing shown is for CORMAX patented keying system. Add \$20.00 for BEST Preferred patented keying.

EXTRA COST OPTIONS*	OPTION CODE	ADD-ON
Satin finishes (per lock)	606, 612, 613, 619 etc.	56.00
Bright finishes (per lock)	605, 611, 625, etc.	110.00
UltraShield antimicrobial finish	626AM	122.00
Thick door	Specify thickness	81.00
Tactile both levers/knobs**	TAC/B	115.00
Tactile outside lever/knob**	TAC/O	58.00
Tactile inside lever/knob**	TAC/I	58.00
7/8" Lip-to-center strike	7/8 LTC	21.00
12, 17 Lever Design	12, 17	63.00
Decorative Lever Design	50-91	202.00
Extended Life Battery	8CE	65.00

** Not available on #17 levers.

**COST DEDUCTIONS	OPTION CODE	DEDUCT
Less cylinder option (Deduct from complete price)	0	61.00



9KZ Keypad EZ Cylindrical Locks

How To Order

9KZ	3	7	DV	15	KP	STK	626	
Series	Backset	Core Housing	Function Code	Lever Style	Trim Style	Strike Package	Finish	Options
9KZ	3 – 2-3/4" 4* – 3-3/4" 5* – 5"	0*** – Non-IC Prep 6** – 6 pin non-IC cylinder 7 – 7-pin housing; accepts all BEST cores	DV - With Key	14 – Curved with return 15 – Contour angle return 16 – Curved with no return 4 – Round Knob	KP – Keypad	STK - Standard S3 - ANSI S3 - 7/8" Lip to Center Strike S3B* - ANSI (Strike w/ Plastic Box) S3B 7/8* - ANSI (Strike w/ Plastic Box)	626 690 626AM* Satin* 606 612 613 619 622 Bright* 605 611 618 625	8CE* – 8 cell battery holder assy with batteries 4SW – 4 cell shrink wrap battery P2**** – Phillips head screws LM – Lost motion 3/4* – 3/4" throw latch 0B* – non-IC zero-bitted KA* – non-IC keyed alike KD* – non-IC keyed different COR*** – Non IC Corbin-Russwin MED*** – Non IC Medeco SAR*** – Non IC Sargent SCH*** – Non IC Schlage YAL*** – Non IC Yale SCHRC*** – Schlage RC (14 & 15 lever only) AL/O* – Abrasive Lever Outside AL/I* – Abrasive Lever Inside AL/B* – Abrasive Lever Both TL/O* – Tactile Lever Outside TL/I* – Tactile Lever Inside TL/B* – Tactile Lever Both WS – Windstorm Label (NOA Miami-Dade County)

* Indicates extra cost option.

** Six-pin cylinder in Schlage "C" keyway included with 0B, KA, and KD options. Must specify "6" for core housing.

*** Cylinder not included with COR, MED, SAR, SCH, YAL, or SCHRC options. Must specify "0" for core housing.

**** T15 Torx security screws are supplied standard.

FUNCTION DESCRIPTION	FUNCTION CODE	COMPLETE WITH COMBINATED CORE			LESS CORE	NON-IC CYLINDER 0B, KA, KD
		PATENTED*	PREMIUM	STANDARD		
KEYPAD EZ CYLINDRICAL LOCK:						
9KZ - Single keyed lock	DV	1053.00	1054.00	1043.00	982.00	1025.00

*Patented pricing shown is for CORMAX patented keying system. Add \$20.00 for BEST Preferred patented keying.

EXTRA COST OPTIONS*	OPTION CODE	ADD-ON
Satin finishes (per lock)	606, 612, 613, etc.	56.00
Bright finishes (per lock)	605, 625, 629, etc.	110.00
UltraShield antimicrobial finish	626AM	122.00
3/4" throw latch	3/4	29.00
Special backsets	94KZ / 95KZ	20.00
Abrasive lever both sides	AL/B	41.00
Abrasive lever outside	AL/O	21.00
Abrasive lever inside	AL/I	21.00
Tactile lever both sides	TL/B	80.00
Tactile lever outside	TL/O	41.00
Tactile lever inside	TL/I	41.00
7/8" Lip-to-center strike	S3 7/8	21.00
Strike with plastic box	S3B or S3B 7/8	2.10
Extended Life Battery	8CE	65.00

PART DESCRIPTION	PART NUMBER	PRICE
2-3/4" deadlocking latch	8KL3	69.00
3-3/4" deadlocking latch	8KL4	87.00
5" deadlocking latch	8KL5	87.00
Standard strike package	8KS2	6.80
ANSI strike package	8KS3	20.00
Throw member 6-pin / 7-pin	71217417 / B54200	1.50



EXZ Keypad EZ Exit Trim

How To Order

EXZ	7	EV	15	KP	626	RHR	PH2	RM	
Series	Core Housing	Function Code	Lever Style	Trim Style	Finish	Door Hand	Manf.	Locking Type	Options
EXZ	0 – Less Core Housing 7 – 7-pin housing; accepts all BEST cores	EV – With key** NV – Without key	14 – Curved w/ return 15 – Contour w/ angle return	KP - Key Pad	626 690 626AM* Satin* 606 613	RHR LHR	VD9** – Von Duprin 98/99 series PH2 – Precision Hardware 2000 series SA8 – Sargent 8000 Series***	RM – Rim MO – Mortise RD – Surface and concealed vertical rods	SH* – Security head screws

*Indicates extra cost option; see below.
 **The EV function (key override) is not available on the Von Duprin Mortise type.
 ***SA8 Only available with Rim Type device. SA8 does not work with EV function (Key Override).

FUNCTION DESCRIPTION	FUNCTION CODE	COMPLETE WITH COMBINATED CORE			LESS CORE
		PATENTED*	PREMIUM	STANDARD	
KEYPAD EZ EXIT TRIM LOCKS:					
EXZ - Exit Trim - single keyed	EV	1607.00	1608.00	1597.00	1536.00
EXZ - Exit Trim - non keyed	NV	N/A	N/A	N/A	1475.00

*Patented pricing shown is for CORMAX patented keying system. Add \$20.00 for BEST Preferred patented keying.

EXTRA COST OPTIONS*	OPTION CODE	ADD-ON
Satin finishes (per lock)	606, 613, etc.	56.00
UltraShield antimicrobial finish	626AM	122.00
Security head screws	SH	21.00



45HG Offline G Series Mortise Locks

How To Order

45HG	7	TV	14	MS	626	RH	
Series	Core Housing	Function Code	Lever Style	Trim Style	Finish	Door Hand	Options
45HG	0** – Less Core Housing 7 – 7-pin housing; accepts all BEST cores	DV – Latch w/key TV – Deadbolt w/key LV – Deadbolt w/o key NV – Latch w/o key	Levers: 3 – Solid tube/return 12* – Solid tube/no return 14 – Curved/return 15 – Contour/angle return 16 – Curved/no return 17* – Gull wing Knobs: 4 – Round Decorative* 50-91	MS**** – Magnetic stripe DV**** – Dual validation (magstripe and keypad) DVA**** – Other cylinder MSA**** – Other cylinder	626 690 626AM* Satin* 606 612 613 619 Bright* 605 611 625	RH RHR LH LHR	8CE* – 8 cell battery holder assy with batteries 4SW – 4 cell shrink wrap battery P2*** – Phillips head screws KOS* – Key override sensor Thick Door* – Specify thickness 7/8** – Flat lip strike TAC/I* – Tactile Lever Inside TAC/O* – Tactile lever Outside TAC/B* – Tactile Lever Both TRK1**** – Track 1 TRK2**** – Track 2 TRK3**** – Track 3 WS – Windstorm Label (NOA Miami-Dade County)

*Indicates extra cost option.

**Indicates cost deduction.

***T15 Torx security screws are supplied standard.

****Must specify track number.

FUNCTION DESCRIPTION	FUNCTION CODE	COMPLETE WITH COMBINATED CORE			LESS CORE
		PATENTED*	PREMIUM	STANDARD	
MAGNETIC STRIPE READER:					
45HG - Single Keyed Latch	DV	1419.00	1418.00	1408.00	1347.00
45HG - Single Keyed Deadbolt	TV	1445.00	1445.00	1435.00	1374.00
45HG - Non-keyed Latch	NV	N/A	N/A	N/A	1286.00
45HG - Non-keyed Deadbolt	LV	N/A	N/A	N/A	1313.00
MAG STRIPE/KEYPAD DUAL VALIDATION READER:					
45HG - Single Keyed Latch	DV	1592.00	1592.00	1582.00	1521.00
45HG - Single Keyed Deadbolt	TV	1623.00	1623.00	1613.00	1552.00
45HG - Non-keyed Latch	NV	N/A	N/A	N/A	1460.00
45HG - Non-keyed Deadbolt	LV	N/A	N/A	N/A	1491.00

*Patented pricing shown is for CORMAX patented keying system. Add \$20.00 for BEST Preferred patented keying.

EXTRA COST OPTIONS*	OPTION CODE	ADD-ON
Satin finishes (per lock)	606, 612, 613, 619 etc.	56.00
Bright finishes (per lock)	605, 611, 625, etc.	110.00
UltraShield antimicrobial finish	626AM	122.00
Thick door	Specify thickness	81.00
Tactile both levers/knobs**	TAC/B	115.00
Tactile outside lever/knob**	TAC/O	58.00
Tactile inside lever/knob**	TAC/I	58.00
7/8" Lip-to-center strike	7/8 LTC	21.00
12, 17 Lever Design	12, 17	63.00
Decorative Lever Design	50-91	202.00
Extended Life Battery	8CE	65.00
Key Override Sensor	KOS	34.00

**Not available on #17 levers.

**COST DEDUCTIONS	OPTION CODE	DEDUCT
Less cylinder option (Deduct from complete price)	0	61.00



9KG Offline G Series Cylindrical Locks

How To Order

9KG	3	7	DV	14	MS	STK	626	
Series	Backset	Core Housing	Function Code	Lever Style	Rose Style	Strike Package	Finish	Options
9KG	3 – 2-3/4" 4* – 3-3/4" 5* – 5"	0*** – Non-IC Prep 6** – 6 pin non-IC cylinder 7 – 7-pin housing; accepts all BEST cores	DV – with key	4 – Round knob 14 – Curved with return 15 – Contour with angle return 16 – Curved without return	MS***** – Magnetic stripe DV***** – Dual validation (magstripe and keypad)	STK - Standard S3 - ANSI S3 - 7/8" Lip to Center Strike S3B* - ANSI (Strike w/ Plastic Box) S3B 7/8* - ANSI (Strike w/ Plastic Box)	626 690 626AM* Satin* 606 612 Bright* 605 625	8CE* – 8 cell battery holder assy with batteries 4SW – 4 cell shrink wrap battery P2**** – Phillips head screws FM – Free Motion 3/4* – 3/4" throw latch 0B** – non-IC zero-bitted KA** – non-IC keyed alike KD** – non-IC keyed different COR*** – Non IC Corbin-Russwin MED*** – Non IC Medeco SAR*** – Non IC Sargent SCH*** – Non IC Schlage YAL*** – Non IC Yale SCHRC*** – Schlage RC (14 & 15 lever only) AL/O* – Abrasive Lever Outside AL/I* – Abrasive Lever Inside AL/B* – Abrasive Lever Both TL/O* – Tactile Lever Outside TL/I* – Tactile Lever Inside TL/B* – Tactile Lever Both TRK1***** – Track 1 TRK2***** – Track 2 TRK3***** – Track 3 WS – Windstorm Label (NOA Miami-Dade County)

* Indicates extra cost option.

** Six-pin cylinder in Schlage "C" keyway included with 0B, KA, KD options. Must specify "6" for core housing.

*** Cylinder not included with COR, MED, SAR, SCH, YAL, or SCHRC options. Must specify "0" for core housing.

****T15 Torx security screws are supplied standard.

*****Must specify track number.

FUNCTION DESCRIPTION	FUNCTION CODE	COMPLETE WITH COMBINATED CORE			LESS CORE	NON-IC CYLINDER 0B, KA, KD
		PATENTED*	PREMIUM	STANDARD		
MAGNETIC STRIPE READER:						
9KG - Single keyed lock	DV	1292.00	1293.00	1282.00	1221.00	1264.00
MAG STRIPE/KEYPAD DUAL VALIDATION READER:						
9KG - Single keyed lock	DV	1475.00	1476.00	1465.00	1404.00	1447.00

EXTRA COST OPTIONS*	OPTION CODE	ADD-ON
Satin finishes (per lock)	606, 612, 613, etc.	56.00
Bright finishes (per lock)	605, 625, 629, etc.	110.00
UltraShield antimicrobial finish	626AM	122.00
3/4" throw latch	3/4	29.00
Special backsets	94KG / 95KG	20.00
Abrasive lever both sides	AL/B	41.00
Abrasive lever outside	AL/O	21.00
Abrasive lever inside	AL/I	21.00
Tactile lever both sides	TL/B	80.00
Tactile lever outside	TL/O	41.00
Tactile lever inside	TL/I	41.00
7/8" Lip-to-center strike	S3 7/8	21.00
Strike with plastic box	S3B or S3B 7/8	2.10
Extended Life Battery	8CE	65.00

* Patented pricing shown is for CORMAX patented keying system. Add \$20.00 for BEST Preferred patented keying.

PART DESCRIPTION	PART NUMBER	PART PRICE
2-3/4" deadlocking latch	8KL3	69.00
3-3/4" deadlocking latch	8KL4	87.00
5" deadlocking latch	8KL5	87.00
Standard strike package	8KS2	6.80
ANSI strike package	8KS3	20.00
Throw member 7-pin	B54200	1.50



EXG Offline G Series Exit Trim

How To Order

EXG	7	EV	15	MS	626	RHR	PH2	RM	
Series	Core Housing	Function Code	Lever Style	Trim Style	Finish	Door Hand	Manf.	Locking Type	Options
EXG	0 – Less Core Housing 7 – 7-pin housing; accepts all BEST cores	EV – With key** NV – Without key	14 – Curved w/ return 15 – Contour w/ angle return	MS**** – Magnetic stripe DV**** – Dual validation (magstripe and keypad)	626 690 626AM* Satin* 606 613	RHR LHR	VD9** – Von Duprin 98/99 series PH2 – Precision Hardware 2000 series SA8 – Sargent 8000 Series***	RM – Rim*** MO – Mortise RD – Surface and concealed vertical rods	SH* – Security head screws TRK1**** – Track 1 TRK2**** – Track 2 TRK3**** – Track 3

*Indicates extra cost option; see below.

**The EV function (key override) is not available on the Von Duprin Mortise type.

***SA8 Only available with Rim Type device. SA8 does not work with EV function (Key Override).

****Must specify track number.

FUNCTION DESCRIPTION	FUNCTION CODE	COMPLETE WITH CORE			LESS CORE LIST PRICE
		PATENTED*	PREMIUM	STANDARD	
MAGNETIC STRIPE READER:					
EXG - Exit Trim - single keyed	EV	1724.00	1725.00	1714.00	1653.00
EXG - Exit Trim - non keyed	NV	N/A	N/A	N/A	1592.00
MAG STRIPE/KEYPAD DUAL VALIDATION READER:					
EXG - Exit Trim - single keyed	EV	1906.00	1907.00	1896.00	1835.00
EXG - Exit Trim - non keyed	NV	N/A	N/A	N/A	1774.00
EXTRA COST OPTIONS*	OPTION CODE				ADD-ON
Satin finishes (per lock)	606, 613, etc.	N/A			56.00
UltraShield antimicrobial finish	626AM				
Security head screws	SH				

*Patented pricing shown is for CORMAX patented keying system. Add \$20.00 for BEST Preferred patented keying.



45HBV Offline V Series Mortise Locks

How To Order

45HBV	7	TV	14	MS	626	RH	
Series	Core Housing	Function Code	Lever Style	Trim Style	Finish	Door Hand	Options
45HBV	0** – Less Core Housing 7 – 7-pin housing; accepts all BEST cores	DV – Latch w/key TV – Deadbolt w/key LV – Deadbolt w/o key NV – Latch w/o key	Levers: 3 – Solid tube/return 12* – Solid tube/no return 14 – Curved/return 15 – Contour/angle return 16 – Curved/no return 17* – Gull wing Knobs: 4 – Round Decorative* 50-91	MS**** – Magnetic stripe DV**** – Dual validation (magstripe and keypad) PH – Proximity HID® PM – Proximity Indala® DVA**** – Dual Validation Adaptation MSA**** – Magstripe Adaptation PHA – Prox HID® Adaptation PMA – Prox Motorola Adaptation SC - HID® iClass®	626 630 690 626AM* 630AM* Satin* 606 612 613 619 Bright* 605 611 625 629	RH RHR LH LHR	8CE* – 8 cell battery holder assy with batteries 4SW – 4 cell shrink wrap battery P2*** – Phillips head screws KOS* – Key override sensor Thick Door* – Specify thickness 7/8"* – Flat lip strike TAC/I* – Tactile Lever Inside TAC/O* – Tactile lever Outside TAC/B* – Tactile Lever Both TRK1**** – Track 1 TRK2**** – Track 2 TRK3**** – Track 3 MWIE – Motorola 26 bit Wiegand H26B – HID 26 bit Wiegand H37B – HID 37 bit Wiegand WS – Windstorm Label (NOA Miami-Dade County)

*Indicates extra cost option.

**Indicates cost deduction.

***T15 Torx security screws are supplied standard.

****Must specify track number.

FUNCTION DESCRIPTION	FUNCTION CODE	COMPLETE WITH COMBINATED CORE			LESS CORE
		PATENTED*	PREMIUM	STANDARD	
MAGNETIC STRIPE READER:					
45HBV - Single Keyed Latch	DV	1639.00	1640.00	1629.00	1568.00
45HBV - Single Keyed Deadbolt	TV	1654.00	1655.00	1644.00	1583.00
45HBV - Non-keyed Latch	NV	N/A	N/A	N/A	1507.00
45HBV - Non-keyed Deadbolt	LV	N/A	N/A	N/A	1522.00
MAG STRIPE/KEYPAD DUAL VALIDATION READER:					
45HBV - Single Keyed Latch	DV	1811.00	1812.00	1801.00	1740.00
45HBV - Single Keyed Deadbolt	TV	1813.00	1814.00	1803.00	1742.00
45HBV - Non-keyed Latch	NV	N/A	N/A	N/A	1679.00
45HBV - Non-keyed Deadbolt	LV	N/A	N/A	N/A	1681.00
HID PROXIMITY READER:					
45HBV - Single Keyed Latch	DV	2204.00	2205.00	2194.00	2133.00
45HBV - Single Keyed Deadbolt	TV	2224.00	2225.00	2214.00	2153.00
45HBV - Non-keyed Latch	NV	N/A	N/A	N/A	2072.00
45HBV - Non-keyed Deadbolt	LV	N/A	N/A	N/A	2092.00
INDALA (MOTOROLA) PROXIMITY READER:					
45HBV - Single Keyed Latch	DV	2374.00	2375.00	2364.00	2303.00
45HBV - Single Keyed Deadbolt	TV	2395.00	2396.00	2385.00	2324.00
45HBV - Non-keyed Latch	NV	N/A	N/A	N/A	2242.00
45HBV - Non-keyed Deadbolt	LV	N/A	N/A	N/A	2263.00

*Patented pricing shown is for CORMAX patented keying system. Add \$20.00 for BEST Preferred patented keying.



45HBV Offline V Series Mortise Locks (continued)

EXTRA COST OPTIONS*	OPTION CODE	ADD-ON
Satin finishes (per lock)	606, 612, 613, 619 etc.	56.00
Bright finishes (per lock)	605, 611, 625, etc.	110.00
UltraShield antimicrobial finish	626AM, 630AM	122.00
Thick door	Specify thickness	81.00
Tactile both levers/knobs**	TAC/B	115.00
Tactile outside lever/knob**	TAC/O	58.00
Tactile inside lever/knob**	TAC/I	58.00
Security head screws	SH	21.00
7/8" Lip-to-center strike	7/8 LTC	21.00
12, 17 Lever Design	12, 17	63.00
Decorative Lever Design	50-91	202.00
Extended Life Battery	8CE	65.00
Key Override Sensor	KOS	34.00

**Not available on #17 levers.

**COST DEDUCTIONS	OPTION CODE	DEDUCT
Less cylinder option (Deduct from complete price)	0	61.00

*Patented pricing shown is for CORMAX patented keying system. Add \$20.00 for BEST Preferred patented keying.



9KBV Offline V Series Cylindrical Locks

How To Order

9KBV	3	7	DV	14	MS	STK	626	
Series	Backset	Core Housing	Function Code	Lever Style	Rose Style	Strike Package	Finish	Options
9KBV	3 – 2-3/4" 4* – 3-3/4" 5* – 5"	0*** – Non-IC Prep 6** – 6 pin non-IC cylinder 7 – 7-pin housing; accepts all BEST cores	DV – with key	4 – Round knob 14 – Curved with return 15 – Contour with angle return 16 – Curved without return	MS***** – Magnetic stripe DV***** – Dual validation (magstripe and keypad) PH – Proximity HID® PM – Proximity Indala® SC – HID® iClass®	STK – Standard S3 – ANSI S3 7/8* – Lip to center strike S3B* - ANSI (Stike w/ Plastic Box) S3B 7/8* - ANSI (Stike w/ Plastic Box)	626 690 626AM* Satin* 606 612 Bright* 605 625	8CE* – 8 cell battery holder assy with batteries 4SW – 4 cell shrink wrap battery P2**** – Phillips head screws FM – Free Motion 3/4* – 3/4" throw latch 0B** – non-IC zero-bitted KA** – non-IC keyed alike KD** – non-IC keyed different COR*** – Non IC Corbin-Russwin MED*** – Non IC Medeco SAR*** – Non IC Sargent SCH*** – Non IC Schlage YAL*** – Non IC Yale SCHRC*** – Schlage RC (14 & 15 lever only) AL/O* – Abrasive Lever Outside AL/I* – Abrasive Lever Inside AL/B* – Abrasive Lever Both TL/O* – Tactile Lever Outside TL/I* – Tactile Lever Inside TL/B* – Tactile Lever Both TRK1***** – Track 1 TRK2***** – Track 2 TRK3***** – Track 3 MWIE – Motorola 26 bit Wiegand H26B – HID 26 bit Wiegand H37B – HID 37 bit Wiegand WS – Windstorm Label (NOA Miami-Dade County)

* Indicates extra cost option.
 ** Six-pin cylinder in Schlage "C" keyway included with 0B, KA, KD options. Must specify "6" for core housing.
 *** Cylinder not included with COR, MED, SAR, SCH, YAL, or SCHRC options. Must specify "0" for core housing.
 **** T15 Torx security screws are supplied standard.
 ***** Must specify track number.

DESCRIPTION	FUNCTION CODE	COMPLETE WITH COMBINATED CORE			LESS CORE	NON-IC CYLINDER 0B, KA, KD
		PATENTED*	PREMIUM	STANDARD		
MAGNETIC STRIPE READER:						
9KBV - Single keyed lock	DV	1491.00	1492.00	1481.00	1420.00	1463.00
MAG STRIPE/KEYPAD DUAL VALIDATION READER:						
9KBV - Single keyed lock	DV	1664.00	1665.00	1654.00	1593.00	1636.00
HID PROXIMITY READER:						
9KBV - Single keyed lock	DV	2061.00	2062.00	2051.00	1990.00	2033.00
INDALA (MOTOROLA) PROXIMITY READER:						
9KBV - Single keyed lock	DV	2219.00	2220.00	2209.00	2148.00	2191.00

EXTRA COST OPTIONS*	OPTION CODE	ADD-ON
Satin finishes (per lock)	606, 612, 613, etc.	56.00
Bright finishes (per lock)	605, 625, 629, etc.	110.00
UltraShield antimicrobial finish	626AM	122.00
3/4" throw latch	3/4	29.00
Special backsets	94KBV / 95KBV	20.00
Abrasive lever both sides	AL/B	41.00
Abrasive lever outside	AL/O	21.00
Abrasive lever inside	AL/I	21.00
Tactile lever both sides	TL/B	80.00
Tactile lever outside	TL/O	41.00
Tactile lever inside	TL/I	41.00
7/8" Lip-to-center strike	S3 7/8	21.00
Strike with plastic box	S3B or S3B 7/8	2.10
Extended Life Battery	8CE	65.00

*Patented pricing shown is for CORMAX patented keying system. Add \$20.00 for BEST Preferred patented keying.

PART DESCRIPTION	PART NUMBER	PART PRICE
2-3/4" deadlocking latch	8KL3	69.00
3-3/4" deadlocking latch	8KL4	87.00
5" deadlocking latch	8KL5	87.00
Standard strike package	8KS2	6.80
ANSI strike package	8KS3	20.00
Throw member 6-pin / 7-pin	71217417 / B54200	1.50



EXBV Offline V Series Exit Trim

How To Order

EXBV	7	EV	15	MS	626	RHR	PH2	RM	
Series	Core Housing	Function Code	Lever Style	Trim Style	Finish	Door Hand	Manf.	Locking Type	Options
EXBV	0 – Less Core Housing 7 – 7-pin housing; accepts all BEST cores	EV – With key** NV – Without key	14 – Curved w/ return 15 – Contour w/ angle return	MS**** – Magnetic stripe DV**** – Dual validation (magstripe and keypad) PH – Proximity HID® PM – Proximity Indala® SC - HID® iClass®	626 690 626AM* Satin* 606 613	RHR LHR	PH2 – Precision Hardware 2000 series VD9** – Von Duprin 98/99 series SA8 – Sargent 8000 Series****	RM – Rim MO – Mortise RD – Surface and concealed vertical rods	SH* – Security head screws TRK1**** – Track 1 TRK2**** – Track 2 TRK3**** – Track 3 MWIE – Motorola 26 bit Wiegand H26B – HID 26 bit Wiegand H37B – HID 37 bit Wiegand

*Indicates extra cost option; see below.

**The EV function (key override) is not available on the Von Duprin Mortise type.

***SA8 Only available with Rim Type device. SA8 does not work with EV function (Key Override).

****Must specify track number.

DESCRIPTION	FUNCTION CODE	COMPLETE WITH COMBINATED CORE			LESS CORE
		PATENTED*	PREMIUM	STANDARD	
MAGNETIC STRIPE READER:					
EXBV - Exit Trim - single keyed	EV	1854.00	1855.00	1844.00	1783.00
EXBV - Exit Trim - non keyed	NV	N/A	N/A	N/A	1722.00
MAG STRIPE/KEYPAD DUAL VALIDATION READER:					
EXBV - Exit Trim - single keyed	EV	2034.00	2035.00	2024.00	1963.00
EXBV - Exit Trim - non keyed	NV	N/A	N/A	N/A	1902.00
HID PROXIMITY READER:					
EXBV - Exit Trim - single keyed	EV	2443.00	2444.00	2433.00	2372.00
EXBV - Exit Trim - non keyed	NV	N/A	N/A	N/A	2311.00
INDALA (MOTOROLA) PROXIMITY READER:					
EXBV - Exit Trim - single keyed	EV	2609.00	2610.00	2599.00	2538.00
EXBV - Exit Trim - non keyed	NV	N/A	N/A	N/A	2477.00

*Patented pricing shown is for CORMAX patented keying system. Add \$20.00 for BEST Preferred patented keying.

EXTRA COST OPTIONS*	OPTION CODE	ADD-ON
Satin finishes (per lock)	606, 613, etc.	56.00
UltraShield antimicrobial finish	626AM	122.00
Security head screws	SH	21.00



45HM IDH MAX™ Mortise Locks

How To Order

45HM	7	DEU	14	MS	626	RH	
Series	Core Housing	Function Code	Lever Style	Trim Style	Finish	Door Hand	Options
45HM	0** – Less Core Housing 7 – 7-pin housing; accepts all BEST cores	DEU – Electrically unlocked DEL – Electrically locked NXEU – Electrically unlocked NXEL – Electrically Locked TDEU – Electrically Unlocked TDEL – Electrically Locked LEU – Electrically unlocked LEL – Electrically locked	Levers: 3 – Solid tube/return 4 – Round 12* – Solid tube/no return 14 – Curved/return 15 – Contour/angle return 16 – Curved/no return 17* – Gull wing Decorative* 50-91	MS**** – Magnetic stripe PH – Proximity HID® PM – Proximity Indala® MSA**** – Magstripe Adaptation PHA – Proximity HID Adaptation PMA – Proximity Motorola Adaptation SC - HID® iClass®	626 630 690 626AM* 630AM* Satin* 606 612 613 Bright* 605 611 625 629	RH RHRB LH LHRB	P2*** – Phillips head screws Thick Door* – Specify thickness 7/8"* – Flat lip strike 1300* – B.A.S.I.S. Direct Connect TAC/I* – Tactile Lever Inside TAC/O* – Tactile lever Outside TAC/B* – Tactile Lever Both MWIE – Motorola 26 bit Wiegand H26B – HID 26 bit Wiegand H37B – HID 37 bit Wiegand TRK1**** - Track 1 TRK2**** - Track 2 TRK3**** - Track 3

* Indicates extra cost; see below.

** Indicates cost deduction; see below.

***T15 Torx security screws are supplied standard.

****Must specify track number.

DESCRIPTION	FUNCTION CODE	COMPLETE WITH COMBINED CORE			LESS CORE
		PATENTED*	PREMIUM	STANDARD	
MAGNETIC STRIPE READER:					
45HM - Single Keyed Latch	DEU, DEL	2039.00	2040.00	2029.00	1968.00
45HM - Non-keyed Latch	NXEU, NXEL	N/A	N/A	N/A	1907.00
45HM - Single Keyed Deadbolt	TDEU, TDEL	2059.00	2060.00	2049.00	1988.00
45HM - Non-keyed Deadbolt	LEU, LEL	N/A	N/A	N/A	1927.00
HID PROXIMITY READER:					
45HM - Single Keyed Latch	DEU, DEL	2628.00	2629.00	2618.00	2557.00
45HM - Non-keyed Latch	NXEU, NXEL	N/A	N/A	N/A	2496.00
45HM - Single Keyed Deadbolt	TDEU, TDEL	2632.00	2633.00	2622.00	2561.00
45HM - Non-keyed Deadbolt	LEU, LEL	N/A	N/A	N/A	2500.00
INDALA (MOTOROLA) PROXIMITY READER:					
45HM - Single Keyed Latch	DEU, DEL	2809.00	2810.00	2799.00	2738.00
45HM - Non-keyed Latch	NXEU, NXEL	N/A	N/A	N/A	2677.00
45HM - Single Keyed Deadbolt	TDEU, TDEL	2814.00	2815.00	2804.00	2743.00
45HM - Non-keyed Deadbolt	LEU, LEL	N/A	N/A	N/A	2682.00
ICLASS SMART CARD READER					
45HM - Single keyed latch	DEU, DEL	2606.00	2607.00	2596.00	2535.00
45HM - Non-Keyed Latch	NXEU, NXEL	N/A	N/A	N/A	2472.00
45HM - Single Keyed Deadbolt	TDEU, TDEL	2627.00	2628.00	2617.00	2556.00
45HM - Non-keyed Deadbolt	LEU, LEL	N/A	N/A	N/A	2493.00

*Patented pricing shown is for CORMAX patented keying system. Add \$20.00 for BEST Preferred patented keying.



45HM IDH MAX™ Mortise Locks (continued)

EXTRA COST OPTIONS*	OPTION CODE	ADD-ON
Satin finishes (per lock)	606, 612, 613, 619 etc.	56.00
Bright finishes (per lock)	605, 611, 625, etc.	110.00
UltraShield antimicrobial finish	626AM, 630AM	122.00
Thick door	Specify thickness	81.00
Tactile both levers/knobs**	TAC/B	115.00
Tactile outside lever/knob**	TAC/O	58.00
Tactile inside lever/knob**	TAC/I	58.00
7/8" Lip-to-center strike	7/8 LTC	21.00
12, 17 Lever Design	12, 17	63.00
Decorative Lever Design	50-91	202.00
Integrated BAS1300/LNL1300 reader electronics board	1300	617.00

**Not available on #17 levers.

1300 Option - Integrated reader electronics board embedded behind the escutcheon, secured and out of sight. This option functions with B.A.S.I.S. / LENEL On Guard on-line equipment only.

** COST DEDUCTIONS	OPTION CODE	DEDUCT
Less cylinder option (Deduct from complete price)	0	61 .00



9KM IDH MAX™ Cylindrical Locks

How To Order

9KM	3	7	DDEU	14	MS	STK	626	
Series	Back-set	Core Housing	Function Code	Lever Style	Rose Style	Strike Package	Finish	Options
9KM	3 – 2-3/4" 4* – 3-3/4" 5* – 5"	0*** – Non-IC Prep 6** – 6 pin non-IC cylinder 7 – 7-pin housing; accepts all BEST cores	DDEU – Electrically unlocked DDEL**** – Electrically locked	14 – Curved with return 15 – Contour with angle return 16 – Curved without return	MS***** – Magnetic stripe PH – Proximity HID® PM – Proximity Indala® SC - HID® iClass®	STK – Standard S3 – ANSI S3 7/8* – Lip to center strike LS – Less Strike S3B* - ANSI (Stike w/ Plastic Box) S3B 7/8* - ANSI (Stike w/ Plastic Box)	626 690 626AM* Satin* 606 612 613 619 622 Bright* 605 611 625	LM – Lost motion P2**** – Phillips head screws 3/4* – 3/4" throw latch 1300* – B.A.S.I.S. Direct Connect COR*** – Non IC Corbin-Russwin MED*** – Non IC Medeco SAR*** – Non IC Sargent SCH*** – Non IC Schlage YAL*** – Non IC Yale SCHRC*** – Schlage RC (14 & 15 lever only) AL/O* – Abrasive Lever Outside AL/I* – Abrasive Lever Inside AL/B* – Abrasive Lever Both TL/O* – Tactile Lever Outside TL/I* – Tactile Lever Inside TL/B* – Tactile Lever Both MWIE – Motorola 26 bit Wiegand H26B – HID 26 bit Wiegand H37B – HID 37 bit Wiegand TRK1***** - Track 1 TRK2***** - Track 2 TRK3***** - Track 3 C-PRE – Terminated Quick Connect Plug

* Indicates extra cost option.
 ** Six-pin cylinder in Schlage "C" keyway included with 0B, KA, KD options. Must specify "6" for core housing.
 *** Cylinder not included with COR, MED, SAR, SCH, YAL, or SCHRC options. Must specify "0" for core housing.
 ****T15 Torx security screws are supplied standard.
 *****DDEL is not available when using 1300 option.
 *****Must specify track number.

FUNCTION DESCRIPTION	FUNCTION CODE	COMPLETE WITH COMBINATED CORE			LESS CORE	NON-IC CYLINDER 0B, KA, KD
		PATENTED*	PREMIUM	STANDARD		
MAGNETIC STRIPE READER						
9KM - Single keyed lock	DDEU, DDEL	1947.00	1948.00	1937.00	1876.00	1919.00
HID PROXIMITY READER						
9KM - Single keyed lock	DDEU, DDEL	2531.00	2532.00	2521.00	2460.00	2503.00
INDALA (MOTOROLA) PROXIMITY READER:						
9KM - Single keyed lock	DDEU, DDEL	2702.00	2703.00	2692.00	2631.00	2674.00
ICLASS SMART CARD READER						
9KM - Single keyed latch	DDEU, DDEL	2606.00	2607.00	2596.00	2535.00	2578.00

*Patented pricing shown is for CORMAX patented keying system. Add \$20.00 for BEST Preferred patented keying.

EXTRA COST OPTIONS*	OPTION CODE	ADD-ON
Satin finishes (per lock)	606, 612, 613, etc.	56.00
Bright finishes (per lock)	605, 625, 629, etc.	110.00
UltraShield antimicrobial finish	626AM	122.00
3/4" throw latch	3/4	29.00
Special backsets	94KM / 95KM	20.00
Abrasive lever both sides	AL/B	41.00
Abrasive lever outside	AL/O	21.00
Abrasive lever inside	AL/I	21.00
Tactile lever both sides	TL/B	80.00
Tactile lever outside	TL/O	41.00
Tactile lever inside	TL/I	41.00
7/8" Lip-to-center strike	S3 7/8	21.00
Strike with plastic box	S3B or S3B 7/8	2.10
Integrated BAS1300/LNL1300 reader electronics board	1300	617.00

1300 Option - Integrated reader electronics board embedded behind the escutcheon, secured and out of sight. This option functions with B.A.S.I.S. / LENEL On Guard on-line equipment only.

PARTS	PART NUMBER	PART PRICE
2-3/4" deadlocking latch	8KL3	69.00
3-3/4" deadlocking latch	8KL4	87.00
5" deadlocking latch	8KL5	87.00
Standard strike package	8KS2	6.80
ANSI strike package	8KS3	20.00
Throw member 6-pin / 7-pin	71217417 / B54200	1.50



STANLEY Wi-Q™ Technology Wireless Access Management Software & Accessories

DESCRIPTION	PART NUMBER	PRICE
Software		
B.A.S.I.S / Wi-Q™ Interface	WQS-BAS-INT	213.00
B.A.S.I.S Stanley Wi-Q™ Reader License	SWG-WIQ-32	2392.00

DESCRIPTION	PART NUMBER	PRICE
Portal Gateways (PG)		
Portal Gateway for up to 64 Readers/Locks* with half wave dipole omnidirectional antenna (should only be used where PG is mounted in an open area, not in a ceiling or restricted signal area).	WQX-PG	1283.00
Portal Gateway for up to 64 Readers/Locks* with ceiling mount omnidirectional antenna.	WQX-PG-C	1495.00
Portal Gateway with enclosure, power supply and ceiling mount omnidirectional antenna	WQX-PG-C-B	1877.00
Portal Gateway in a mounting enclosure, without Power Supply. This would be used with Power Over Ethernet (POE) devices (not included)	WQX-PG-BP	1458.00
Portal Gateway in a mounting enclosure, with ceiling mount omnidirectional antenna, without Power Supply. This would be used with Power Over Ethernet (POE) devices (not included)	WQX-PG-C-BP	1670.00
Portal Gateway for up to 64 Readers/Locks* with wall mount directional antenna	WQX-PG-W	1685.00
Portal Gateway with enclosure, power supply and wall mount directional antenna	WQX-PG-W-B	2067.00

*Does not imply that 64 readers/locks will be within distance/RF range to connect. Total number of portal gateways required is based on individual system survey and requirements.

Wireless Access Controllers (WAC)		
Wireless Access Controller with half wave dipole omnidirectional antenna (should only be used where WAC is mounted in an open area, not in a ceiling or restricted signal area).	WQX-WAC	866.00
Wireless Access Controller with ceiling mount omni directional antenna	WQX-WAC-C	1081.00
Wireless Access Controller in enclosure with power supply and ceiling mount omnidirectional antenna	WQX-WAC-C-B	1462.00
Wireless Access Controller with wall mount directional antenna	WQX-WAC-W	1270.00
Wireless Access Controller in enclosure with power supply and wall mount directional antenna	WQX-WAC-W-B	1652.00
Wireless Access Controller in Nema enclosure with power supply and exterior directional antenna	WQX-WAC-D-BW	2037.00
Wireless Access Controller in Nema enclosure with power supply and exterior omni-directional antenna	WQX-WAC-O-BW	1958.00
Wireless Access Controller sign-on keypad	WQD-WACPAD	456.00
Wireless Access Controller Survey Kit	WQD-Survey	5112.00
Power and adapters		
Sealed battery pack	VPD-BB	35.00
Plug-in Transformer (wall-mount) with 6' of cable	WQD-12827	35.00
Power over Ethernet Power Supply/Inserter	WQD-12927-001	129.00
Power over Ethernet Active Splitter with Isolation	WQD-12928-001	125.00
Stanley Wi-Q™ Antennas & Accessories		
2.4 GHz Interior Ceiling Mount Omni-directional Antenna kit*	WQD-ACMO	273.00
2.4 GHz Interior/Exterior Wall mount directional antenna kit*	WQD-AWMD	461.00
2.4GHZ Exterior directional antenna**	WQD-AEMD	628.00
2.4GHZ Exterior omnidirectional mast mount kit**	WQD-AEMO	498.00
Exterior Antenna Grounding kit***	WQD-AGT	372.00
Surge Protection Kit	WQD-SURG	279.00
Cleaning Cards (box of 50)	VPDCLN	170.00
HID Proximity Card Enrollment Reader	RDR6081AKU	853.00

*Antenna Kit include antenna, standard mount and 20' cable to connect to PG or WAC.

**Antenna Kit includes antenna, wall and post mounts and 20' cable to connect to PG or WAC.

***Grounding Kit includes coax grounding kit and lightning arrester.



BEST 45HQ Wireless Mortise Locks With STANLEY Wi-Q™ Technology

How To Order

45HQ	7	TV	14	MS	626	RH	
Series	Core Housing	Function Code	Lever Style	Trim Style	Finish	Door Hand	Options
45HQ	0** – Less Core Housing 7 – 7-pin housing; accepts all BEST cores	DV – Latch w/key TV – Deadbolt w/key	Levers: 3 – Solid tube/return 12* – Solid tube/no return 14 – Curved/return 15 – Contour/angle return 16 – Curved/no return 17* – Gull wing Knobs: 4 – Round Decorative* 50-91	MS**** – Magnetic stripe DV**** – Dual validation (magstripe and keypad) PH – Proximity HID® PM – Proximity Indala® DVA**** – Other cyl MSA**** – Other cyl PHA – Other cyl PMA – Other cyl SC - HID ® iClass ®	626 630 690 626AM* 630AM* Satin* 606 612 613 Bright* 605 611 625 629	RH RHRB LH LHRB	8CE* – 8 cell battery holder assy with batteries 4SW – 4 cell shrink wrap battery P2*** – Phillips head screws Thick Door* – Specify thickness 7/8"* – Flat lip strike TAC/I* – Tactile Lever Inside TAC/O* – Tactile lever Outside TAC/B* – Tactile Lever Both TRK1**** – Track 1 TRK2**** – Track 2 TRK3**** – Track 3 WS – Windstorm Label (NOA Miami-Dade County)

Note: Wireless locks come with Integrated Door Hardware (IDH) as standard -Request to Exit (RQE), door position switch (DS), latch bolt monitor switch (LS) and key-override switch (KOS) on DV Function.

*Indicates extra cost option.

**Indicates cost deduction.

***T15 Torx security screws are supplied standard.

****Must specify track number.

FUNCTION DESCRIPTION	FUNCTION CODE	COMPLETE WITH COMBINED CORE			LESS CORE
		PATENTED*	PREMIUM	STANDARD	
Magnetic stripe reader					
45HQ- Single Keyed Latch	DV	1942.00	1943.00	1932.00	1871.00
45HQ- Single Keyed Deadbolt	TV	1961.00	1962.00	1951.00	1890.00
Magnetic stripe/keypad dual validation reader					
45HQ- Single Keyed Latch	DV	2141.00	2142.00	2131.00	2070.00
45HQ- Single Keyed Deadbolt	TV	2161.00	2162.00	2151.00	2090.00
HID® Proximity reader					
45HQ- Single Keyed Latch	DV	2276.00	2277.00	2266.00	2205.00
45HQ- Single Keyed Deadbolt	TV	2397.00	2398.00	2387.00	2326.00
Indala® proximity reader					
45HQ- Single Keyed Latch	DV	2505.00	2506.00	2495.00	2434.00
45HQ- Single Keyed Deadbolt	TV	2625.00	2626.00	2615.00	2554.00
iClass Smart Card reader					
45HQ- Single Keyed Latch	DV	2505.00	2506.00	2495.00	2434.00
45HQ- Single Keyed Deadbolt	TV	2625.00	2626.00	2615.00	2554.00

*Patented pricing shown is for CORMAX patented keying system. Add \$20.00 for Best Preferred patented keying.



BEST 45HQ Wireless Mortise Locks With STANLEY Wi-Q™ Technology (continued)

EXTRA COST OPTIONS*	OPTION CODE	ADD-ON
Satin finishes (per lock)	606, 612, 613 etc.	56.00
Bright finishes (per lock)	605, 611, 625 etc.	110.00
UltraShield antimicrobial finish	626AM, 630AM	122.00
Thick door	Specify thickness	81.00
Tactile both levers/knobs**	TAC/B	115.00
Tactile outside lever/knob**	TAC/O	58.00
Tactile inside lever/knob**	TAC/I	58.00
7/8" Lip-to-center strike	7/8 LTC	21.00
12, 17 Lever Design	12, 17	63.00
Decorative Lever Design	50-91	202.00
Extended Life Battery	8CE	65.00

**Not available on #17 levers.

**COST DEDUCTIONS	OPTION CODE	DEDUCT
Less cylinder option (Deduct from complete price)	0	61 .00



BEST 9KQ Wireless Cylindrical Locks With STANLEY Wi-Q™ Technology

How To Order

9KQ	3	7	DV	14	MS	STK	626	
Series	Backset	Core Housing	Function Code	Lever Style	Rose Style	Strike Package	Finish	Options
9KQ	3 – 2-3/4" 4* – 3-3/4" 5* – 5"	0*** – Non-IC Prep 6** – 6 pin non-IC cylinder 7 – 7-pin housing; accepts all BEST cores	DV – with key	14 – Curved with return 15 – Contour with angle return 16 – Curved without return 4 – Round knob	MS***** – Magnetic stripe DV***** – Dual validation (magstripe and keypad) PH – Proximity HID® PM – Proximity Indala® SC - HID ® iClass ®	STK – Standard S3 – ANSI S3 7/8* – Lip to center strike S3B* - ANSI (Stike w/ Plastic Box) S3B 7/8* - ANSI (Stike w/ Plastic Box)	626 690 626AM* Satin* 606 612 Bright* 605 625	8CE* – 8 cell battery holder assy with batteries 4SW – 4 cell shrink wrap battery P2**** – Phillips head screws LM – Lost motion 3/4* – 3/4" throw latch 0B** – non-IC zero-bitted COR*** – non IC Corbin Russwin MED*** – non IC Medeco SAR*** – non IC Sargent SCH*** – non IC Schlage YAL*** – non IC Yale SCHRC*** – Schlage RC (14 & 15 lever only) AL/O* – Abrasive Lever Outside AL/I* – Abrasive Lever Inside AL/B* – Abrasive Lever Both TL/O* – Tactile Lever Outside TL/I* – Tactile Lever Inside TL/B* – Tactile Lever Both TRK1***** – Track 1 TRK2***** – Track 2 TRK3***** – Track 3 WS – Windstorm Label (NOA Miami-Dade County)

Note: Wireless locks come with Integrated Door Hardware (IDH) as standard -Request to Exit (RQE), Door Position Switch (DS)

* Indicates extra cost option.
 ** Six-pin cylinder in Schlage "C" keyway included with 0B, KA, KD options. Must specify "6" for core housing.
 *** Cylinder not included with COR, MED, SAR, SCH, YAL, or SCHRC options. Must specify "0" for core housing.
 ****T15 Torx security screws are supplied standard.
 *****Must specify track number.

FUNCTION DESCRIPTION	FUNCTION CODE	COMPLETE WITH COMBINATED CORE			LESS CORE	NON-IC CYLINDER 0B, KA, KD
		PATENTED*	PREMIUM	STANDARD		
Magnetic Stripe Reader						
9KQ - Single keyed lock	DV	1835.00	1836.00	1825.00	1764.00	1807.00
Mag Stripe Keypad Dual Validation Reader						
9KQ - Single keyed lock	DV	2042.00	2043.00	2032.00	1971.00	2014.00
HID® Proximity Reader						
9KQ - Single keyed lock	DV	2370.00	2371.00	2360.00	2299.00	2342.00
Indala® Proximity Reader						
9KQ - Single keyed lock	DV	2606.00	2607.00	2596.00	2535.00	2578.00
iClass Smart Card Reader						
9KQ - Single keyed lock	DV	2606.00	2607.00	2596.00	2535.00	2578.00

*Patented pricing shown is for CORMAX patented keying system. Add \$20.00 for Best Preferred patented keying.

EXTRA COST OPTIONS*	OPTION CODE	ADD-ON
Satin finishes (per lock)	606, 612, 613, etc.	56.00
Bright finishes (per lock)	605, 625, 629, etc.	110.00
UltraShield antimicrobial finish	626AM	122.00
3/4" throw latch	3/4	29.00
Special backsets	94KQ / 95KQ	20.00
Abrasive lever both sides	AL/B	41.00
Abrasive lever outside	AL/O	21.00
Abrasive lever inside	AL/I	21.00
Tactile lever both sides	TL/B	80.00
Tactile lever outside	TL/O	41.00
Tactile lever inside	TL/I	41.00
7/8" Lip-to-center strike	3S 7/8	21.00
Strike with plastic box	S3B or S3B 7/8	2.10
Extended Life Battery	8CE	65.00

PART DESCRIPTION	PART NUMBER	PRICE
2-3/4" deadlocking latch	8KL3	69.00
3-3/4" deadlocking latch	8KL4	87.00
5" deadlocking latch	8KL5	87.00
Standard strike package	8KS2 / 9KS2	6.80
ANSI strike package	8KS3 / 9KS3	20.00
Throw member 6-pin / 7-pin	71217417 / B54200	1.50



BEST EXQ Wireless Exit Trim With STANLEY Wi-Q™ Technology

How To Order

EXQ	7	EV	15	MS	626	RHR	PH2	RM	
Series	Core housing	Function code	Lever style	Trim style	Finish	Door hand	Mfg	Locking type	Options
EXQ	0 – Less Core Housing 7 – 7-pin housing; accepts all BEST cores	EV – With key**	14 – Curved w/ return 15 – Contour w/ angle return	MS*** – Magnetic stripe DV*** – Dual validation (magstripe and keypad) PH – Proximity HID® PM – Proximity Indala® SC - HID ® iClass ®	626 690 626AM* Satin* 606 612 613	RHR LHR	PH2 – Precision Hardware 2000 series VD9** – Von Duprin 98/99 series	RM – Rim MO – Mortise RD – Surface and concealed vertical rods	SH* – Security head screws MT1*** – Track 1 MT2*** – Track 2 MT3*** – Track 3

Note: Wireless locks come standard with door position switch (DS), connector/input to connect to a RQE switch inside exit device. (RQE switch must be purchased separately for exit device brand and model).

Note: Latch Switch connector is also included for use with a latch switch indicator only on Precision exit devices.

*Indicates extra cost option; see below.

**The EV function (key override) is not available on the Von Duprin Mortise type.

***Must specify track number.

FUNCTION DESCRIPTION	FUNCTION CODE	COMPLETE WITH COMBINATED CORE			LESS CORE
		PATENTED*	PREMIUM	STANDARD	
Magnetic Stripe Reader					
EXQ - Exit Trim - single keyed	EV	2234.00	2235.00	2224.00	2163.00
Mag Stripe Keypad Dual Validation Reader					
EXQ - Exit Trim - single keyed	EV	2444.00	2445.00	2434.00	2373.00
HID® Proximity Reader					
EXQ - Exit Trim - single keyed	EV	2847.00	2848.00	2837.00	2776.00
Indala® Proximity Reader					
EXQ - Exit Trim - single keyed	EV	3058.00	3059.00	3048.00	2987.00
iClass Smart Card Reader					
EXQ - Exit Trim - single keyed	EV	3058.00	3059.00	3048.00	2987.00

*Patented pricing shown is for CORMAX patented keying system. Add \$20.00 for Best Preferred patented keying.

EXTRA COST OPTIONS*	OPTION CODE	ADD-ON
Satin finishes (per lock)	606, 612, 613	56.00
UltraShield antimicrobial finish	626AM	122.00
Security head screws	SH	21.00



BEST Wireless Conversion Kits With STANLEY Wi-Q™ Technology

How To Order

Kit works on B.A.S.I.S. 9K and 40H Platforms
Works on Magnetic Stripe, Dual Validation, HID® Proximity, and Indala® Proximity
Kits will not work on 30H Mortise Platforms.

SERIES STYLE	DESCRIPTION	PRICE
WQCNKT-1 Cylindrical wireless upgrade kit		
WQCNKT-1 Cylindrical wireless upgrade kit	Kit to convert a B.A.S.I.S. 9K V/G standalone lockset to a Stanley Wi-Q™ Wireless Lockset. Notes: 1) Kit includes a new 9K chassis with new motor, RQE hub and door position switch. 2) If the conversion kit will be used on a pre-2009 standalone lock with a HID Proximity Reader, it is highly recommended that a new HID Proximity reader is also purchased. The new style reader will provide better battery life than the pre-2009 HID Proximity Readers. (Part # 731328545---B82399 45HQ HID PROX BEZEL SUB-ASSY HID)	1277.00
WQCNKT-2 Mortise DV function (without deadbolt) wireless upgrade kit with alarm functionality	Kit to convert a B.A.S.I.S. 45H V/G standalone lockset to a Stanley Wi-Q™ Wireless Lockset. Notes: 1) Kit also contains a new 45H DV mortise case which includes RQE, door position switch, latch position switch and key-override sensor to provide for full alarm functionality. 2) If the conversion kit will be used on a pre-2009 standalone lock with a HID Proximity Reader, it is highly recommended that a new HID Proximity reader is also purchased. The new style reader will provide better battery life than the pre-2009 HID Proximity Readers. (Part # 731328545---B82399 45HQ HID PROX BEZEL SUB-ASSY HID)	1308.00
WQCNKT-3 Mortise TV function (with deadbolt) wireless upgrade kit with alarm functionality	Kit to convert a B.A.S.I.S. 45H V/G standalone lockset to a Stanley Wi-Q™ Wireless Lockset. Notes: 1) Kit also contains a new 45H TV mortise case which includes RQE, door position switch, deadbolt position switch, and key-override sensor to provide for full alarm functionality. 2) If the conversion kit will be used on a pre-2009 standalone lock with a HID Proximity Reader, it is highly recommended that a new HID Proximity reader is also purchased. The new style reader will provide better battery life than the pre-2009 HID Proximity Readers. (Part # 731328545---B82399 45HQ HID PROX BEZEL SUB-ASSY HID)	1370.00

Upgrade kits must be installed by a STANLEY Certified Technician for warranty purposes.



STANLEY ID Express Station™

Remote Card Encoding System

The Stanley ID Express Station™ system provides the ability for cardholders to conduct self-managed transactions via a simple and user-friendly interface at a kiosk station. Existing cards can be updated, or temporary cards can be issued. The Stanley ID Express Station™ is only compatible with the B.A.S.I.S. Access Control Software.

PART NUMBER	DESCRIPTION	PRICE
SSK-IDEXPRESS-K	Stanley ID Express Station™ - Kiosk configuration with 17" Touchscreen monitor, magnetic stripe card dispenser/enrollment station, verification CCTV and Uninterruptible Power Supply, (see note regarding shipping/crating costs)*	39103.00
SSK-IDEXPRESS-DC	Stanley ID Express Station™ - Desktop Complete Configuration with Touchscreen monitor, magnetic stripe card dispenser/enrollment station and verification CCTV. Uninterruptible Power Supply is not included. An exterior placed UPS is recommended. (see note regarding shipping/crating costs)**	31549.00
SSK-IDEXPRESS-PROX	Additional Proximity card enrollment station for the K option Kiosk configuration	1121.00
SSK-IDEXPRESS-Logo	Placement of Customers LOGO on top of Kiosk. Customer must provide art-ready graphic in electronic format	592.00
LE-SWG-1140***	OpenIT Software Module	8842.00

Shipping/crating Charges:

*The above unit pricing does not include the crating charge of \$350 and the shipping cost of \$375 per Kiosk purchase. These amounts are in addition to the per unit pricing. (additional rates apply outside of Contiguous United States)

**The above unit pricing does not include the crating charge of \$250 and the shipping cost of \$275 per Desktop purchase. These amounts are in addition to the per unit pricing. (additional rates apply outside of Contiguous United States)

***Applications utilizing dual validation locks (Card and Pin) will also require the OpenIT software module for the B.A.S.I.S management system. Refer to the Technical Support Group section for installation pricing.

Installation Requirement:

(Provided by Others) Electrical: Requires one (1) standard duplex 110VAC 30 amp circuit located within 2' of the equipment. Communications: Data Connection: Ethernet terminated with a RJ45 located within 2' of the equipment



Electronic Lock Inside Escutcheon Conversion Kits

How To Order

**Kit works on Keypad EZ, B.A.S.I.S. G, B.A.S.I.S. V, NT500, and Wi-Q products.
Kits do not work on IDH Max products.**

Cylindrical Conversion Kits

9KEKT		DV	626	
Series	Wireless or non-wireless	Function Code	Finish	Options
9KEKT – Cylindrical conversion kit	Q – Wi-Q Wireless Blank – Non-wireless	DV – Latch w/key	626 626AM* Satin* 606 612 613 Bright* 605 625 629	8CE* – 8 cell battery holder assy with batteries 4SW – 4 cell shrink wrap battery pack P2** – Phillips head screws

*Indicates extra cost option; see below.

**T15 Torx security screws are supplied standard.

Mortise Conversion Kits

45HEKT	Q	TV	606	
Series	Wireless or non-wireless	Function Code	Finish	Options
45HEKT – Mortise conversion kit	Q – Wi-Q Wireless Blank – Non-wireless	DV – Latch w/key TV – Deadbolt w/key LV – Deadbolt w/o key NV – Latch w/o key	626 626AM* Satin* 606 612 613 Bright* 605 625 629	8CE* – 8 cell battery holder assy with batteries Thick Door* – Specify thickness P2** – Phillips head screws 4SW – 4 cell shrink wrap battery pack

*Indicates extra cost option; see below.

**T15 Torx security screws are supplied standard.

CONVERSION KIT	PRICE
9KEKT Cylindrical conversion kit	
Wi-Q Wireless	223.00
Non-wireless	105.00
45HEKT Mortise conversion kit	
Wi-Q Wireless	223.00
Non-wireless	105.00

EXTRA COST OPTIONS*	OPTION CODE	ADD-ON
Satin finish	606 612 613	56.00
Bright finish	605 625 629	110.00
UltraShield antimicrobial finish	626AM	122.00
Thick door	Specify thickness	81.00
Extended Life Battery	8CE	65.00

OMNILOCK®

WIRELESS

45HOM OMNILOCK Wireless Mortise Locks

How To Order

45HOM	7	DV	15	MDVW	H	B	626	RH	
Series	Core Housing	Function Code	Lever Style	Trim Style	Rose	Housing Finish	Finish	Door Hand	Options
45HOM	0 – Dummy Cylinder 7 – With IC Cylinder (core not included)	DV – Latch w/key TV – Deadbolt w/key	Levers: 3 – Tubular/return 14 – Curved/return 15 – Contour/angle return 16 – Curved/no return	MDVW – Dual validation (magstripe and keypad) KW - Keypad Reader MSW – Magnetic stripe PDVW - Dual Validation (HID Proximity and keypad) PHW – Proximity HID®	H	G - Grey B - Black C* - Satin Chrome	613 626 690 Satin 612*	RH RHR LH LHR	DSR* - Door Switch Monitor & RQE RQE* - Request to Exit KOS* - Key override bypass switch LSM* - Latch Switch Monitor Thick Door* - Specify Thickness W* - Weatherized Version (-4°F to +129°F) 7/8 LTC* - Flat Lip Strike WS – Windstorm Label (NOA Miami-Dade County)

Standard Trim is for indoor use only. (W) option is for -4°F to +129°F.

*Indicates extra cost option

FUNCTION DESCRIPTION	FUNCTION CODE	WITH CYLINDER	LESS CYLINDER
Dual validation reader magnetic stripe and keypad			
45HOM- Single Keyed Latch	DV	2,542.00	2,479.00
45HOM- Single Keyed Deadbolt	TV	2,566.00	2,503.00
Keypad reader			
45HOM- Single Keyed Latch	DV	2,512.00	2,449.00
45HOM- Single Keyed Deadbolt	TV	2,538.00	2,475.00
Magnetic stripe reader			
45HOM- Single Keyed Latch	DV	2,512.00	2,449.00
45HOM- Single Keyed Deadbolt	TV	2,538.00	2,475.00
HID proximity dual validation reader			
45HOM- Single Keyed Latch	DV	2,739.00	2,676.00
45HOM- Single Keyed Deadbolt	TV	2,762.00	2,699.00
HID® Proximity reader			
45HOM- Single Keyed Latch	DV	2,708.00	2,645.00
45HOM- Single Keyed Deadbolt	TV	2,734.00	2,671.00

EXTRA COST OPTIONS*	OPTION CODE	ADD-ON
Satin finishes (per lock)	612	61.00
Satin Chrome Housing Finish	C	96.00
Thick door	Specify thickness	66.00
Key Override Sensor	KOS	159.00
Door Switch Monitor & RQE	DSR	159.00
Latch Switch Monitor	LSM	54.00
Weather Option	W	159.00
Request to Exit	RQE	156.00

OMNILOCK®

WIRELESS

9KOM OMNILOCK Wireless Cylindrical Locks

How To Order

9KOM	3	7	DV	15	MDVW	B	S3	626	
Series	Backset	Core Housing	Function Code	Lever Style	Trim Style	Housing Finish	Strike Package	Finish	Options
9KOM	3 – 2-3/4" 4* – 3-3/4" 5* – 5"	0** – Non-IC Prep 7 - BEST IC Handle (no core)	DV – with key	4 – Knob 14 – Curved with return 15 – Contour with angle return 16 – Curved without return	MDVW – Dual validation (mag-stripe and keypad) KW - Keypad Reader MSW – Magnetic stripe PDVW - Dual Validation (HID Proximity and keypad) PHW – Proximity HID®	G - Grey B - Black C* - Satin Chrome	STK – Standard S3 – ANSI 7/8 LTC* - Flat Lip Strike	613* 626 690 Satin 612*	ATB - Alternate through-bolt mounting DSR* - Door Switch Monitor & RQE RQE* - Request to Exit W* - Weatherized Version (-4°F to +129°F) COR** - non IC Corbin Russwin MED** - non IC Medeco SAR** - non IC Sargent SCH** - non IC Schlage YAL** - non IC Yale SCHRC** - Schlage large format removable core (14 & 15 lever only) WS – Windstorm Label (NOA Miami-Dade County)

Standard Trim is for indoor use only. (W) option is for -4°F to +129°F.

* Indicates extra cost option.

** Cylinder/core not included with COR, MED, SAR, SCH, YAL, or SCHRC options. Must specify "0" for core housing.

FUNCTION DESCRIPTION	TRIM STYLE	PRICE
Dual Validation magstripe and keypad reader		
9KOM Dual validation reader	MDVW	2,099.00
Keypad Reader		
9KOM - Keypad reader	KW	2,099.00
Magnetic Stripe Reader		
9KOM - Magnetic Stripe Reader	MSW	2,099.00
Dual Validation HID Proximity and keypad reader		
9KOM - Proximity dual validation reader	PDVW	2,330.00
HID Proximity Card Reader		
9KOM - Proximity card reader	PHW	2,330.00

EXTRA COST OPTIONS*	OPTION CODE	ADD-ON
Satin finishes (per lock)	612, 613	61.00
Satin Chrome Housing Finish	C	96.00
Door Switch Monitor & RQE	DSR	159.00
Weather Option	W	159.00
2-3/4" deadlocking latch	8KL3	69.00
3-3/4" deadlocking latch	8KL4	87.00
5" deadlocking latch	8KL5	87.00
Request to Exit	RQE	156.00
7/8" Lip-to-center strike	3S 7/8	21.00
Strike with plastic box	S3B or S3B 7/8	2.10

OMNILOCK®

WIRELESS

OMEM OMNILOCK Electric Modules

How To Order

OMEM	C	MDVW	B	
Backset	Lockset Type	Trim Style	Housing Finish	Options
OMEM	C – Cylindrical M – Mortise	MDVW – Dual validation (magstripe and keypad) PDVW – Dual validation (HID Proximity and keypad) Note: Proximity Only and Keypad only are not available	G – Grey B – Black C* – Satin Chrome	W* – Weatherized Version

Standard Trim is for indoor use only. (W) option is for -4°F to +129°F.

* Indicates extra cost option.

NOTE: Lock Chassis with levers is NOT included

FUNCTION DESCRIPTION	FUNCTION CODE	OMNILOCK TRIM ONLY
Cylindrical Dual Validation magstripe and keypad reader		
OMEMC Cylindrical reader	MDVW	1,439.00
Mortise Dual Validation magstripe and keypad reader		
OMEMM Mortise reader	MDVW	1,454.00
Cylindrical Dual Validation HID Proximity and keypad reader		
OMEMC - Cylindrical reader	PDVW	1,617.00
Mortise Dual Validation HID Proximity and keypad reader		
OMEMM - Mortise reader	PDVW	1,631.00
EXTRA COST OPTIONS*		
Weather Option	W	159.00
Satin Chrome Housing Finish	C	96.00

OMNILOCK[®]

WIRELESS

OMWMS OMNILOCK Wall Mount Systems

How To Order

OMWMS	BE	MDVW	B	
Backset	Core Housing	Trim Style	Housing Finish	Options
OMWMS	BE – (5E Cylinder is included, keyed independently with 2 keys)**	MDVW – Dual validation (magstripe and keypad) PDVW - Dual Validation (HID Proximity and keypad)	G - Grey B - Black C* - Satin Chrome	W* - Weatherized Version

Standard Trim is for indoor use only. (W) option is for -4°F to +129°F.

* Indicates extra cost option.

**5E Included with Price of Wall Mount Unit

Note: Each lock is keyed differently. Must special order to key alike. (Additional Net \$52.50 per order for keyed alike options)

FUNCTION DESCRIPTION	FUNCTION CODE	PRICE
Dual Validation magstripe and keypad reader		
OMWMS Dual validation reader	MDVW	1,778.00
Dual Validation HID Proximity and keypad reader		
OMWMS – Proximity dual validation reader	PDVW	1,996.00

EXTRA COST OPTIONS*	OPTION CODE	ADD-ON
Weather Option (-4°F to +129°F)	W	159.00
Satin Chrome Housing Finish	C	96.00

OMNILOCK®

WIRELESS

QASOM Quick Adapter for Pre-2004 Cylindrical Schlage D Lever Locks

How To Order

QASOM	DVW	G	W
Quick Adaptor	Trim Style	Housing Finish	Options
QASOM	MDVW – Dual validation (magstripe and keypad) PDVW – Dual Validation (HID Proximity and keypad)	G – Grey B – Black C* – Satin Chrome	W* – Weatherized Version

Standard Trim is for indoor use only. (W) option is for -4°F to +129°F.

* Indicates extra cost option.

FUNCTION DESCRIPTION	FUNCTION CODE	PRICE
Dual Validation Reader (magnetic stripe and keypad)		
QASOM Quick adapter with DV	MDVW	1,936.00
HID Proximity Dual Validation reader (prox and keypad)		
QASOM Quick adapter with proximity and keypad	PDVW	2,176.00

EXTRA COST OPTIONS*	OPTION CODE	ADD-ON
Weatherized Option (-4°F to +129°F)	W	159.00
Satin Chrome Housing Finish	C	96.00

OMNILOCK®

WIRELESS

QAXOM OMNILOCK Wireless Quick Adapter for Exit Devices

How To Order

QAXOM	7	15	MDVW	B	626	PH2	RHRB	
Quick Adapter	Cylinder Housing	Lever Style	Trim Style	Housing Finish	Lever Finish	Adaptor Plate	Hand	Options
QAXOM	0 - Non-IC Handle (core not included) 7 BEST IC Handle (core not included)	14 – Curved/return 15 – Contour/angle return	MDVW – Dual validation (magstripe and keypad) KW – Keypad Reader MSW – Magnetic stripe PDVW - Dual Validation (HID Proximity and keypad) PHW – Proximity HID®	G – Grey B – Black C* – Satin Chrome	626 612 613	CY1 – Corbin/Russwin Yale Series** PH2 – Precision Hardware series** SA7 – Sargent 88 Series** SA8 – Sargent 88 Series** SA9 – Sargent 98 Series** VD9 – Von Duprin 98/99F series**	RHR LHR	W* – Weatherized

Standard Trim is for indoor use only. (W) option is for -4°F to +129°F.

* Indicates extra cost option.

** Adapter Plate ships same color as housing finish

FUNCTION DESCRIPTION	FUNCTION CODE	PRICE*
Dual Validation Reader (magnetic stripe and keypad)		
QAXOM Quick adapter with DV	MDVW	2,548.00
Keypad Reader only		
QAXOM Quick adapter with keypad only	KW	2,513.00
Magnetic Stripe Reader		
QAXOM Quick adapter with Magnetic stripe reader	MSW	2,513.00
HID Proximity Dual Validation reader (prox and keypad)		
QAXOM Quick adapter with proximity and keypad	PDVW	2,808.00
HID Proximity card reader		
QAXOM Quick adapter with proximity card reader	PHW	2,808.00

*Core not included

EXTRA COST OPTIONS*	OPTION CODE	ADD-ON
Weatherized Option (-4°F to +129°F)	W	159.00
Satin Chrome Housing Finish	C	96.00
Thick Door - Specify Thickness	Thick Door	66.00

ADAPTER PLATE CONVERSION CHART		
Adapter Plate	VON DUPRIN EXIT DEVICE MODEL #	VON DUPRIN TRIM MODEL #
VD9	98F, 99F, 9827-F, 9927-F, 9847-F, 9947-F, 9848-F, 9948-F	990 DT, 990 NL, 110 NL, 990 TP, 991 K, 992 L, 696 NL, 697 NL, 696 TP, 697 TP, 996 DT, 997 DT
	PRECISION EXIT DEVICE MODEL #	PRECISION TRIM MODEL #
PH2	FL-1100 or 2100	1700
PH2	FL-1200 or 2200	2000
PH2	FL-1700 or 2700	3900
PH2	FL-1800 or 2800	1700 / 3900
	CORBIN RUSSWIN/YALE EXIT DEVICE MODEL #	CORBIN RUSSWIN/YALE TRIM MODEL #
CY1	ED5200A / 7100F	755, 759 / 526F, 526F
CY1	ED5470B / 7170F90	955, 957 / 626F, 627F
CY1	ED5860B / 7160F90	1310, 1355, 1357 / 535F, 533F, 532F
	SARGENT/ARROW EXIT DEVICE MODEL #	SARGENT/ARROW TRIM MODEL #
SA7	12-8800	ET, 88C-L, 88D-L, 88K-L, 88L-L, FLL, FLW, MAL, PTB
SA8	12-8888	STS
SA9	12-9800	ET, FLL, FLW, MAL, PTB, STS

OMNILOCK[®]

WIRELESS

Access Control System Parts and Accessories

DESCRIPTION	PART NUMBER	LIST PRICE
Magnetic Card and Proximity Card Encoders and enrollment stations		
Track 2 magnetic stripe enrollment reader	OMD-11274	489.00
Tracks 1,2 and 3 magnetic stripe encoder	MSR20633BA	3,498.00
Proximity Card enrollment reader	OMD-11507-002	853.00
Magnetic Cards, Proximity Cards, Fobs and Prox Tags		
Track-2 Magnetic-Stripe Card, pre-programmed	OMD-10983-002	22.00
Track-2,3 Magnetic Stripe Card, non-programmed	OMD-10983-001	22.00
Track-2 Default Master ID Card	OMD-10983-003	19.00
Track-3 Magnetic-Stripe Card, pre-programmed	OMD-10983-004	19.00
Track-3 Default Master ID Card	OMD-10983-005	19.00
Cleaning Cards - Box of 50	VDPCLN	174.00
Prox Card II Card, Default Programmer Card	OMD-11879	14.00
Prox Card II, no Logo, related User ID Mark printed on card	OMD-11676-001	29.00
Prox Fob, Related User ID on Fob	OMD-11678-001	22.00
HID 1391 Proximity Tag, no external marking printed on tag.	OMD-11677-001	22.00
IsoProx Card II, Graphic Quality, Blank both sides, Related inkjet number printed on card	OMD-12312	30.00
DuoProx Card II, Graphic Quality, Blank front side, Magnetic Stripe on back, Related inkjet number printed on non-programmed card	OMD-12311	30.00
Replacement Batteries		
Battery Pack, twin 'AA', Weatherized, set of two battery packs, For Option W only (-20 to +58 degrees Celsius)	OMD-12000	45.00
Battery Pack, Lithium, OM250	OMD-6610	69.00
Weather covers and plates		
Weatherized Shroud, Stainless	OMD-12911	368.00
Steel Gate Adapter	OMD-12293	134.00
Stainless Steel Flat Adapter Plate for cylindrical locks (1 each)	OMD-12061	67.00
Locknetics Cover Plate (626) covers CM-series cylindrical holes	OMD-11586	25.00

OMNILOCK WAMS Demo Kit

NAME	DESCRIPTION	PART NUMBER	LIST PRICE
Wireless Survey Kit	Portal Gateway, telescopic mast with Omnidirectional antenna, 802.11 Wireless Router, 3 Wireless Door Beacons, Pelican Case.	WQD-Survey	5,112.00

OMNILOCK®

WIRELESS

Non-Best Chassis for OMEM

Schlage ND Series		RHO	L		List Price 626, 605, 606, 613, 612	List Price KOS	
Series	Function Code	Lever Style	PREMIUM			(Key Over-ride Sensor)	
OMSCH	ND80	ATH – Athens OME – Omega RHO – Rhodes SPA – Sparta	P – Standard Schlage C Keyway uncombined core J – Schlage large format IC handle - NO CORE L – LESS Standard core B – BEST format IC handle - NO CORE			1,867.00	136.00

Schlage L Series		06	A	L	RH	KOS	List Price 626, 605, 606, 613, 612	List Price KOS
Series	Function Code	Lever Style	Rose	Cylinder Prefix	Door Hand	Options	(Key Over-ride Sensor)	
OMSCH	L9070 – Mortise with latch	03 – Tubular 06 – Contour/angle return 07 – Curved/no return 17 – Curved/return	A – 2 1/8" Diameter B – 2 9/16" Diameter	P – Standard Schlage Cylinder C Keyway uncombined L – LESS cylinder	RH – Right hand LH – Left hand RHR – Right hand reverse LHR – Right hand reverse	KOS – Key override bypass switch by Stanley	2,289.00	58.00
	L9453 – Storeroom Mortise with Dead-bolt	03 – Tubular 06 – Contour/angle return 07 – Curved/no return 17 – Curved/return	A – 2 1/8" Diameter B – 2 9/16" Diameter	P – Standard Schlage Cylinder C Keyway uncombined L – LESS cylinder	RH – Right hand LH – Left hand RHR – Right hand reverse LHR – Right hand reverse	KOS – Key override bypass switch by Stanley	2,337.00	58.00

Schlage Mortise Cases Only for Omnilock - NO TRIM IS SUPPLIED (3-4 Week Delivery)			List Price	List Price KOS
Part #	Hand	Description	(Key Over-ride Sensor)	
L9070S	RH – Right hand	Schlage L9070 Omnilock Style Case without deadbolt - This is the body only, no trim is supplied	2,023.00	58.00
L9453S	RH – Right hand	Schlage L9453 Omnilock Style Case with deadbolt - This is the body only, no trim is supplied	2,332.00	58.00

OMNILOCK®

WIRELESS

OMNILOCK Software

DESCRIPTION	PART NUMBER	PRICE
Omnilock Wireless Access Management Software-WAMS	QMS-12418-001	734.00

** Current maximum capacity of Card Holders at any one wireless reader is 14,000 unique ID's

**Systems sizes above 1024 Wireless Readers are supported. Host may require larger hard drive support for effective data base / file management.

** Windows 7 is acceptable for small systems, mid to large systems may require Windows Server 2008

Wireless Components

DESCRIPTION	PART NUMBER	PRICE
Single Door Controllers		
Single Door Controller sign-on keypad (required to sign-on a SDC)	WQD-WACPAD	456.00
Portal Gateway and Single Door Controller Antennas		
2.4 GHz Interior Ceiling Mount Omni directional Antenna kit*	WQD-ACMO	273.00
2.4 GHz Interior/Exterior Wall mount directional antenna kit*	WQD-AWMD	461.00
2.4GHZ Exterior omni directional mast mount kit**	WQD-AEMO	498.00
Backside Antenna Kit	731142855	208.00

* Antenna Kit include antenna, standard mount and 20' cable to connect to Gateway.

** Antenna Kit includes antenna, wall and post mounts and 20' cable to connect to SDC or PG's

Conversion Kit (converts Omnilock non-wireless to wireless)		
Kits consist of Wireless Circuit Board and an RF Transceiver antenna Kit. (non-weatherized)	OMD-12657-01	753.00
Transformer - POE Devices - Modem		
Plug in Transformer (wall-mount) with 6' of cable	OMD-12827	37.00
Power over Ethernet Power Supply/Inserter	OMD-12927-001	129.00
Power over Ethernet Active Splitter with Isolation	OMD-12928-001	125.00



PAC Starter and Expansion Kits

PART NUMBER	DESCRIPTION	LIST PRICE
PAC Starter and Expansion Kits		
7220883 PAC 512IP Starter Kit	STANLEY PAC Standard Edition Software w/CD PAC 512IP & Locking Enclosure, 3.0A P/S (2) STANLEY OneProx GS3 MT Mullion Reader GS3 MT Admin Kit Identive ISO 26bit 125kHz card 20 pk	2,526.00
7220885 512IP Expansion Kit	PAC 512IP & Locking Enclosure, 3.0A P/S (2) STANLEY OneProx GS3 MT Mullion Reader	2,039.00
7220886 512 Expansion Kit	PAC 512 & Locking Enclosure, 3.0A P/S (2) STANLEY OneProx GS3 MT Mullion Reader	1,625.00

PART NUMBER	DESCRIPTION	LIST PRICE
7200494	PAC 512 DIN Mount	1,064.00
7219096	PAC 512 IP DIN Mount	1,410.00
7200450	PAC 512 & Locking Enclosure, 3.0A P/S	1,436.00
7200495	PAC 512IP & Locking Enclosure, 3.0A P/S	1,729.00
7213461	GS3 MT Admin Kit	400.00
7213458	STANLEY OneProx GS3 MT Mullion Reader	320.00
7213459	STANLEY OneProx GS3 MT Standard Reader	382.00
7213460	STANLEY OneProx GS3 MT Pin & Prox Reader	425.00
7213462	STANLEY OneProx GS3 LF Vandal Reader	322.00
7200967	STANLEY PAC Standard Edition Software w/CD	585.00
7219105	4 -WAY DIN-Rail Enclosure	201.00
7219106	6 -WAY DIN-Rail Enclosure	453.00
7212682	PAC 500 Access & Alarm Server DIN Mount	1,489.00
7221210	PAC 500 & Locking Enclosure, 3.0A P/S	1,782.00
7221211	PAC 520 Input Controller DIN Mount	1,197.00
7211344	PAC 530 Output Controller DIN Mount	1,223.00
7219107	Identive ISO 26bit 125kHz card 20 pk	118.00
7219104	Identive ISO 26bit 125kHz card 50 pk	266.00
7219097	Identive ISO 26bit 125kHz card 100 pk	554.00
7219108	Identive 26bit 125kHz FOB 20 pk	144.00



QUOTING & ORDERING

Price quotations are based on one (1) shipment to one (1) location, and are valid as identified in the quote but in no case longer than one year from the date of the quote. All exceptions will be evaluated on an individual basis.

All quotation requests will be provided by the Stanley Representative where the project is located.

QUOTING PROCESS AND PROCEDURES: The following information is necessary to secure a price quotation from Stanley.

- Distributor Name
- Distributor Location
- Distributor Contact Name & Phone Number
- Distributor e-mail contact
- Project Name
- Project Location
- Bid Date
- Architects Name, Phone Number, and Architects Location
- Specification Writer Name, Phone Number and Location
- Competitive Influence / Specification
- List of materials to be quoted

Every attempt will be made by Stanley to provide the price quotation in a timely manner. Upon completion, you will receive a copy of the quotation which will also include a valid quotation number. Once the project is secured, a copy of the quotation must accompany your purchase order and be forwarded to Stanley Customer Service Department in Indianapolis for processing.

NON-STANDARD PRODUCT REQUEST: Please contact your Stanley Representative to complete a Non-Standard Product Request Form. All requests should be submitted to the following email address:

Email: product_request@sbdinc.com

Upon receipt of a special order request, Stanley will review the configuration and determine if Stanley is capable of making the special order product and will provide a response to the customer. If Stanley is able to make the special order product, Stanley will provide a specific sku/configuration to the customer for the special order product. This sku/configuration must be identified on all Purchase Orders. In addition, the Purchase Order must be marked as a "Special Order".

ORDERING: The following information is required for Stanley to successfully process any order:

- Itemized Purchase Order (PO)
- Stanley Approved Quote

Please send all orders to SSSCHOrderEntry@sbdinc.com or by fax to 877-835-1030

NOTE: for detailed information on how to place an order for Stanley Best products as well as Stanley masterkey services please see the detailed section regarding "Stanley Best Ordering".

ADD ON ORDERS FOR QUOTED PROJECTS: To place an add-on order from a quoted project the Distributor must include the original quote, PO number and/or Stanley's original order number. Add-On orders will be accepted for a period one (1) year from the original order date. Add-On orders received that are outside of the aforementioned period will be forwarded to the Stanley Representative for re-quote.

STOCKING ORDERS: All orders for stock replenishment should be marked as "Stock" and indicate a "Ship To" address that coincides with the stocking Distributor warehouse location.

INCOMPLETE ORDER PROCESS: All orders are screened upon receipt for complete information. If an order is received incomplete, Stanley Customer Service will make one (1) attempt to contact a Distributor directly for the missing requirements. If the information is not made available to Stanley at that time the order will be referred to the local Stanley Representative for resolution. All incomplete orders will be cancelled if not resolved after sixty (60) calendar days.

PRICE DISCREPANCY PROCESS: All entered orders are reviewed by Stanley Customer Service for accuracy and pricing consistency between the Distributor and Stanley. Any order determined by Stanley, in its sole and absolute discretion, to have a value greater than the Total Price shown on the Distributor purchase order will be held by Stanley for a Price Discrepancy. Stanley quotes are also reviewed to ensure that they are complete, approved, and match the PO. Due to pricing sensitivity, all price discrepancies must be resolved exclusively by your Stanley Representative.

ORDER CANCELLATION/CHANGES: All requests for Order Cancellations and Changes (Quantity, Shipping, Finish, Function, etc) should be sent directly to Stanley Customer Service. Requests via phone will be accepted, but must be accompanied by a written request. Factory Order Number, PO Number, Account Info, and Detailed Changes must be clearly indicated. Change requests can be submitted via the following methods:

Email: SSS-CSHelp@sbdinc.com

Fax: 1-877-835-1030

All order cancellations or changes will be subject to a cancellation fee as defined in Stanley's Terms and Conditions of Sale.

PRODUCTION SCHEDULING AND "DO NOT SHIP BEFORE" REQUESTS: All orders are scheduled for production and shipping based on current production lead times and availability. Scheduling is completed only when an order is released from both credit and pricing review.

Exceptions to this policy are made only when the PO is clearly marked: "Do Not Ship Before" followed by the date. (Required Date, Expected Date, etc. do not apply) These orders will be scheduled to ship on or after the date listed.

Changes to "Do Not Ship Before" dates are required in writing and should be sent to: SSS-CSHelp@sbdinc.com.

Be advised orders not clearly marked with a "Do Not Ship Before" designation will be payable within normal terms from the actual shipment date.

EXPEDITE REQUESTS:

- Expedite requests will be reviewed and accommodated by Stanley based on production lead times and availability.
- See the then current Stanley Quick Ship Program for details.

WHOLESALE PURCHASE: Distributors are also free to utilize Stanley's Authorized Wholesalers to purchase product. Stanley does not make any guarantee of availability or pricing for purchases from an Authorized Wholesaler and the discounts afforded to Distributor by Stanley shall not apply to purchases from an Authorized Wholesaler. The terms and conditions and price of product shall be mutually agreed between Distributor and Wholesaler.



STANLEY BEST ORDERING

ORDER ENTRY REQUIREMENTS: The following information is required for Stanley to successfully process an order for Stanley Best Products:

Orders Requiring Factory Master Key Services:

- Itemized Purchase Order (PO)
- Completed Keying Request Information Form
- Hardware Schedule in support of a construction project
- Stanley Approved Quote

Orders NOT Requiring Factory Master Key Services:

- Purchase Order
- General Contractor information (City/State/Zip)
- Stanley-Approved Quote

KEYING SYSTEM ORDERS: All orders of keying systems specifying delayed fulfillment must be fulfilled within twelve (12) months of the order date. Said request for fulfillment must include complete keying instructions for the order to be acknowledged with an estimated delivery date. Failure to properly request fulfillment of the order within twelve (12) months of the order date will make the order void and nonrefundable.

Pricing for all new construction key operated locks include the following:

- Combined or uncombined permanent cores will be provided with 2 keys per core
- "Core only" orders will be provided with 2 keys per core.

Pricing for all retrofit key operated locks include the following:

- Combined cores will be provided with 1 key per core.
- Uncombined cores will be provided with 0 keys. All keys will need to be purchased separately.

All new purchase orders should be e-mailed to your local Stanley Representative or SSSCHOrderEntry@sbdinc.com

HARDWARE SCHEDULE & NEW CONSTRUCTION PROJECT ORDERS: A hardware schedule should be submitted for all new construction projects. A hardware schedule is a listing of all builders hardware items related to a particular construction job. It is approved by the architect (or an entity performing that function). A hardware schedule of Stanley products is one in which the material ordered is compatible for installation as required in the schedule. Remember complete door schedules include door number, door location, and type of hardware. An example of a preferred hardware schedule format is illustrated below:

Project Sample			
Hardware Set 01			
1	SGL DOOR 101A	CORRIDOR 100 FROM CLASSROOM 101	90 DEG RHR
		3/0 x 7/0 x 1-3/4 HMF x SWD	
3	HINGES	FBB179 4.5 x 4.5	852
1	CLASSROOM LOCKSET	93K 7 R 14D S3 STD	828
1	CLOSER	D-4551 CS	689
1	KICKPLATE	8" x 34" x .050	630
3	MUTES		GREY

COMBINED CORE ONLY ORDERS: All Core-Only orders, in an amount of 25 cores or more, require a Hardware Schedule, Keying Request Information Form, and Itemized Purchase Order (PO).

LESS CORE LOCK ORDERS PURCHASED DIRECTLY FROM STANLEY: Less core lock orders generally apply to orders where the end user is providing their own permanent cores. All less core lock orders require a Hardware Schedule and a Stanley quote. This section does not apply to Stanley Distributors who are authorized to stock Best products.

CABINET LOCK ORDERS:

The following information must be provided for Cabinet Lock Orders:

- End User Name
- End User Address Information (Street/City/State/Zip)
- End User Phone
- End User Fax &/or E-Mail

DISTRIBUTOR PERMANENT KEYING

POLICY: Locks when ordered for construction projects to include "Final Keying" will be provided to Distributor with construction core access, whereby plastic thumb turns are supplied for use during construction. Additionally, brass construction cores can be purchased by the Distributor, upon request, to secure exterior doors or special interior doors.

The permanent masterkeyed cores are shipped directly to the end user upon written approval of the final keying. It is the responsibility of the Distributor to collect all temporary construction cores after use.

PROCESS:

- 1) Distributor places complete order with Stanley Customer Service, Indianapolis
- 2) Distributor, KSS, and End User Consultant (EUC) receive acknowledgement of order with expected ship date.
- 3) KSS/Distributor contacts the end user within a reasonable period of time after receipt of purchase order or acknowledgment to begin the permanent keying process.
- 4) KSS/Distributor works with end user to define keying requirements.
- 5) Once keying requirements are finalized and approved, production of cores and keys begins.
- 6) Cores and keys are shipped to end user or end user delegate (note: unless special arrangements are made the end user is responsible for permanent core installation).

Complete Order Checklist

- PO Number
- Hardware Schedule
- Completed Keying Request Information Form

The KSS/Distributor works directly with the end user to acquire keying instructions for the permanent masterkeyed cores and keys, including both new system design and existing system expansion, according to the project requirements. The KSS/Distributor also manages the process from keying instructions to delivery and can serve as a point of contact for information on the progress of permanent core/key delivery completion.



STANLEY BEST ORDERING (continued)

SERVICE DELIVERY:

Permanent Core delivery is contingent upon several factors such as:

- The negotiated delivery dates as determined between the end user, Distributor and Stanley during the keying review and design processes;
- End user's written approval of the keying instructions;
- Size and complexity of the keying system being produced; and
- Stanley's receipt of payment from the Distributor.

GENERAL:

- Remember to furnish door and location information for all "tag-in" orders (add-ons to initial project orders)
- If you have advance knowledge that your project will be phased and require multiple orders from Stanley, please include these details in your order.
- A master hardware schedule for phased projects is always preferred.

CONSTRUCTION CORES

CONSTRUCTION CORE ORDERS: All keyed locks shipped from Stanley for new construction projects in which cores have been ordered will receive disposable black plastic (non-keyed) construction cores at no additional charge.

Disposable black plastic cores for less-core orders may be purchased separately for \$1.50 net.

Standard brass (keyed-alike) construction cores may be purchased for a net price of \$8.00 each.

No further discount will be applied.

Brass construction cores shall be 7-pin, A keyway and have a GREEN face.

Brass construction cores are shipped with one operating key per ten (10) cores and one control key per twenty (20) cores; additional keys may be purchased for \$6.00 list.

Construction cores do not have the degree of security that the owner's permanent masterkeyed cores provide. Construction cores are used for controlling access to premises during construction and ARE NOT INTENDED FOR USE WHEN PREMISES ARE OCCUPIED OR FURNISHED IN ANY MANNER. When increased security is needed please contact your local Stanley Sales Representative.

CONSTRUCTION CORES AND KEYS		
Part Number:	Description	Net price each (if purchased separately)
7181139	Disposable Core (Black Plastic)	\$1.50 Net
7190246 (5c)	Standard Brass Keyed Alike 5c construction Core - Green Face	\$8.00 Net
7186163 (6p)	Standard Brass Keyed Alike 6 pin construction Core - Green Face	\$8.00 Net
7190224 (7p)	Standard Brass Keyed Alike 7 pin construction Core - Green Face	\$8.00 Net
7148872	Additional Operating Key	\$6.00 List
7147449	Additional Control Key	\$6.00 List

*No further discounting on Construction Core Net Pricing

RETURN OF CONSTRUCTION CORES: Brass construction cores may be returned for \$2.50 credit per re-usable core to be applied toward the next purchase. A Return Authorization (RA) Non-warranty must be obtained and accompany the returned material.

Stanley is not responsible for collection or return of construction cores.

STANLEY BEST PINS: Stanley Best pins shall be used solely in combination with Stanley Best Core products. Use of other pins may void any associated product warranty and may result in termination of the Distributor's agreement with Stanley, in Stanley's sole discretion.



RETURNED AUTHORIZATION (RA)

RA REQUESTS: A Return Authorization Form must be utilized to return defective products still under warranty or products deemed repairable by Stanley. All products returned to Stanley must have a correct Return Authorization (RA) number applied to the outside of the shipping carton. All products must be returned within sixty (60) calendar days of RA issue date. This process can take up to seven (7) days after product is received at Stanley's factory. If a defective product presents a security risk, an advance replacement may be requested.

RA PROCESS: Requests for warranty related returns can be initiated by submitting an email to RGACreditGRP@sbdinc.com.

The RA Request Form must be completed entirely to process an RA. The following information will be needed:

- End User Name
- Account Number
- Contact Name
- Phone Number
- Purchaser Order Number
- Sales Order Number
- Item Number
- Item Quantity
- Description of the Problem

1. Upon review and approval of the submitted RA request, a claim number is logged and provided back to the requestor by a Stanley Team member.
2. Once a claim number is issued, this number should be noted on all references and communications regarding the applicable situation to ensure a claim is easily identified.
3. Defective product should be returned to the address below. The shipment must be marked with the approved RA claim number to ensure prompt processing and attention. All shipping charges prepaid by customer.

Stanley Security Solutions, Inc.
Attn: Returns Department
6161 East 75th Street
Indianapolis, IN 46250

4. When material is received at Stanley's factory, Stanley will assess and determine the nature of the defect.
5. Defective goods are replaced upon Stanley's determination.
6. Credit for material and freight is issued only if deemed appropriate by Stanley. If approved, credit is initiated and a credit memo is mailed to the Distributor within fifteen (15) business days.

PURCHASE ORDERS:

A Purchase Order (PO) will be required if the Product is:

1. Defective and not under warranty, or
2. An advance replacement is required without verification of whether the product is defective and under warranty.

Please send Purchase Orders to the following:

- Preferred Method Email: RGACreditGRP@sbdinc.com
- Fax: 1-877-835-1030



RETURNED AUTHORIZATION (RA) NON-WARRANTY

RA POLICY: A Return Authorization Form must be utilized to return products that are not defective and otherwise in a resalable condition. Only goods with an invoice date of less than one (1) year will be considered for a non-warranty related return. All materials returned to Stanley for any reason (other than warranty), must have a correct Return Authorization (RA) number applied to the outside of the shipping carton. A thirty percent (30%) re-stocking charge (of the purchase price) will be applied to the Distributor's account for orders returned, including orders that were placed by customer in error. Transportation charges of returned goods must be prepaid by the Distributor. All goods must be returned within sixty (60) calendar days of RA issue date. All goods must be returned in original packaging and be in resalable condition. Product not returned in saleable condition is subject to disposal by Stanley with no credit issued. Commercial Hardware items that are special made to order items will not be returned under any circumstances.

RA PROCESS: Requests for non-warranty related returns can be initiated by submitting an email to **RGACreditGRP@sbdinc.com**.

The RA Request Form must be completed entirely to process an RA. The following information will be needed:

- End User Name
- Account Number
- Contact Name
- Phone Number
- Purchaser Order Number
- Sales Order Number
- Item Number
- Item Quantity
- Description of the Problem

1. Upon review and approval of the submitted RA request, a claim number is logged and provided back to the requestor by a Stanley Team member:
2. Once a claim number is issued, this number should be noted on all references and communications concerning said RA.
3. Product should be returned to the address below. The shipment must be marked with the approved RA claim number to ensure prompt processing and attention. All shipping charges prepaid by customer.

Stanley Security Solutions, Inc.
Attn: Returns Department
6161 East 75th Street
Indianapolis, IN 46250

4. The RA will be processed once material is received at Stanley's factory provided it is received in its original packaging and is in saleable condition.
5. Credit is issued to the Distributor account and a credit memo is mailed to the Distributor.

FULFILLMENT ISSUES

Any quality issues (missing parts, wrong parts, handling, finish, etc) should be submitted electronically to: RGACreditGRP@sbdinc.com or your Local Stanley Representative.

Please reference your original Purchase Order (PO) Number, Factory Order Number, Distributor Account, Contact Information (E-mail/Fax), and include a detailed description of the issue.

1) ITEMS MISSING FROM A SHIPMENT: If you have signed your shipment short, Stanley Customer Service will promptly issue a No Charge replacement order for the missing products.

If the shipment was not signed short but after review, Stanley Customer Service determines (based on shipping weights, packing lists, etc) that the order was indeed shipped short, a No Charge replacement will be issued.

If Stanley Customer Service cannot verify a shipping error, an advance replacement order will be entered, charged, and expedited to the Distributor. The quality issue will be forwarded to the Return Authorization Credit Group for resolution.

If it is determined that the item was omitted from the order due to a Stanley order entry error, a change order will be entered and expedited for the missing products.

Please see Stanley's price book for further detail.

2) WRONG ITEMS RECEIVED (parts, handling, function, finish, etc):

Advanced replacements will be issued for any wrong items received. **Such orders will be charged based on pricing/ discounts from the original order.** The issue will be forwarded to Stanley's Return Authorization Credit Group for resolution.

Any quality issue that is determined to be either a Stanley order entry and/or manufacturing error will have an advanced replacement order entered and will be expedited. An RA will be issued to return the incorrect products. No re-stock fee will apply for Stanley order entry and/or manufacturing errors.



KEYING REQUEST INFORMATION FORM

MUST BE SUBMITTED WITH COMPLETE INFORMATION, INCLUDING P.O. & HARDWARE SCHEDULE

CUSTOMER NUMBER:

Quote #: _____ Discount %: _____
If received
P.O. #: _____ Price List: _____

REQUIRED INFORMATION REGARDING STANLEY DISTRIBUTOR

Distributor: _____
Distributor P.O. #: _____
Distributor Account #: _____
Project Manager: _____
Project Manager Mobile: _____ Project Manager Email: _____
Address: _____
City, State, Zip: _____
Phone: _____ Fax: _____

REQUIRED INFORMATION REGARDING PROJECT CONTRACTOR

Contractor: _____
Job Name*: _____
Contact Person: _____
Contact Mobile: _____ Contact Email: _____

REQUIRED INFORMATION REGARDING THE END USER

Company*: _____
Contact Person*: _____
Contact Phone: _____ Contact Email: _____
School Name (if applicable): _____
School District (If applicable): _____
Permanent Core Due Date*: _____
Building Turnover Date: _____
Project Address*: _____
City, State, Zip*: _____
Phone*: _____ Fax: _____
End User Customer #: _____ Masterkey Account #: _____

Keyway: _____

NOTE: Failure to provide complete and accurate end user information will result in delays in processing and supply of permanent core and key orders. Failure to include this form with your order and the hardware schedule may result in the order being processed "less core".

*Required Field



STANLEY PATENTED MASTERKEY SYSTEM SECURITY AUTHORIZATION FORM

The purpose of this form is for the end user to designate representatives who are authorized to place an order for Stanley patented cores or keys and to confirm the correct shipping address for Stanley Patented product. It is the responsibility of the Distributor to ensure that the end user completes a Security Authorization Form and submits it to Stanley with each order.

The Stanley Patented Masterkey System provides a higher level of protection against unauthorized key duplication and crossovers. To help ensure that Stanley patented cores and keys do not end up in the possession of unauthorized personnel, Stanley will only authorize sales and shipment of Stanley patented cores and keys to the individuals noted on this form. Please complete this form carefully as Stanley and/or its Authorized Distributor will strictly adhere to this information.

END USER:

End User Name

Account Number

SECURITY AUTHORIZED PERSONNEL: Please provide the names of all security personnel who are authorized to place purchase orders for End User's Stanley Patented Masterkey Systems.

1.

_____ Name	_____ Street Address
_____ Title	_____ City, State, Zip
_____ Phone Number	_____ Email Address
_____ Fax Number	_____ Signature/Date

2.

_____ Name	_____ Street Address
_____ Title	_____ City, State, Zip
_____ Phone Number	_____ Email Address
_____ Fax Number	_____ Signature/Date

3.

_____ Name	_____ Street Address
_____ Title	_____ City, State, Zip
_____ Phone Number	_____ Email Address
_____ Fax Number	_____ Signature/Date



STANLEY PATENTED MASTERKEY SYSTEM SECURITY AUTHORIZATION FORM (continued)

AUTHORIZED DISTRIBUTOR: Please insert the name below of the Authorized Distributor that you assign and authorize to place orders for Stanley Patented Product on your behalf.

1. _____

Name	Street Address
_____	_____
Title	City, State, Zip
_____	_____
Signature	Phone Number / Email Address
_____	_____
Date	

SHIPPING ADDRESS: Please provide the address where you would like all Stanley Patented Product shipped.

Department

Street Address

City, State, Zip

ACCEPTABLE METHOD FOR PLACING ORDERS: please identify below the method that you authorize for placement of orders for Stanley Patented Product.

- Signature Verification** – Stanley may only accept purchase orders that have been signed by one of the individuals designated on this form by the End User. Stanley will verify that the signatures match before initiating activity on the order. Stanley will not initiate activity until the original P.O. has been received.
- Email Verification** – Stanley may accept electronic purchase orders from the email accounts designated on this form by the End User. Stanley will verify that the email account sending the purchase order has been designated as an authorized purchaser. Purchase orders received from accounts not listed will not be accepted.
- Fax Verification** – Stanley may accept purchase orders via fax from one of the individuals designated on this form by the End User. Stanley will verify that the individual placing the order has been designated as an authorized purchaser.

STANLEY MASTERKEY CODE & MASTERKEY SERVICE POLICY: In accordance with the Stanley Masterkey Code and Masterkey Service Policy, all Stanley Patented Masterkey Codes and combinations are available for distribution solely to end users and select Authorized Distributors. To assist in reducing the possibility of duplication within a Stanley Patented Masterkey System and ensure security, all Stanley Patented Masterkey Code extensions and next in series codes should be made or approved by Stanley Masterkey personnel and/or the Distributors that have been authorized by Stanley to have access to Stanley Patented Masterkey Codes, un-combinated cores and key blanks. Duplication or release of Stanley Patented Masterkey Codes to non-authorized people or organizations, including, but not limited to, unauthorized distributors, wholesalers, private locksmiths, other lock manufacturers, architects, or contractors violates Stanley’s ownership rights and is strictly prohibited

By signing below, End User acknowledges that 1) the information provided above is accurate and correct and 2) that any unauthorized use including, but not limited to, the transmission or dissemination of Stanley Patented Masterkey Codes, without the express written consent of Stanley is strictly prohibited.

End User Signature: _____

Title: _____ Date: _____



RETURN AUTHORIZATION FORM REQUEST

- Return for Replacement Return for Credit

Date of Request: _____
 Original Order: _____
 Date of Request: _____
 Original P.O.: _____
 Invoice #: _____
 Customer Name: _____
 Account Number: _____
 Address: _____
 City: _____
 State: _____ Zip: _____
 Contact Name: _____
 Email: _____
 Phone: _____

NATURE OF PROBLEM

- Manufacturing Defect
 Warranty Evaluation
 Missing Parts
 Wrong Materials Received
 Wrong Materials Ordered
 Wrong Quantity
 Return Inventory
 Other: _____

Note: All returns shall be subject to Stanley's current Terms of Sale and Warranty as outlined in Stanley's price catalog.

- Ship Replacement Material to Address Above Ship Replacement Material to Address on Order

DETAILED DESCRIPTION OF DEFECT OR REASON FOR RETURN

RETURN MATERIAL			
Line Item #	Quantity	Product Nomenclature	Product Description

Please e-mail completed form to RGACreditGrp@sbdinc.com or Fax to 1-888-214-1918





1.855.365.2407
bestaccess.com

STANLEY Security, a business division of Stanley Black & Decker, is a provider of integrated access control and security solutions for institutional, commercial and industrial businesses and organizations. STANLEY Security delivers a comprehensive suite of security products, software and integrated systems with a strong emphasis on service. STANLEY Security is committed to extending its position as a leading comprehensive resource for a broad and extensive array of solutions that span the entire security spectrum.